

TINA3-WWW

~70° wide beam. Assembly with holder, installation tape and location pins.

TECHNICAL SPECIFICATIONS:

Dimensions	Ø 16.1 mm
Height	6.9 mm
Fastening	tape, pin
ROHS compliant	yes ⓘ



MATERIAL SPECIFICATIONS:

Component	Type	Material	Colour	Finish
TINA3-WWW	Single lens	PMMA	clear	
TINA3-HLD-PIN-TAPE	Holder	PC	white	
TINA-TAPE3	Tape	Acrylic foam	black	

ORDERING INFORMATION:

Component		Qty in box	MOQ	MPQ	Box weight (kg)
CA12428_TINA3-WWW	Single lens	5750	230	230	8.2
» Box size: 451 x 241 x 298 mm					

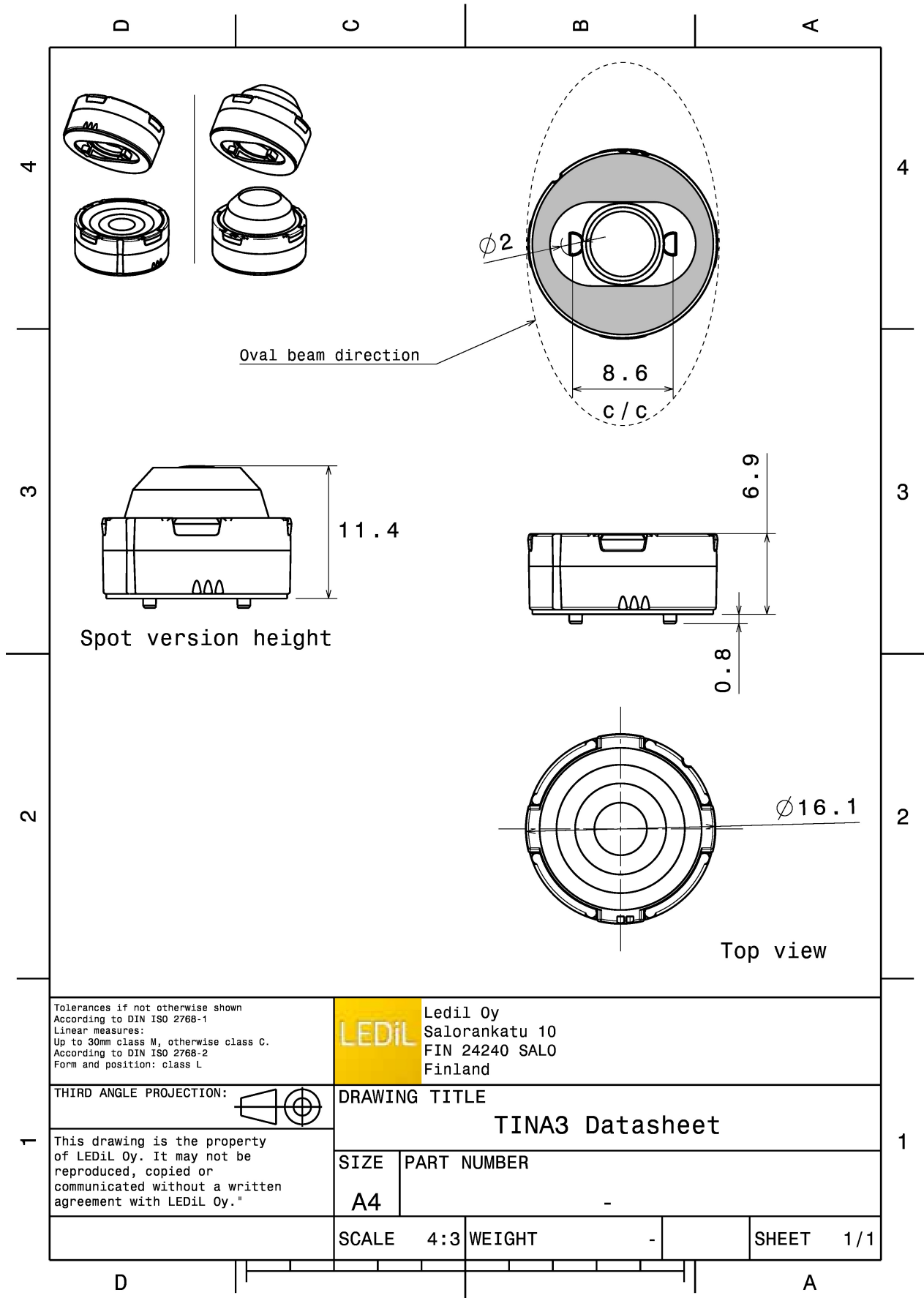

See also our general installation guide: www.ledil.com/installation_guide

PHOTOMETRIC DATA (MEASURED):

CREE → LED

LED XP-E2
 FWHM / FWTM 77.0° / 106.0°
 Efficiency 88 %
 Peak intensity 0.7 cd/lm
 LEDs/each optic 1
 Light colour White
 Required components:

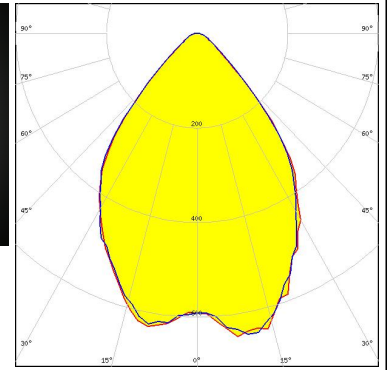
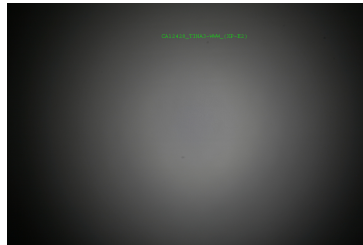

CREE → LED

LED XP-G
 FWHM / FWTM 69.0° / 102.0°
 Efficiency 87 %
 Peak intensity 0.7 cd/lm
 LEDs/each optic 1
 Light colour White
 Required components:

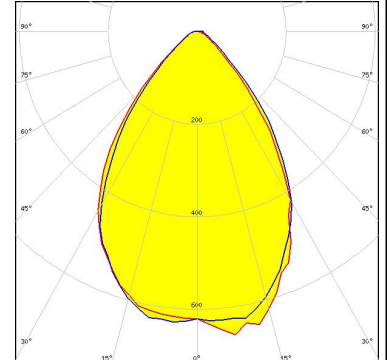

CREE → LED

LED XP-G2
 FWHM / FWTM 76.0° / 108.0°
 Efficiency 86 %
 Peak intensity 0.6 cd/lm
 LEDs/each optic 1
 Light colour White
 Required components:

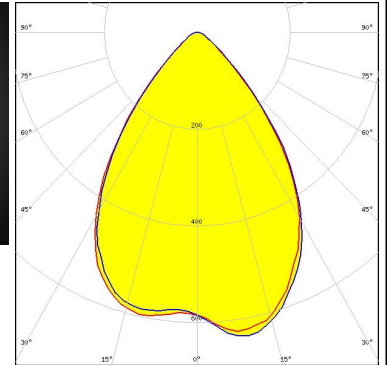
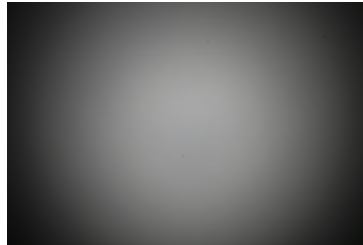

CREE → LED

LED XP-L HI
 FWHM / FWTM 74.0° / 105.0°
 Efficiency 91 %
 Peak intensity 0.7 cd/lm
 LEDs/each optic 1
 Light colour White
 Required components:

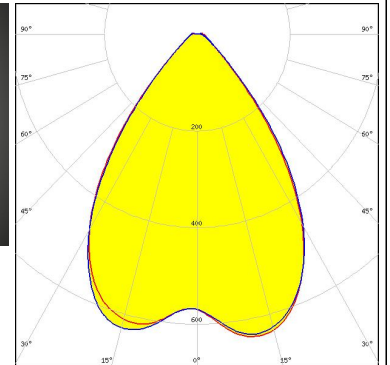
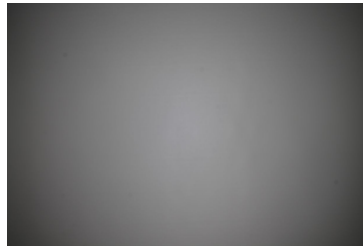

PHOTOMETRIC DATA (MEASURED):



LED XT-E
 FWHM / FWTM 68.0° / 102.0°
 Efficiency 85 %
 Peak intensity 0.7 cd/m
 LEDs/each optic 1
 Light colour White
 Required components:

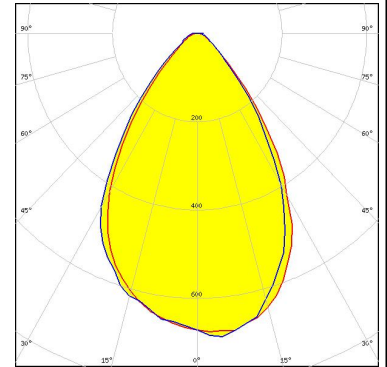

LED LUXEON A
 FWHM / FWTM 74.0° / 106.0°
 Efficiency 86 %
 Peak intensity 0.6 cd/m
 LEDs/each optic 1
 Light colour White
 Required components:

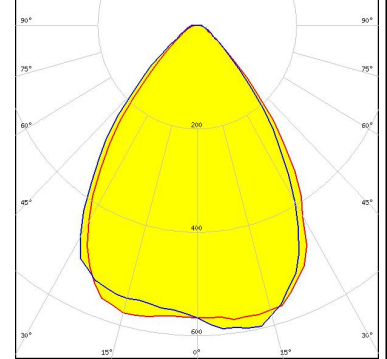



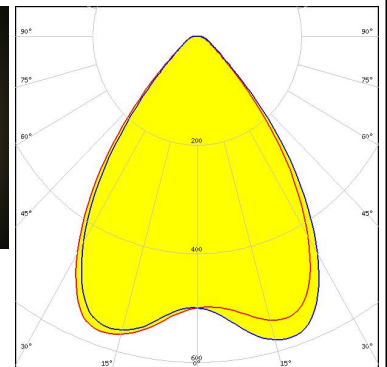
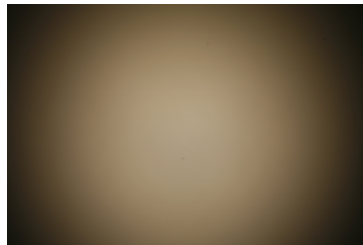

LED LUXEON T
 FWHM / FWTM 78.0° / 109.0°
 Efficiency 86 %
 Peak intensity 0.6 cd/m
 LEDs/each optic 1
 Light colour White
 Required components:

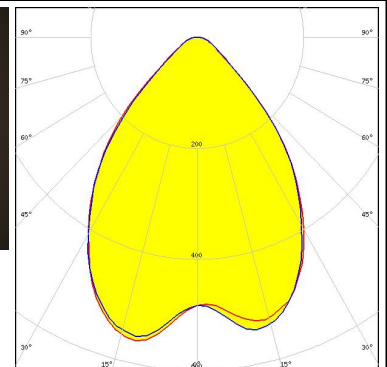
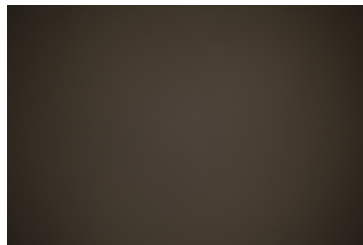

LED LUXEON TX
 FWHM / FWTM 79.0° / 115.0°
 Efficiency 87 %
 Peak intensity 0.6 cd/m
 LEDs/each optic 1
 Light colour White
 Required components:

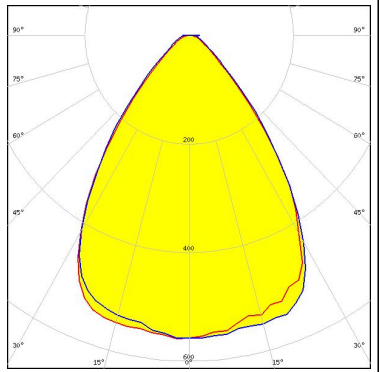

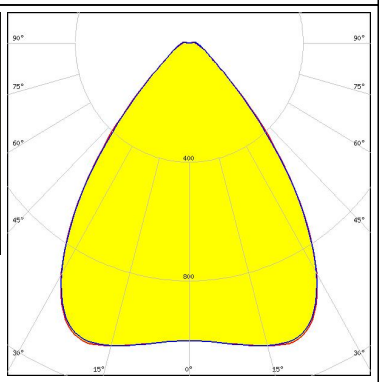
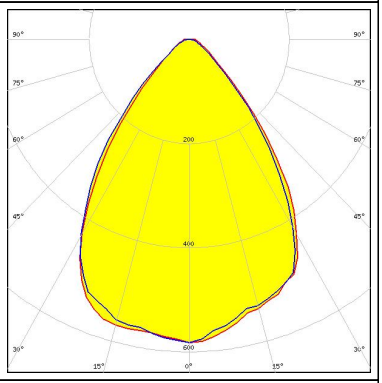
PHOTOMETRIC DATA (MEASURED):

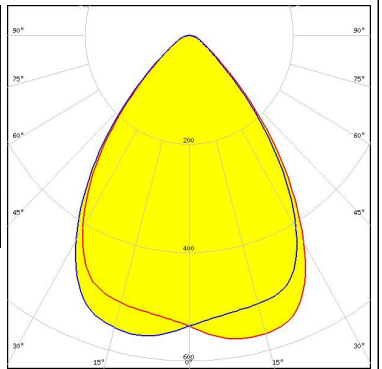
<p>NICHIA</p> <p>LED NVSxx19A FWHM / FWTM 75.0° / 106.0° Efficiency 83 % Peak intensity 0.6 cd/m LEDs/each optic 1 Light colour White Required components:</p>		
<p>NICHIA</p> <p>LED NVSxx19B/NVSxx19C FWHM / FWTM 79.0° / 113.0° Efficiency 90 % Peak intensity 0.6 cd/m LEDs/each optic 1 Light colour White Required components:</p>		
<p>OSRAM <small>Opto Semiconductors</small></p> <p>LED OSLON Square EC FWHM / FWTM 75.0° / 110.0° Efficiency 84 % Peak intensity 0.6 cd/m LEDs/each optic 1 Light colour White Required components:</p>		
<p>SAMSUNG</p> <p>LED LH351B FWHM / FWTM 76.0° / 110.0° Efficiency 86 % Peak intensity 0.6 cd/m LEDs/each optic 1 Light colour White Required components:</p>		

PHOTOMETRIC DATA (MEASURED):

SAMSUNG

LED LH351Z
FWHM / FWTM 85.0° / 121.0°
Efficiency 87 %
Peak intensity 0.5 cd/lm
LEDs/each optic 1
Light colour White
Required components:

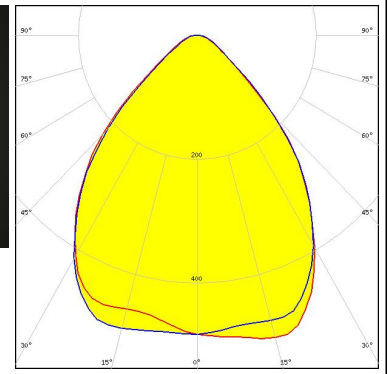

PHOTOMETRIC DATA (SIMULATED):



LED J Series 2835
FWHM / FWTM 80.0° / 104.0°
Efficiency 92 %
Peak intensity 0.6 cd/lm
LEDs/each optic 1
Light colour White
Required components:

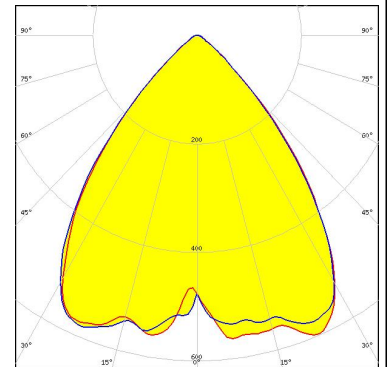

LED LUXEON 2835 Line
FWHM / FWTM 80.0° / 103.0°
Efficiency 93 %
Peak intensity 0.6 cd/lm
LEDs/each optic 1
Light colour White
Required components:

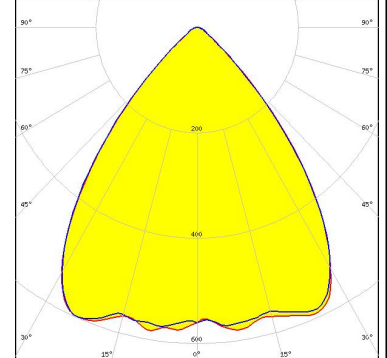

LED NCSxE17A
FWHM / FWTM 58.0° / 114.0°
Efficiency 80 %
Peak intensity 0.6 cd/lm
LEDs/each optic 4
Light colour White
Required components:

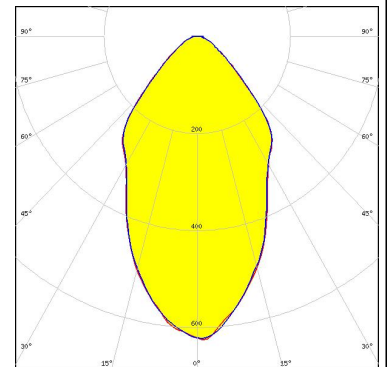

LED LM28xB Series
FWHM / FWTM 80.0° / 104.0°
Efficiency 92 %
Peak intensity 0.6 cd/lm
LEDs/each optic 1
Light colour White
Required components:

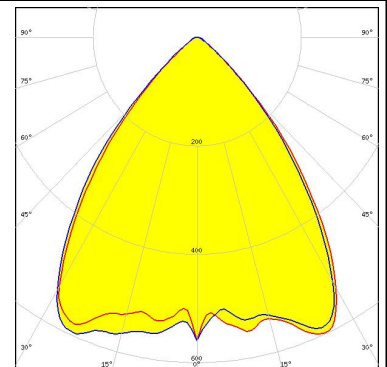

PHOTOMETRIC DATA (SIMULATED):



GENERAL INFORMATION:

NOTE: The typical beam angle will be changed by different color, chip size and chip position tolerance. The typical total beam angle is the full angle measured where the luminous intensity is half of the peak value.

MATERIALS:

As part of our continuous research and improvement processes, and to ensure the best possible quality and availability of our products, LEDiL reserves the right to change material grades without notice.

PRODUCT DATA USER AGREEMENT AND DISCLAIMER:

The measured data in the provided downloadable LEDiL Product Datasheets and Mechanical 2D-Drawings is rounded and provided as reference for planning. LEDiL Oy's optical specifications have been verified by conducting performance testing of the products in accordance with the company's quality system. The reported data are averaged results of multiple measurements with typical variation. LEDiL Oy reserves the right to without prior notification make changes and improvements to its products.

LEDiL Oy assumes neither warranty, nor guarantee nor any other liability of any kind for the contents and correctness of the provided data. The provided data has been generated with highest diligence but the provided data may in reality not represent the complete possible variation range of all intrinsic parameters. Therefore, in certain cases a deviation from the provided data could occur.

LEDiL Oy reserves the right to undertake technical changes of its products without further notification which could lead to changes in the provided data. LEDiL Oy assumes no liability of any kind for the possible deviation from any provided data or any other damage resulting from the usage of the provided data.

The user agrees to this disclaimer and user agreement with the download or usage of the provided files.

LEDiL Oy

Joensuunkatu 13
FI-24240 SALO
Finland

LEDiL Inc.

228 West Page Street
Suite D
Sycamore IL 60178
USA

Ledil Optics Technology (Shenzhen) Co., Ltd.

405 , Block B
Casic Motor Building
Shenzhen 518057
P.R.CHINA

Local sales and technical support

[www.ledil.com/
where_to_buy](http://www.ledil.com/where_to_buy)

Shipping locations

Salo, Finland
Hong Kong, China

Distribution Partners

[www.ledil.com/
where_to_buy](http://www.ledil.com/where_to_buy)

X-ON Electronics

Largest Supplier of Electrical and Electronic Components

Click to view similar products for [LED Lighting Lenses Assemblies](#) category:

Click to view products by [Ledil](#) manufacturer:

Other Similar products are found below :

[FCN12592_LE1-D-COP](#) [CA16129_OLGA-W](#) [CA16370_HB-SQ-W](#) [FN15972_RONDA-ZT45-C](#) [CS15759_HB-2X2MX-8-W](#)
[CA16435_LXP2-SS-WAS](#) [CN16210_GABRIELLA-MIDI-W](#) [CP17137_CARMEN-M2-C](#) [CA16015_STRADA-SQ-SCL](#) [CP17594_TINA-SC-](#)
[RS](#) [CS15767_HB-2X2MX-8-M](#) [CP10960_RGBX-SS](#) [CP12395_LXP3-W](#) [CP12939_LARISA-RS-CLIP16](#) [C14636_XTM-PF-ADAPTER](#)
[CA11819_STRADA-SQ-T-DW](#) [CA14508_G2-LXP2-D](#) [CA14601_VERONICA-SQ-MINI-RS](#) [FCP13895_SEANNA-A](#) [CP12943_LARISA-](#)
[O-CLIP16](#) [FP11124_LISA2-O-PIN](#) [CS14597_HB-IP-2X6-O](#) [CP14995_FLORENTINA-HLD-O](#) [CS15158_STRADA-IP-2X6-T4-B](#)
[CS16323_STRADELLA-IP-28-HB-M](#) [FN14976_STELLA-DWC2](#) [FN15264_STELLA-HB-WWW](#) [CA15584_ZORYA-MINI-TAPE](#)
[FA15229_ROSE-MRK-S](#) [FA15232_ROSE-MRK-M](#) [FA15233_ROSE-MRK-W](#) [FCN13552_CRYSTAL-RS](#) [FN15552_RONDA-W](#)
[FS15626_FLORENCE-3R-IP-Z90](#) [FS15786_FLORENCE-3R-IP-Z60](#) [FS15847_FLORENCE-3R-IP-O](#) [CA14505_G2-LXP2-RS2-P](#)
[FCN12775_IRIS-O](#) [CP15304_LARISA-RS-PIN](#) [FN15679_RONDA-S](#) [CA15519_VERONICA-SQ-MINI-D](#) [FP14414_LISA2-O-PIN](#)
[LL01CR-DF60L06-M2](#) [FN15993_RONDA-O](#) [FN15977_RONDA-WAS2](#) [CA14366_FLARE-MAXI-TAPE](#) [CA14442_VERONICA-SQ-W](#)
[CA14509_G2-LXP2-M-P](#) [CA15231_VERONICA-SQ-MINI-W](#) [FP11002_LISA2-W-PIN](#)