

**Product number CA13269_LAURA-SS-WAS**

Family	Laura	FWHM	Asymmetric degrees
Type	Assembly	Efficiency	92 %
LED	XP-E	cd/lm	11.600
Color	White	Gerber File	Available
Diameter	21.6 x 21.6 mm		
Height	13.1 mm		
Style	Square		
Optic Material	PMMA		
Holder Material	-		
Fastening	["tape"]		
Status	Production ready		

**Product number CA13271_LAURA-O-WAS**

Family	Laura	FWHM	Asymmetric degrees
Type	Assembly	Efficiency	84 %
LED	XP-E	cd/lm	3.000
Color	White	Gerber File	Available
Diameter	21.6 x 21.6 mm		
Height	13.1 mm		
Style	Square		
Optic Material	PMMA		
Holder Material	-		
Fastening	["tape"]		
Status	Production ready		

**Product number CA13307_LAURA-O-WAS-PIN**

Family	Laura	FWHM	Asymmetric degrees
Type	Assembly	Efficiency	84 %
LED	XP-E	cd/lm	3.000
Color	White	Gerber File	Available
Diameter	21.6 x 21.6 mm		
Height	13.1 mm		
Style	Square		
Optic Material	PMMA		
Holder Material	-		
Fastening	["pin", "tape"]		
Status	Production ready		

**Product number CP13308_LAURA-O-WAS-PG**

Family	Laura	FWHM	Asymmetric degrees
Type	Assembly	Efficiency	84 %
LED	XP-E	cd/lm	3.000
Color	White	Gerber File	Available
Diameter	21.6 x 21.6 mm		
Height	12.9 mm		
Style	Square		
Optic Material	PMMA,PC		
Holder Material	-		
Fastening	["glue", "pin"]		
Status	Production ready		

**Product number CP13311_LAURA-SS-WAS-PG**

Family	Laura	FWHM	Asymmetric degrees
Type	Assembly	Efficiency	92 %
LED	XP-E	cd/lm	11.600
Color	White	Gerber File	Available
Diameter	21.6 x 21.6 mm		
Height	12.9 mm		
Style	Square		
Optic Material	PC,PMMA		
Holder Material	-		
Fastening	["glue", "pin"]		
Status	Production ready		

**Product number CA13312_LAURA-SS-WAS-PIN**

Family	Laura	FWHM	Asymmetric degrees
Type	Assembly	Efficiency	92 %
LED	XP-E	cd/lm	11.600
Color	White	Gerber File	Available
Diameter	21.6 x 21.6 mm		
Height	13.1 mm		
Style	Square		
Optic Material	PMMA		
Holder Material	-		
Fastening	["tape", "pin"]		
Status	Production ready		

**Product number CA13639_G2-LAURA-SS-WAS-P**

Family	Laura	FWHM	Asymmetric degrees
Type	Assembly	Efficiency	92 %
LED	XP-E	cd/lm	11.600
Color	White	Gerber File	Available
Diameter	21.6 x 21.6 mm		
Height	13.1 mm		
Style	Square		
Optic Material	PMMA		
Holder Material	-		
Fastening	["tape", "pin"]		
Status	Production ready		

**Product number CA11353_LAURA-RS**

Family	Laura	FWHM	8 degrees
Type	Assembly	Efficiency	93 %
LED	XP-E	cd/lm	41.800
Color	Black	Gerber File	Available
Diameter	21.6 x 21.6 mm		
Height	13.1 mm		
Style	Square		
Optic Material	PMMA		
Holder Material	-		
Fastening	["tape"]		
Status	Production ready		

**Product number CA11959_LAURA-RS-PIN**

Family	Laura	FWHM	8 degrees
Type	Assembly	Efficiency	93 %
LED	XP-E	cd/lm	33.200
Color	White	Gerber File	Available
Diameter	21.6 x 21.6 mm		
Height	13.1 mm		
Style	Square		
Optic Material	PMMA		
Holder Material	-		
Fastening	["tape", "pin"]		
Status	Production ready		

**Product number CA13628_G2-LAURA-RS-P**

Family	Laura	FWHM	8 degrees
Type	Assembly	Efficiency	93 %
LED	XP-E	cd/lm	33.200
Color	White	Gerber File	Available
Diameter	21.6 x 21.6 mm		
Height	13.1 mm		
Style	Square		
Optic Material	PMMA		
Holder Material	-		
Fastening	["tape", "pin"]		
Status	Production ready		

**Product number CA11643_LAURA-SS**

Family	Laura	FWHM	11 degrees
Type	Assembly	Efficiency	93 %
LED	XP-E	cd/lm	16.500
Color	Black	Gerber File	Available
Diameter	21.6 x 21.6 mm		
Height	13.1 mm		
Style	Square		
Optic Material	PMMA		
Holder Material	-		
Fastening	["tape"]		
Status	Production ready		

**Product number CA12011_LAURA-SS-PIN**

Family	Laura	FWHM	11 degrees
Type	Assembly	Efficiency	93 %
LED	XP-E	cd/lm	16.500
Color	White	Gerber File	Available
Diameter	21.6 x 21.6 mm		
Height	13.1 mm		
Style	Square		
Optic Material	PMMA		
Holder Material	-		
Fastening	["tape", "pin"]		
Status	Production ready		

**Product number CA13630_G2-LAURA-SS-P**

Family	Laura	FWHM	11 degrees
Type	Assembly	Efficiency	93 %
LED	XP-E	cd/lm	16.500
Color	White	Gerber File	Available
Diameter	21.6 x 21.6 mm		
Height	13.1 mm		
Style	Square		
Optic Material	PMMA		
Holder Material	-		
Fastening	["tape", "pin"]		
Status	Production ready		

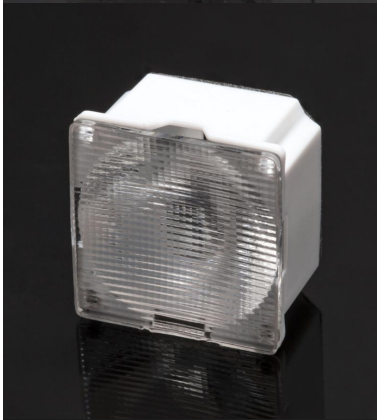
**Product number CA13637_G2-LAURA-O90-P**

Family	Laura	FWHM	11+40 degrees
Type	Assembly	Efficiency	91 %
LED	XP-E	cd/lm	6.290
Color	White	Gerber File	Available
Diameter	21.6 x 21.6 mm		
Height	13.1 mm		
Style	Square		
Optic Material	PMMA		
Holder Material	-		
Fastening	["tape", "pin"]		
Status	Production ready		

**Product number CA11360_LAURA-D**

Family	Laura	FWHM	13 degrees
Type	Assembly	Efficiency	93 %
LED	XP-E	cd/lm	9.300
Color	Black	Gerber File	Available
Diameter	21.6 x 21.6 mm		
Height	13.1 mm		
Style	Square		
Optic Material	PMMA		
Holder Material	-		
Fastening	["tape"]		
Status	Production ready		

**Product number CA11365_LAURA-O**

Family	Laura	FWHM	13+40 degrees
Type	Assembly	Efficiency	91 %
LED	XP-E	cd/lm	4.100
Color	Black	Gerber File	Available
Diameter	21.6 x 21.6 mm		
Height	13.1 mm		
Style	Square		
Optic Material	PMMA		
Holder Material	-		
Fastening	["tape"]		
Status	Production ready		

**Product number CA11960_LAURA-D-PIN**

Family	Laura	FWHM	13 degrees
Type	Assembly	Efficiency	93 %
LED	XP-E	cd/lm	9.300
Color	White	Gerber File	Available
Diameter	21.6 x 21.6 mm		
Height	13.1 mm		
Style	Square		
Optic Material	PMMA		
Holder Material	-		
Fastening	["tape", "pin"]		
Status	Production ready		

**Product number CA13629_G2-LAURA-D-P**

Family	Laura	FWHM	13 degrees
Type	Assembly	Efficiency	93 %
LED	XP-E	cd/lm	9.300
Color	White	Gerber File	Available
Diameter	21.6 x 21.6 mm		
Height	13.1 mm		
Style	Square		
Optic Material	PMMA		
Holder Material	-		
Fastening	["tape", "pin"]		
Status	Production ready		

**Product number CA13635_LAURA-O-90-PIN**

Family	Laura	FWHM	13+40 degrees
Type	Assembly	Efficiency	91 %
LED	XP-E	cd/lm	4.800
Color	White	Gerber File	Available
Diameter	21.6 x 21.6 mm		
Height	13.1 mm		
Style	Square		
Optic Material	PMMA		
Holder Material	-		
Fastening	["tape", "pin"]		
Status	Production ready		

**Product number CA11355_LAURA-M**

Family	Laura	FWHM	30 degrees
Type	Assembly	Efficiency	83 %
LED	XP-E	cd/lm	2.690
Color	Black	Gerber File	Available
Diameter	21.6 x 21.6 mm		
Height	13.1 mm		
Style	Square		
Optic Material	PMMA		
Holder Material	-		
Fastening	["tape"]		
Status	Production ready		

**Product number CA11837_LAURA-M-PIN**

Family	Laura	FWHM	30 degrees
Type	Assembly	Efficiency	92 %
LED	XP-E	cd/lm	2.600
Color	White	Gerber File	Available
Diameter	21.6 x 21.6 mm		
Height	13.1 mm		
Style	Square		
Optic Material	PMMA		
Holder Material	-		
Fastening	["tape", "pin"]		
Status	Production ready		

**Product number CA13627_G2-LAURA-M-P**

Family	Laura	FWHM	30 degrees
Type	Assembly	Efficiency	92 %
LED	XP-E	cd/lm	2.600
Color	White	Gerber File	Available
Diameter	21.6 x 21.6 mm		
Height	13.1 mm		
Style	Square		
Optic Material	PMMA		
Holder Material	-		
Fastening	["tape", "pin"]		
Status	Production ready		

**Product number CA12012_LAURA-O-PIN**

Family	Laura	FWHM	40+13 degrees
Type	Assembly	Efficiency	91 %
LED	XP-E	cd/lm	4.800
Color	White	Gerber File	Available
Diameter	21.6 x 21.6 mm		
Height	13.1 mm		
Style	Square		
Optic Material	PMMA		
Holder Material	-		
Fastening	["tape", "pin"]		
Status	Production ready		

**Product number CA13631_G2-LAURA-O-P**

Family	Laura	FWHM	40+13 degrees
Type	Assembly	Efficiency	91 %
LED	XP-E	cd/lm	4.800
Color	White	Gerber File	Available
Diameter	21.6 x 21.6 mm		
Height	13.1 mm		
Style	Square		
Optic Material	PMMA		
Holder Material	-		
Fastening	["tape", "pin"]		
Status	Production ready		

**Product number CA13634_G2-LAURA-W-P**

Family	Laura	FWHM	45 degrees
Type	Assembly	Efficiency	86 %
LED	XP-E	cd/lm	1.500
Color	White	Gerber File	Available
Diameter	21.6 x 21.6 mm		
Height	13.1 mm		
Style	Square		
Optic Material	PMMA		
Holder Material	-		
Fastening	["tape", "pin"]		
Status	Production ready		

**Product number CA12344_LAURA-W-PIN**

Family	Laura	FWHM	47 degrees
Type	Assembly	Efficiency	92 %
LED	XP-E	cd/lm	1.700
Color	White	Gerber File	Available
Diameter	21.6 x 21.6 mm		
Height	13.1 mm		
Style	Square		
Optic Material	PMMA		
Holder Material	-		
Fastening	["tape", "pin"]		
Status	Production ready		

**Product number CA11766_LAURA-WW**

Family	Laura	FWHM	66 degrees
Type	Assembly	Efficiency	86 %
LED	XP-E	cd/lm	0.700
Color	Black	Gerber File	Available
Diameter	21.6 x 21.6 mm		
Height	13.1 mm		
Style	Square		
Optic Material	PMMA		
Holder Material	-		
Fastening	["tape"]		
Status	Production ready		

**Product number CA12325_LAURA-WW-PIN**

Family	Laura	FWHM	66 degrees
Type	Assembly	Efficiency	86 %
LED	XP-E	cd/lm	0.700
Color	White	Gerber File	Available
Diameter	21.6 x 21.6 mm		
Height	13.1 mm		
Style	Square		
Optic Material	PMMA		
Holder Material	-		
Fastening	["tape", "pin"]		
Status	Production ready		

**Product number CA13633_G2-LAURA-WW-P**

Family	Laura	FWHM	66 degrees
Type	Assembly	Efficiency	86 %
LED	XP-E	cd/lm	0.700
Color	White	Gerber File	Available
Diameter	21.6 x 21.6 mm		
Height	13.1 mm		
Style	Square		
Optic Material	PMMA		
Holder Material	-		
Fastening	["tape", "pin"]		
Status	Production ready		

**Product number CA11525_LAURA-R-W**

Family	Laura	FWHM	71 degrees
Type	RefAssy	Efficiency	70 %
LED	XP-E	cd/lm	0.520
Color	Black	Gerber File	Available
Diameter	21.6 x 21.6 mm		
Height	13.1 mm		
Style	Square		
Optic Material	-		
Holder Material	-		
Fastening	["tape"]		
Status	Production ready		

**Product number CA13636_G2-LAURA-R-XW-P**

Family	Laura	FWHM	71 degrees
Type	RefAssy	Efficiency	84 %
LED	XP-E	cd/lm	0.700
Color	White	Gerber File	Available
Diameter	21.6 x 21.6 mm		
Height	13.1 mm		
Style	Square		
Optic Material	-		
Holder Material	-		
Fastening	["tape", "pin"]		
Status	Production ready		

**Product number CA12981_LAURA-R-XW**

Family	Laura	FWHM	72 degrees
Type	RefAssy	Efficiency	86 %
LED	XP-E	cd/lm	0.600
Color	Black	Gerber File	Available
Diameter	21.6 x 21.6 mm		
Height	13.1 mm		
Style	Square		
Optic Material	-		
Holder Material	-		
Fastening	["tape"]		
Status	Production ready		



Product number CA12984_LAURA-R-XW-PIN

Family	Laura	FWHM	72 degrees
Type	RefAssy	Efficiency	86 %
LED	XP-E	cd/lm	0.600
Color	White	Gerber File	Available
Diameter	21.6 x 21.6 mm		
Height	13.1 mm		
Style	Square		
Optic Material	-		
Holder Material	-		
Fastening	["tape", "pin"]		
Status	Production ready		

NOTE: The typical divergence will be changed by different color, chip size and chip position tolerance. The typical total divergence is the full angle measured where the luminous intensity is half of the peak value.



PRODUCT DATASHEET

Laura series

last update 9/7/2013

GENERAL INFORMATION

- Product series especially designed & optimized for XP-E series of LEDs.
- Special care taken to make light distribution as uniform as possible.
- Lens material optical grade PMMA with high UV and temperature resistance. Allows use of high current and temperature conditions.

Please find more information about used material from below:

http://ledil.fi/sites/default/files/Documents/Technical/Material/PMMA%20N%20UL94_Yellow%20Card.pdf

<http://ledil.fi/sites/default/files/Documents/Technical/Material/PMMA%20N%20PLEXIGLAS-Datasheet.pdf>

Relative intensity of CA12981_LAURA-REF-XW_(X)

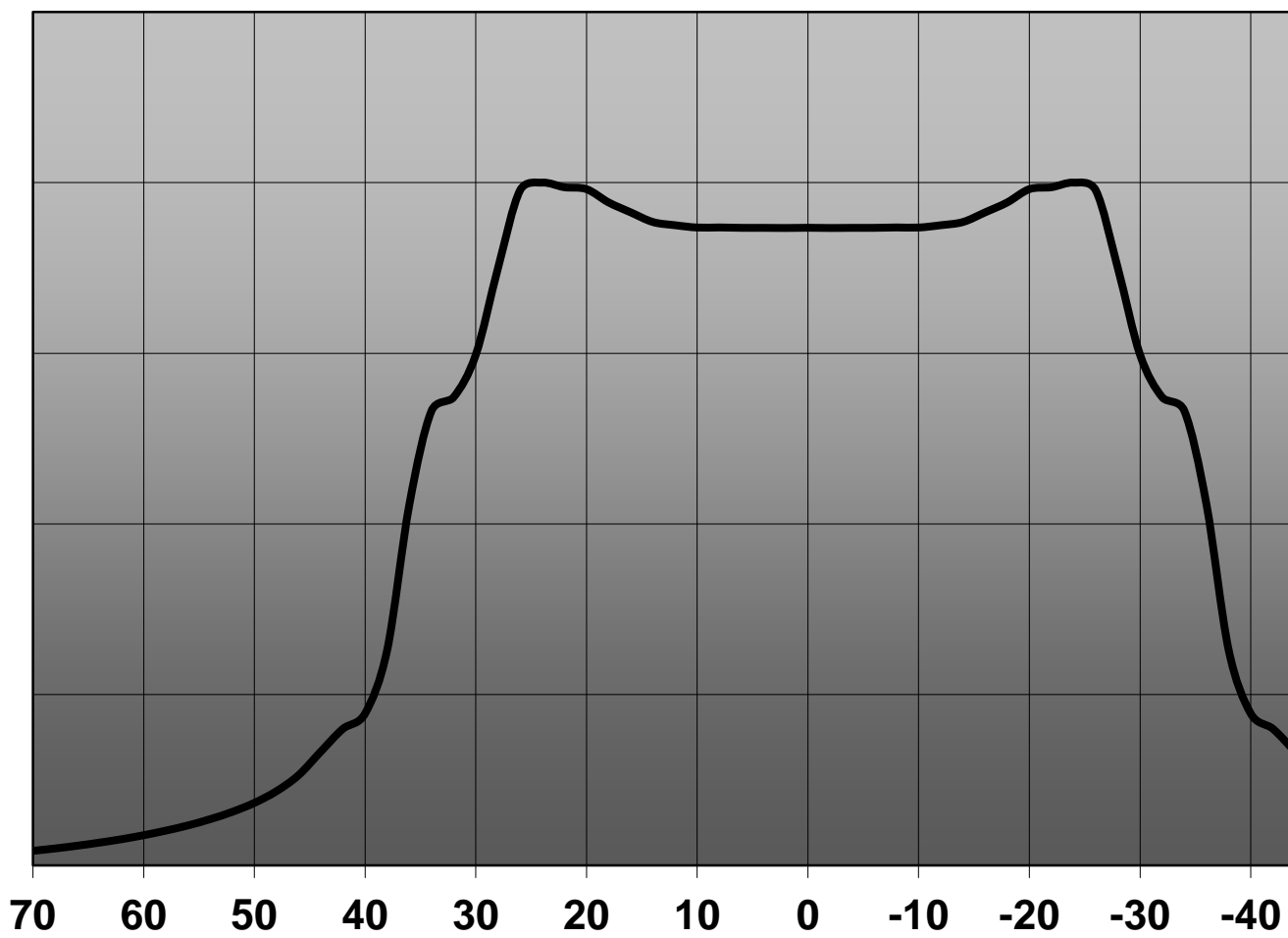

Relative intensity of CA12984_LAURA-REF-XW-PI
(XP-E)

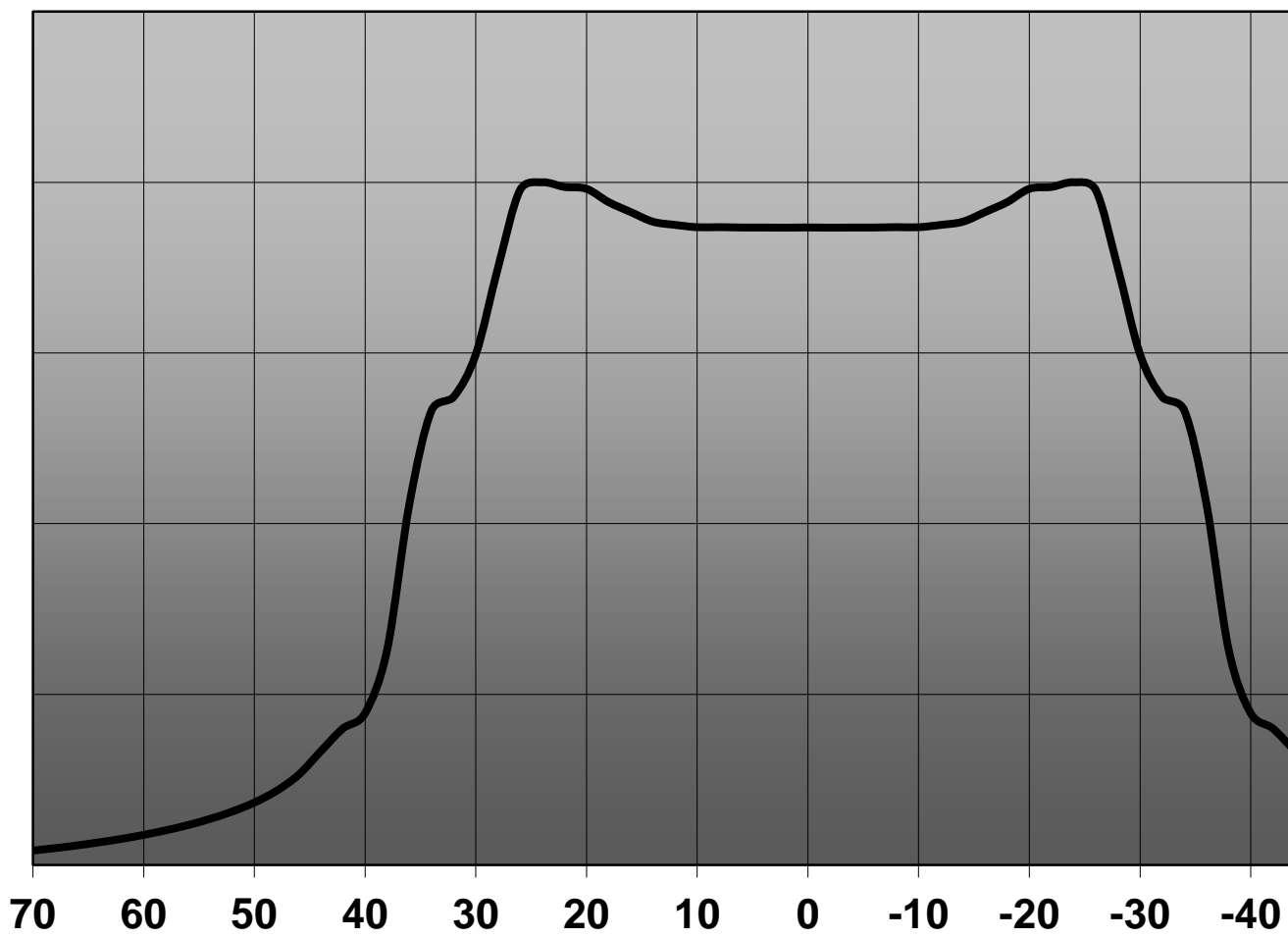

D

C

B

A

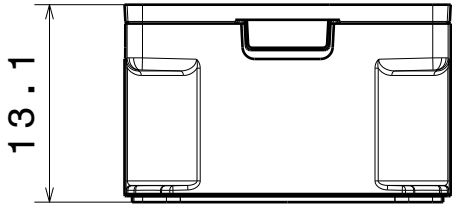

Front View

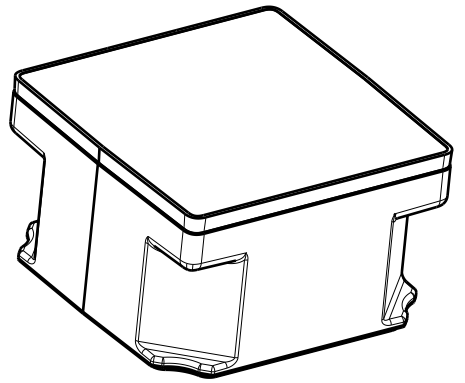

Isometric view

Oval Beam Direction

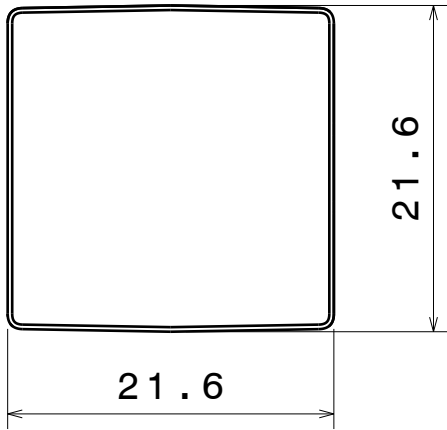

Top view

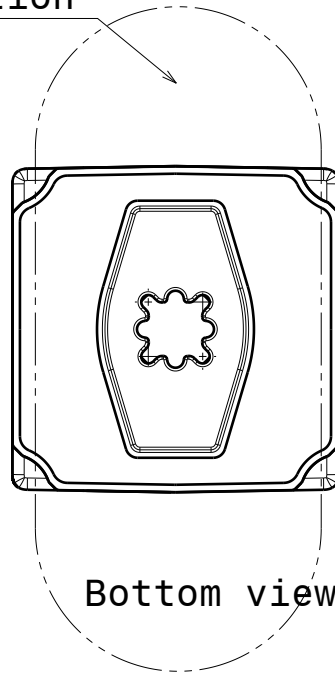

Bottom view

This drawing is our property.
It can't be reproduced
or communicated without
our written agreement.



Ledil Oy
Salorankatu 10
FIN 24240 SALO
Finland

DRAWING TITLE Mechanical Drawing

DRAWN BY
ks

DATE
08.11.2012

LAURA-XP

CHECKED BY
as

DATE
-

SIZE A4 PART NUMBER

REV
001

DESIGNED BY
-

DATE
-

SCALE 2:1 WEIGHT SHEET 1/1

D

A

4

4

3

3

2

2

1

1

Luminaire: Ledil Oy CA13269_LAURA-SS-WAS_(XP-E) Efficiency=92%
Lamps: 1 x Cree XP-E 70lm @ 250mA

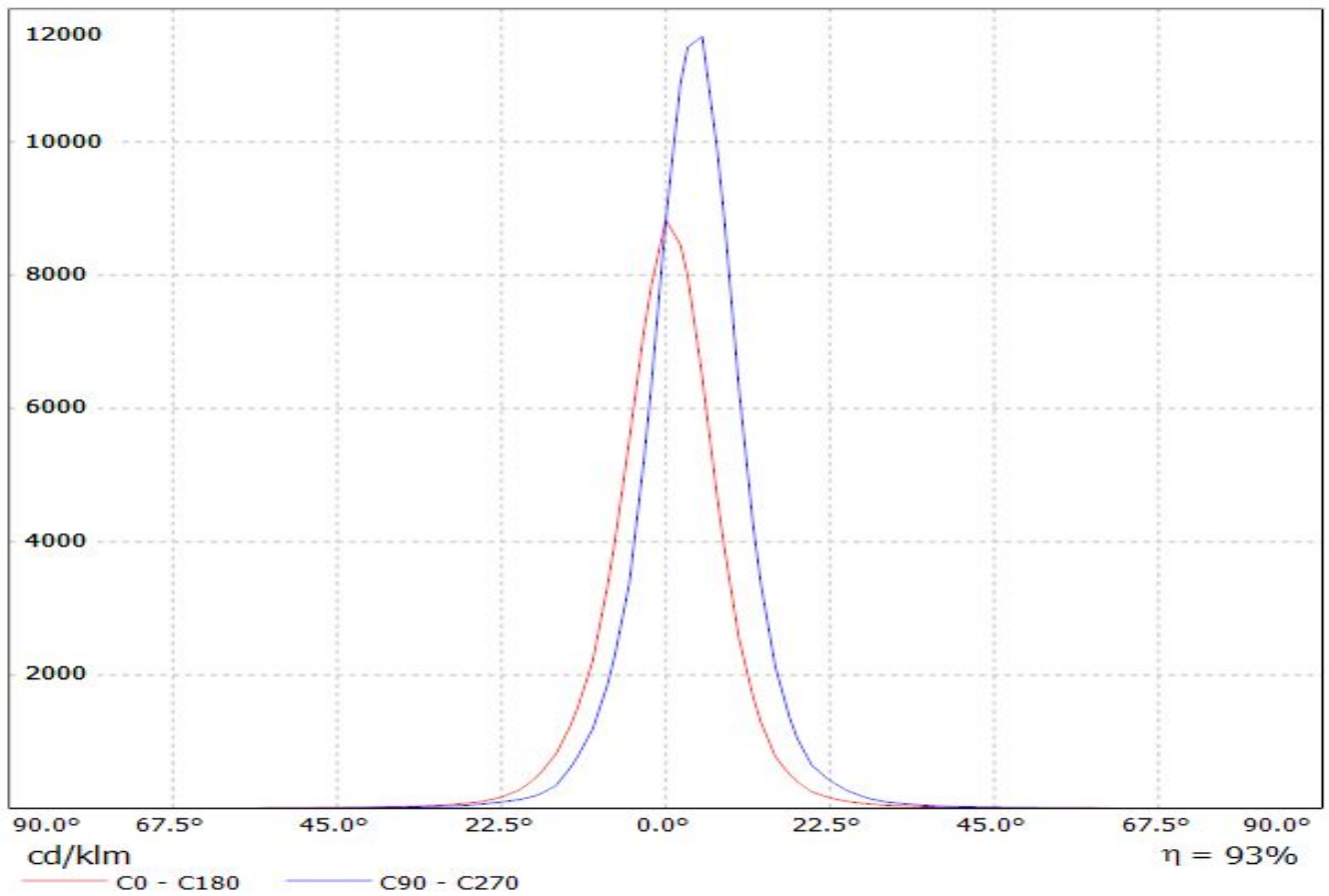

Luminaire: Ledil Oy CA13271_LAURA-O-WAS_(XP-E) Efficiency=84%
Lamps: 1 x Cree XP-E 70lm @ 250mA

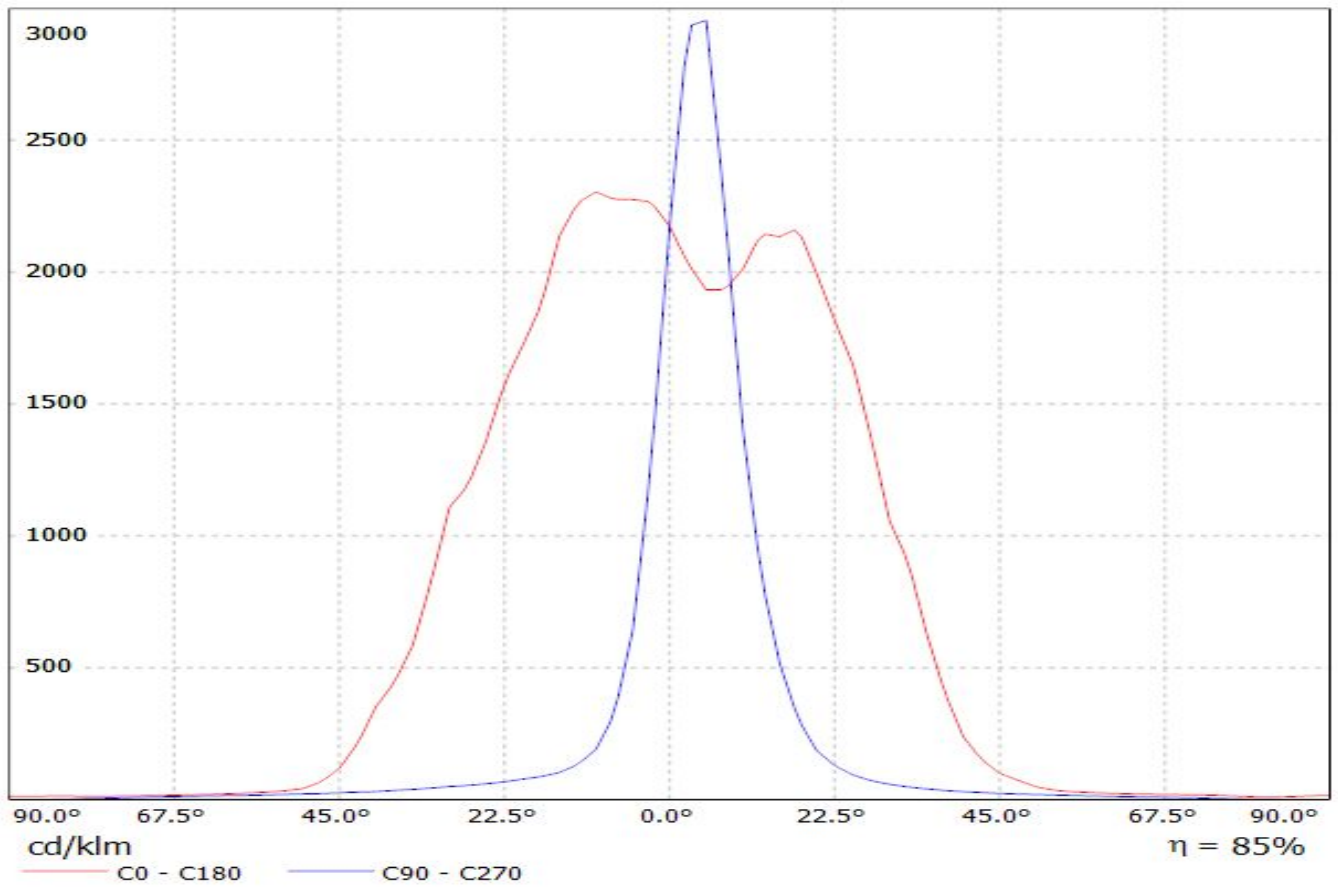

Luminaire: Ledil Oy CP13308&CA13307_LAURA-O-WAS (Cree XP-E 70lm @ 250mA) Efficiency=84%
Lamps: 1 x Cree XP-E 70lm @ 250mA

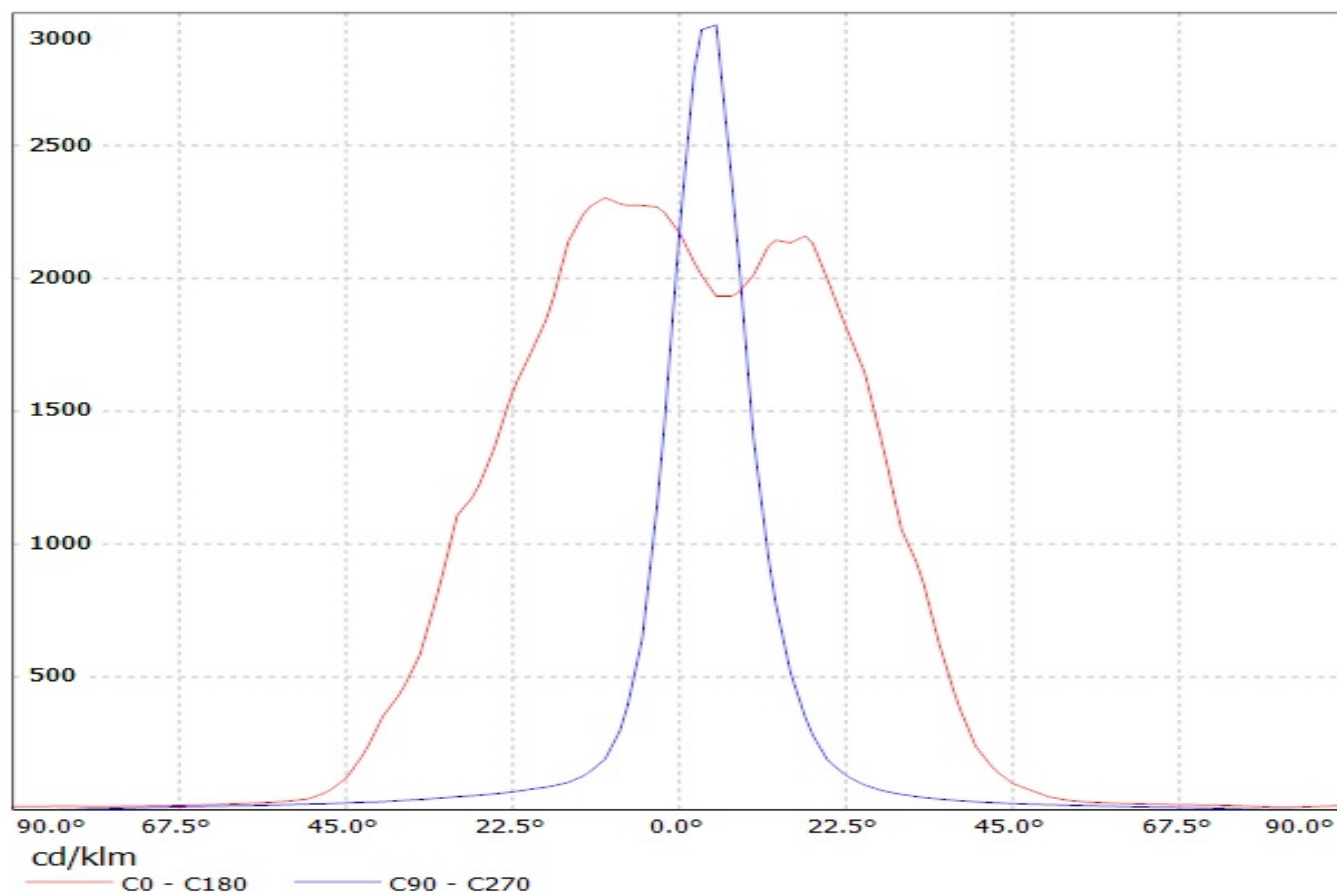

Luminaire: Ledil Oy CP13308&CA13307_LAURA-O-WAS (Cree XP-E 70lm @ 250mA) Efficiency=84%
Lamps: 1 x Cree XP-E 70lm @ 250mA

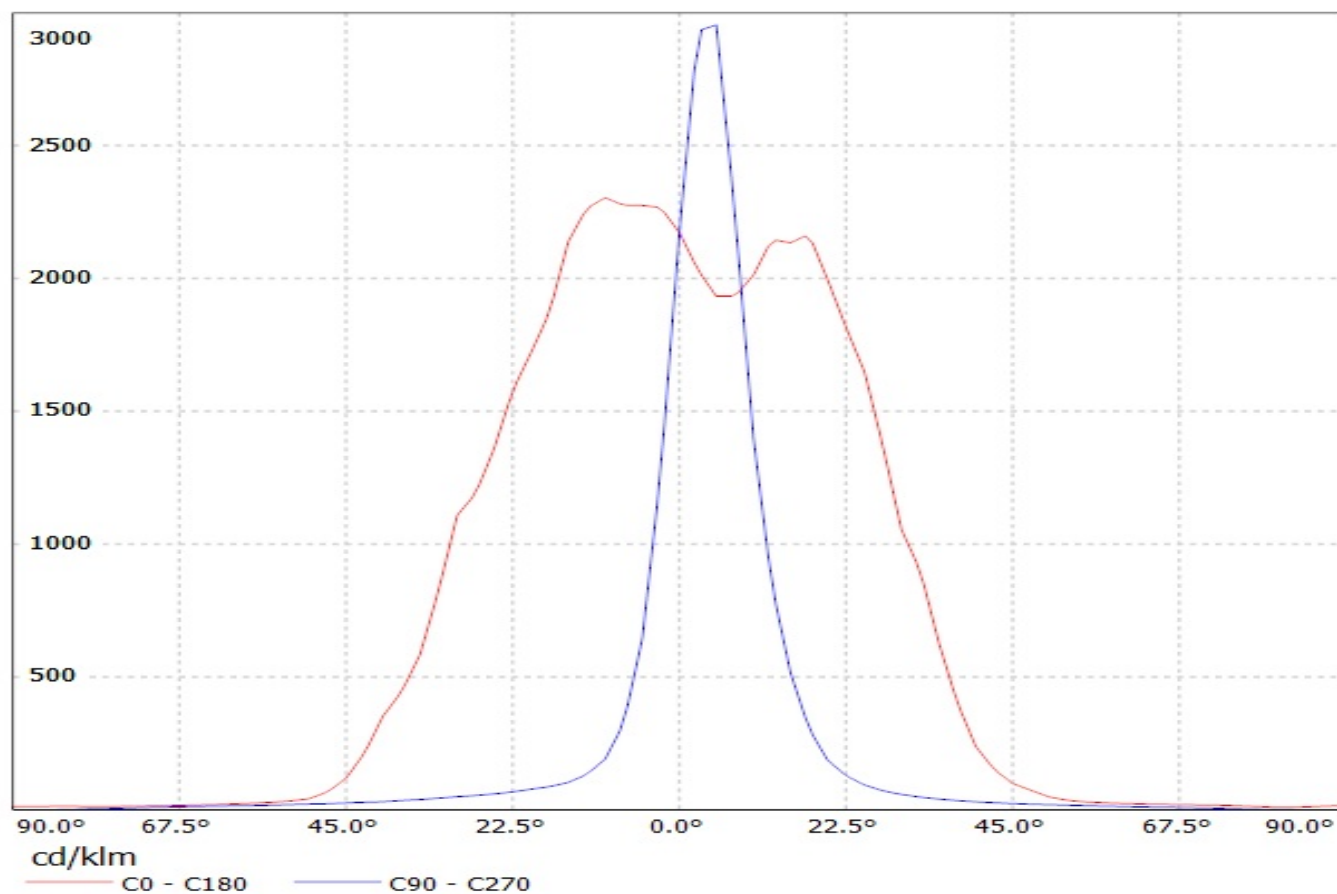

Luminaire: Ledil Oy CP13311&CA13312_LAURA-SS-WAS (Cree XP-E 70lm @ 250mA) Efficiency=92%
Lamps: 1 x Cree XP-E 70lm @ 250mA

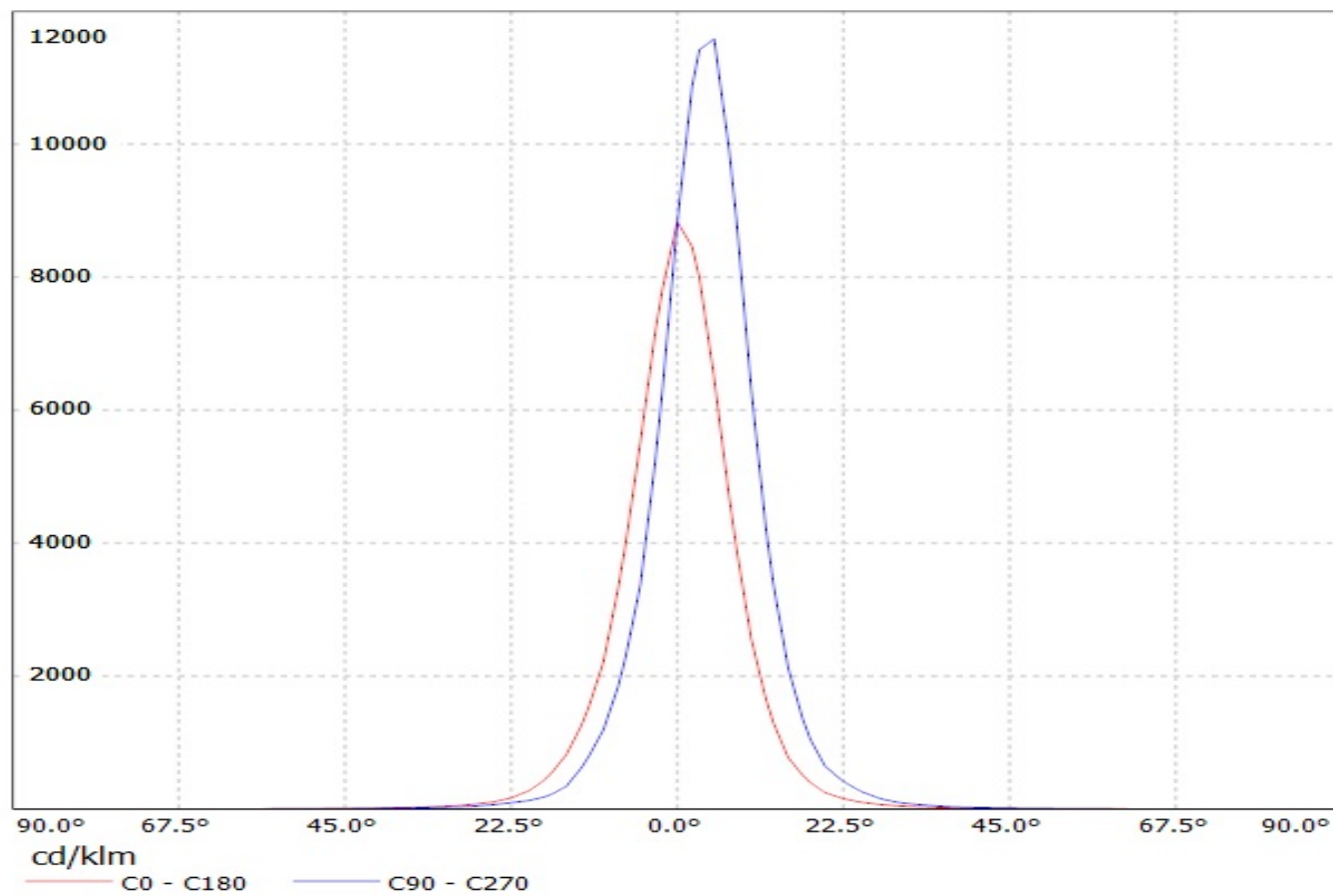

Luminaire: Ledil Oy CP13311&CA13312_LAURA-SS-WAS (Cree XP-E 70lm @ 250mA) Efficiency=92%
Lamps: 1 x Cree XP-E 70lm @ 250mA

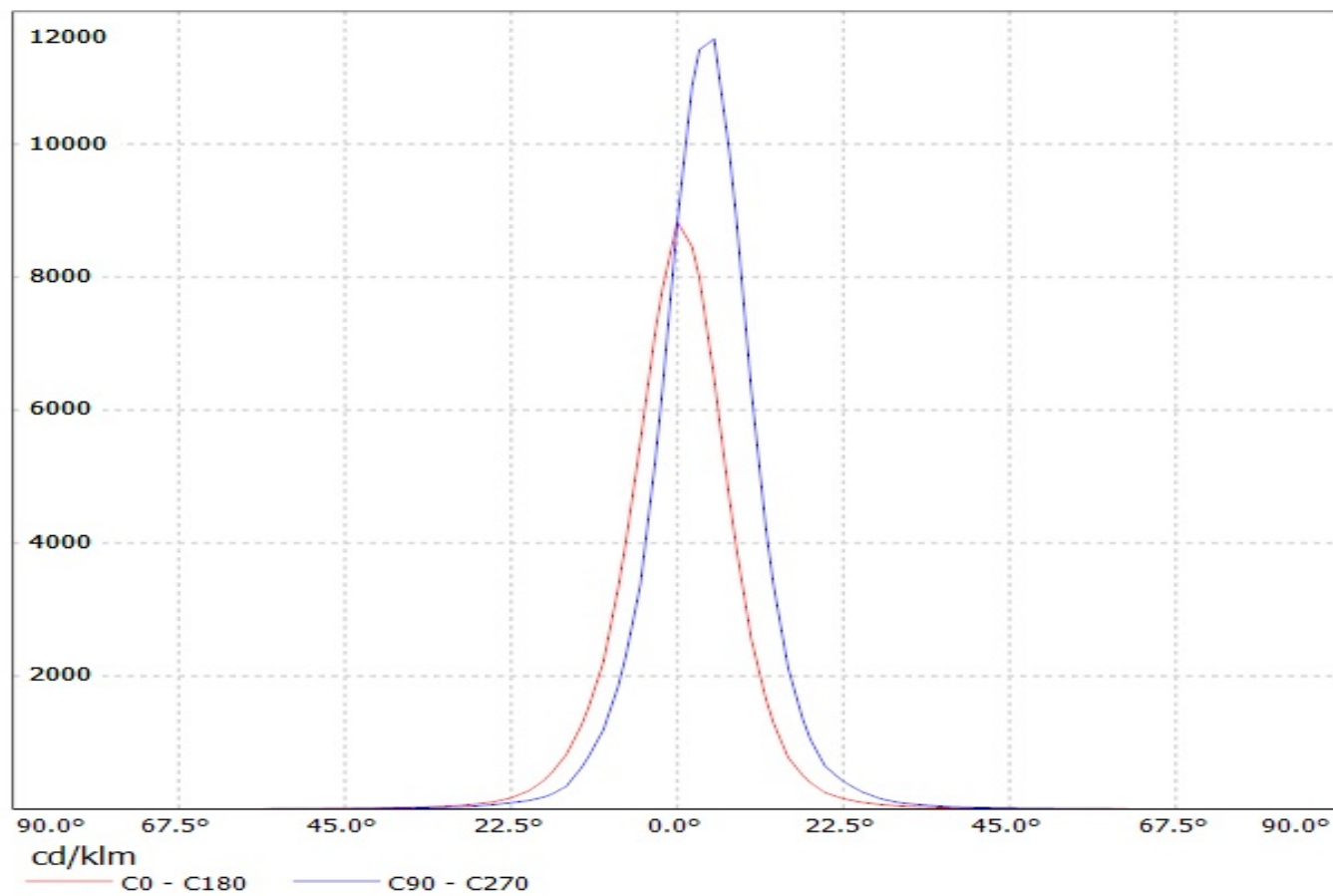

Ledil Oy CA11353_Laura-RS-XP-tape CA11353_Laura-RS-XP-tape / LDC (Linear)

Luminaire: Ledil Oy CA11353_Laura-RS-XP-tape CA11353_Laura-RS-XP-tape
Lamps: 1 x Cree XP-E (White)

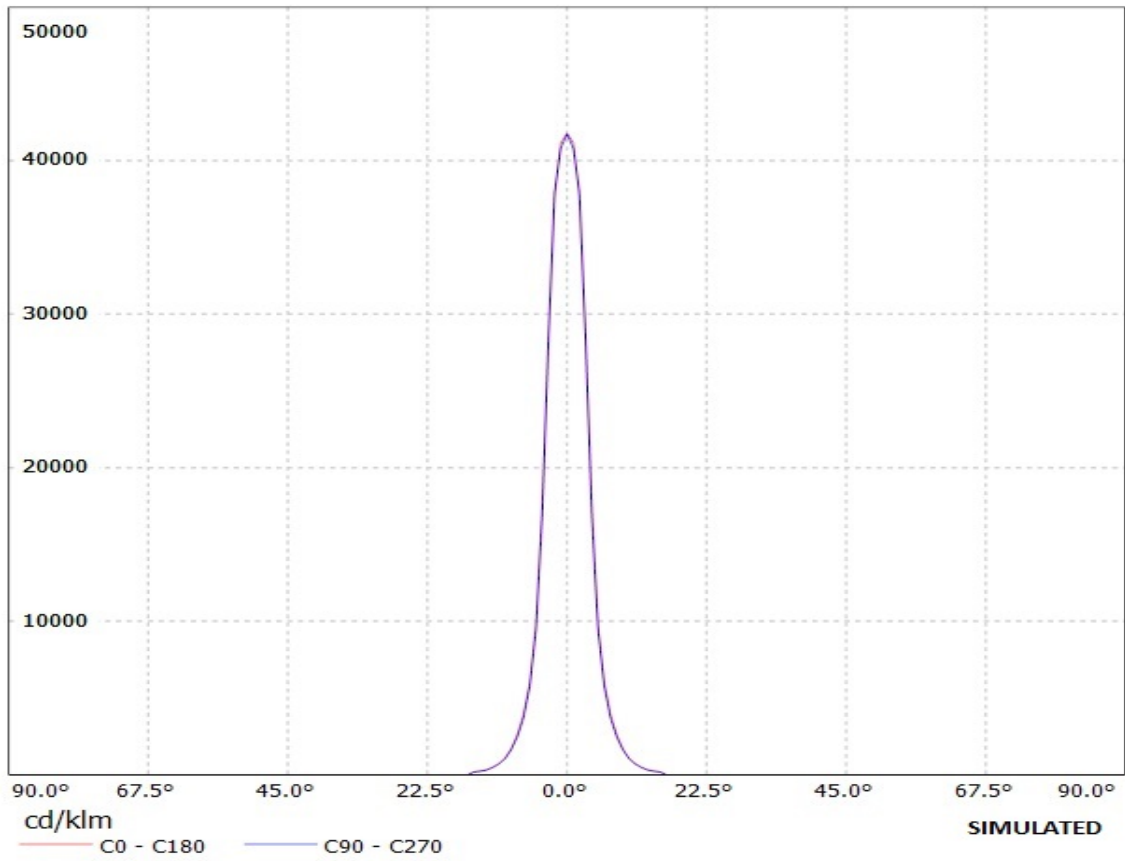

Ledil Laura-RS-Pin-XP Laura-RS-Pin-XP / LDC (Linear)

Luminaire: Ledil Laura-RS-Pin-XP Laura-RS-Pin-XP
Lamps: 1 x LED Module

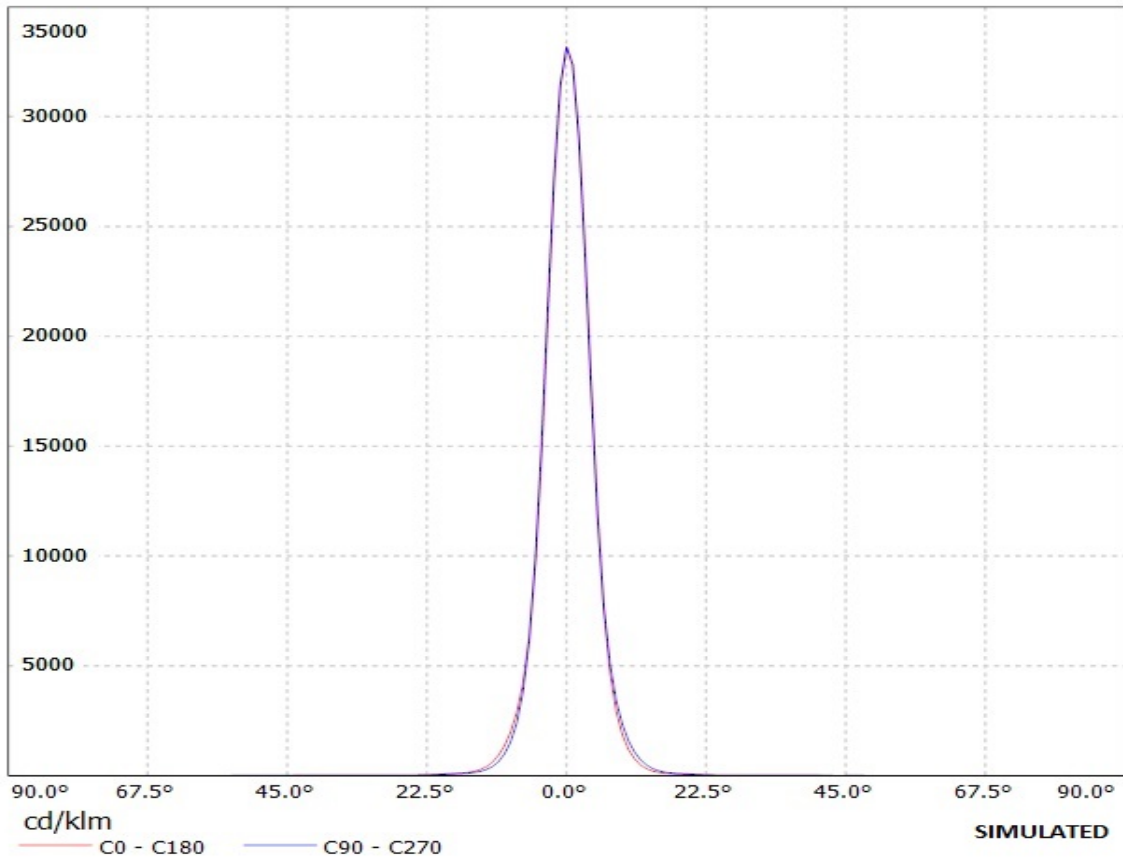

Ledil Oy CA11643_Laura-SS-XP CA11643_Laura-SS-XP / LDC (Linear)

Luminaire: Ledil Oy CA11643_Laura-SS-XP CA11643_Laura-SS-XP
Lamps: 1 x Cree XP-E(white)

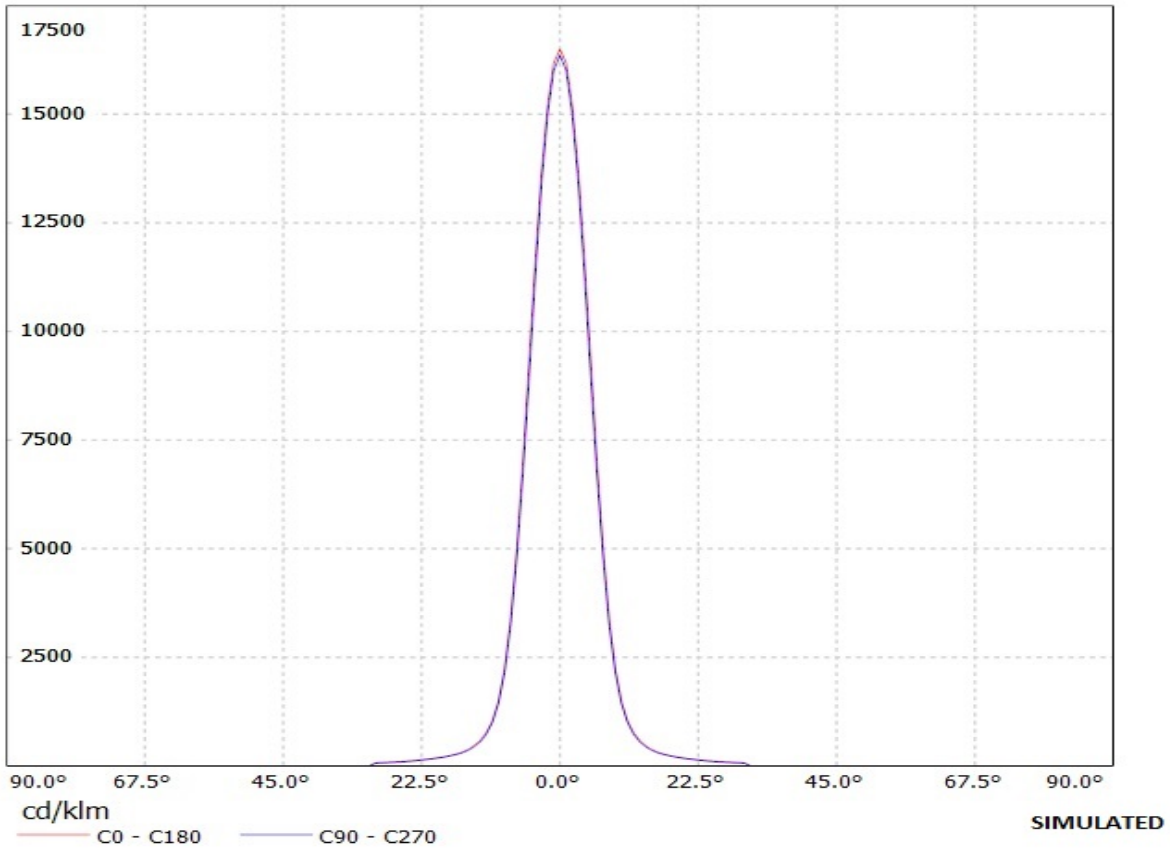

Ledil Oy CA11360_Laura-D-XP-tape CA11360_Laura-D-XP-tape / LDC (Linear)

Luminaire: Ledil Oy CA11360_Laura-D-XP-tape CA11360_Laura-D-XP-tape

Lamps: 1 x Cree XP-E (White)

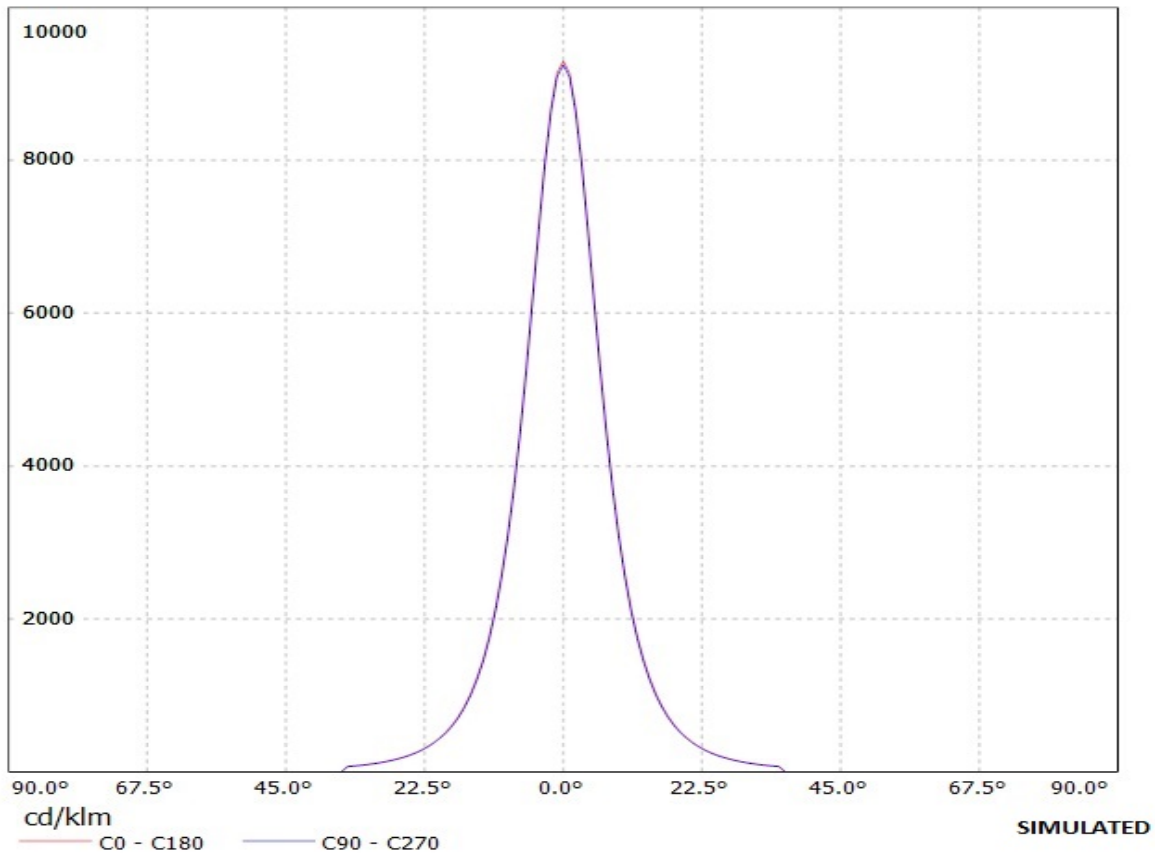

Ledil Oy CA11365-Laura-O-XP-tape CA11365-Laura-O-XP-tape / LDC (Linear)

Luminaire: Ledil Oy CA11365-Laura-O-XP-tape CA11365-Laura-O-XP-tape
Lamps: 1 x Cree XP-E white

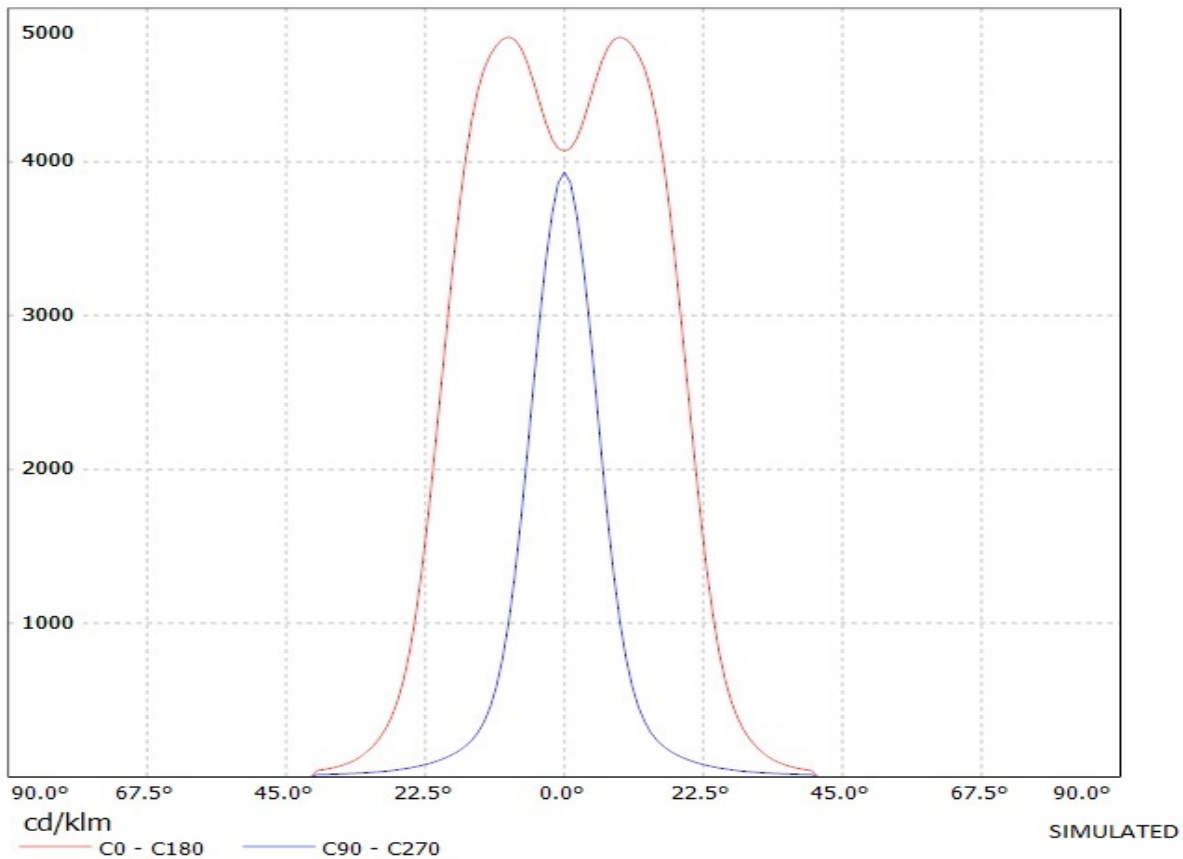

Ledil Oy CA11360_Laura-D-XP-tape CA11360_Laura-D-XP-tape / LDC (Linear)

Luminaire: Ledil Oy CA11360_Laura-D-XP-tape CA11360_Laura-D-XP-tape
Lamps: 1 x Cree XP-E (White)

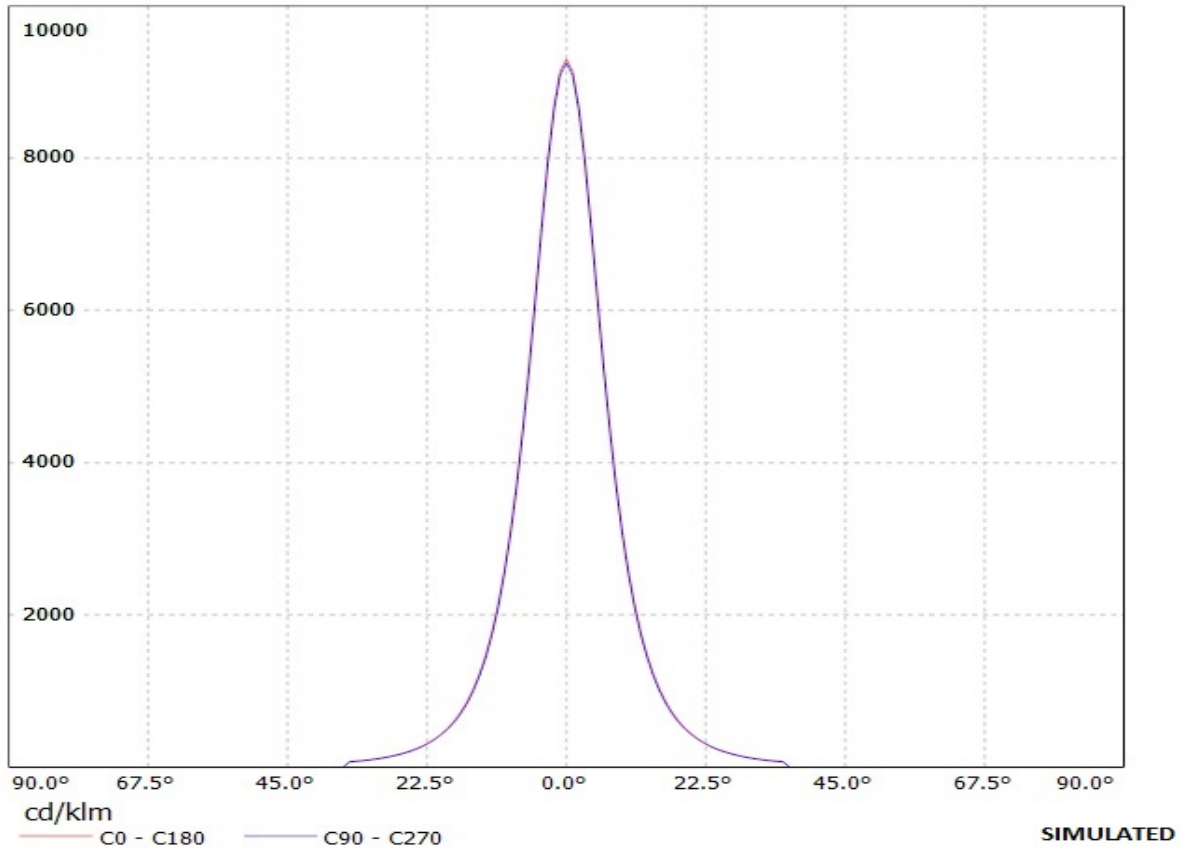

Ledil Oy CA11355_Laura-M-Pin-XP-tape CA11355_Laura-M-Pin-XP-tape LOR=93% / LDC (Linear)

Luminaire: Ledil Oy CA11355_Laura-M-Pin-XP-tape CA11355_Laura-M-Pin-XP-tape LOR=93%
Lamps: 1 x Cree XP-E white

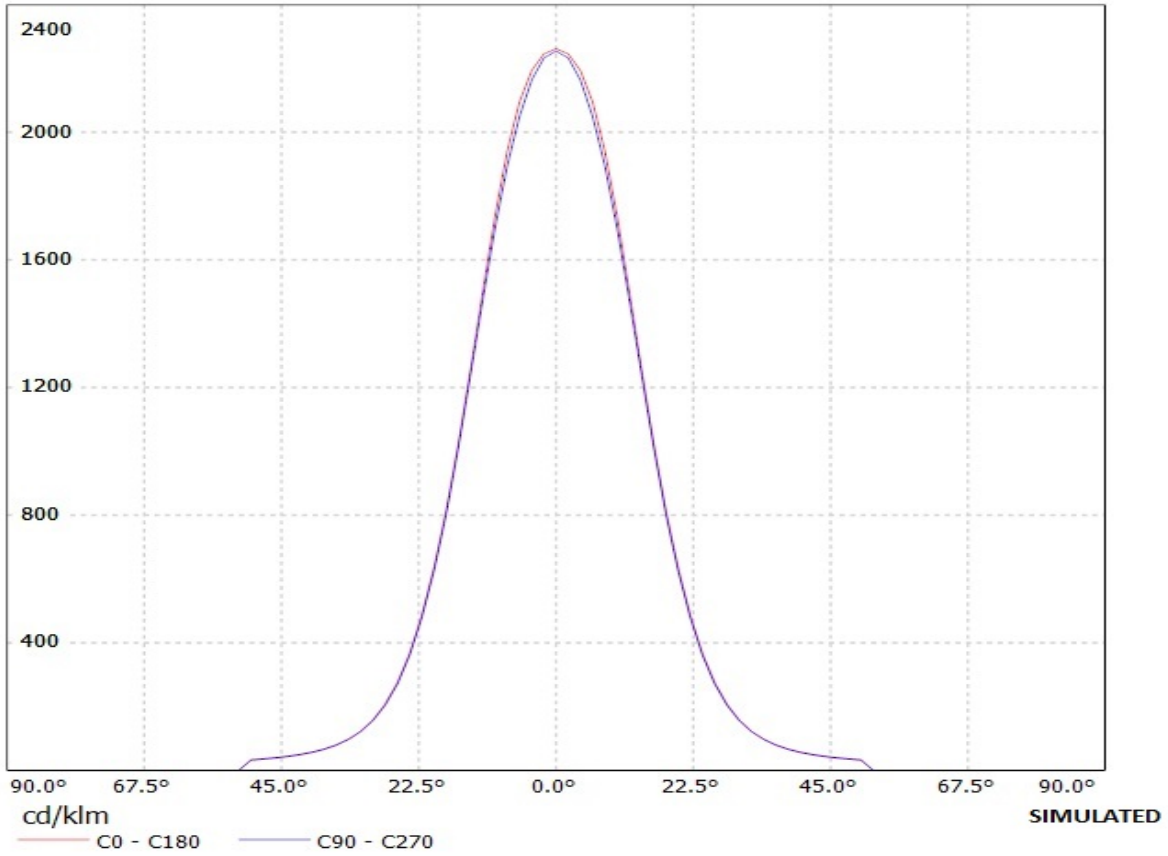

Luminaire: LEDIL OY CA11837_LAURA-M-PIN_(XP-E) Eff.91.8%
Lamps: 1 x XP-E (71.21lm@250mA)

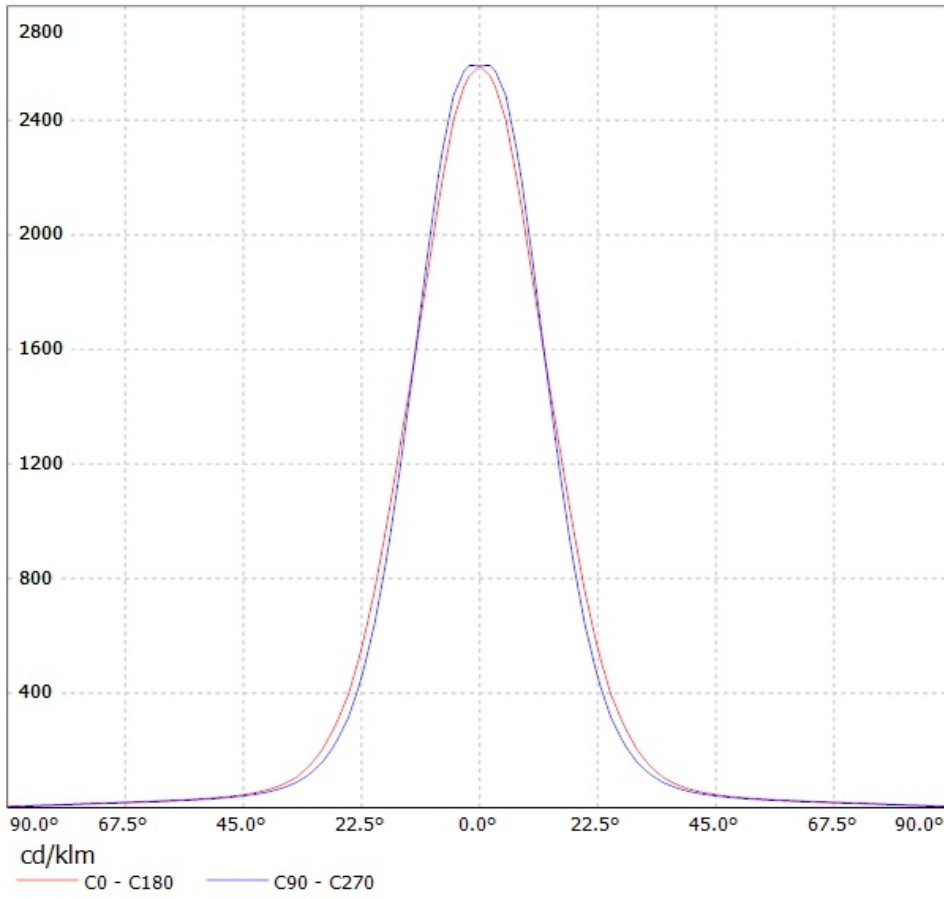

Ledil Oy CA11365-Laura-O-XP-tape CA11365-Laura-O-XP-tape / LDC (Linear)

Luminaire: Ledil Oy CA11365-Laura-O-XP-tape CA11365-Laura-O-XP-tape
Lamps: 1 x Cree XP-E white

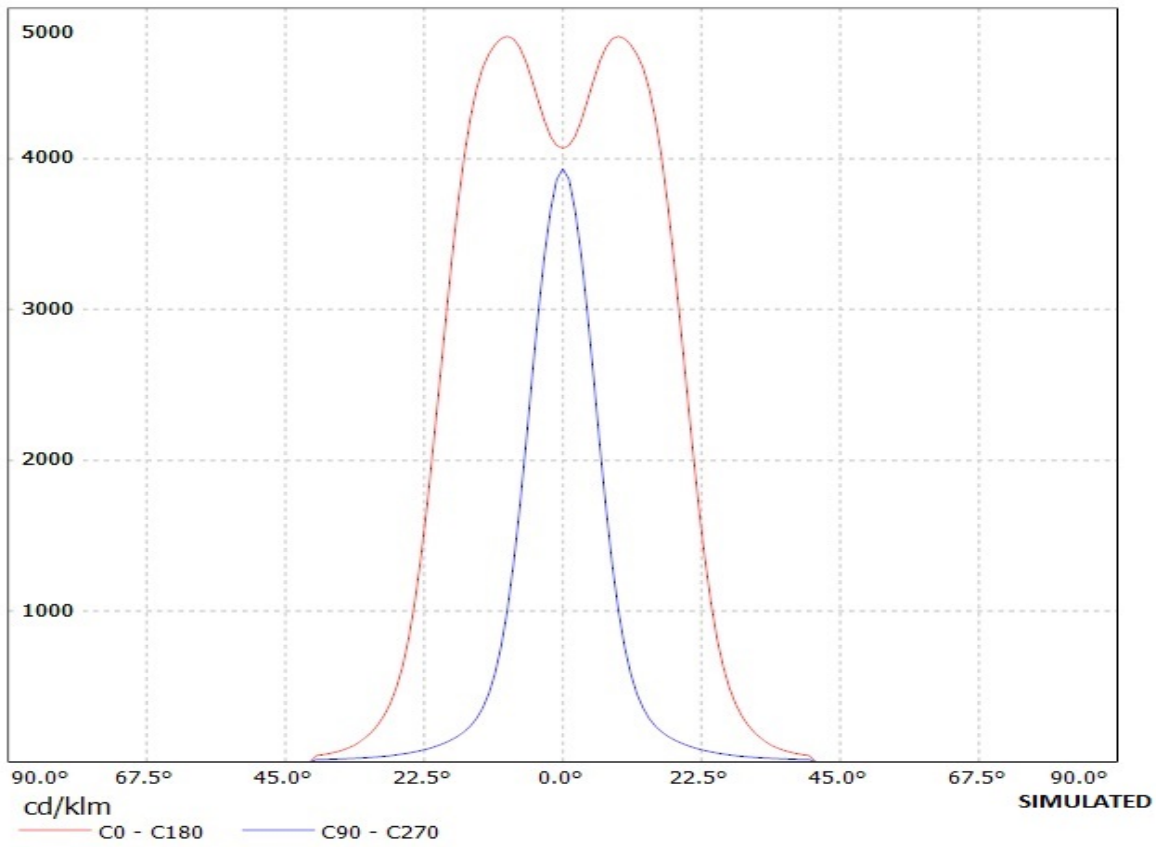

Luminaire: LEDil Oy CA13634_G2-LAURA-W-P_(XP-E)

Lamps: 1 x Cree XP-E (XPEWHT-L1-3C0-Q5-0-06) 78.31lm @ 250mA CCT=5241K P=0.8W I=250mA

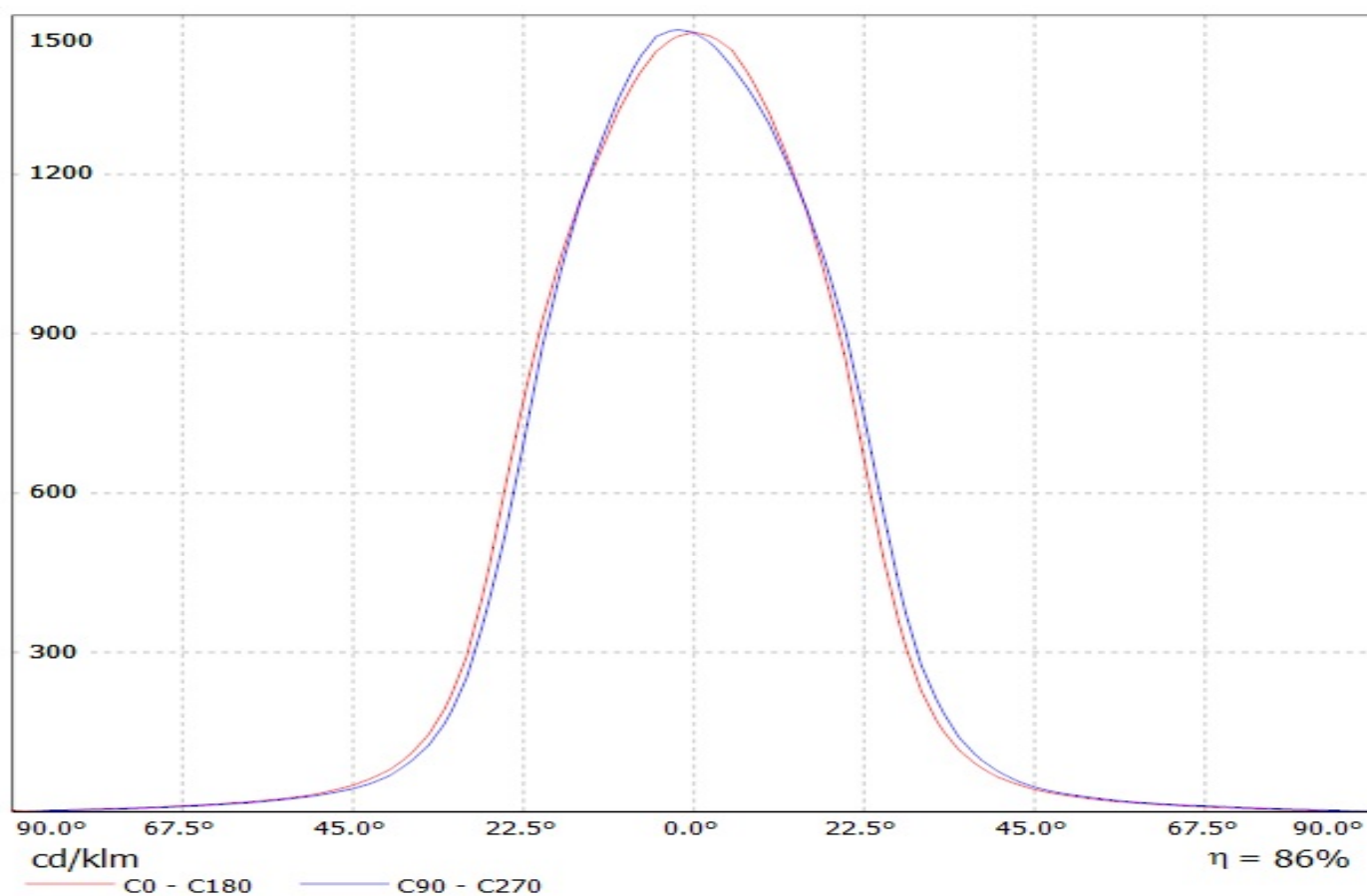

Luminaire: LEDiL CA12344_LAURA-W-PIN_(XP-E) Eff.92%
Lamps: 1 x Cree XP-E (69lm@250mA)

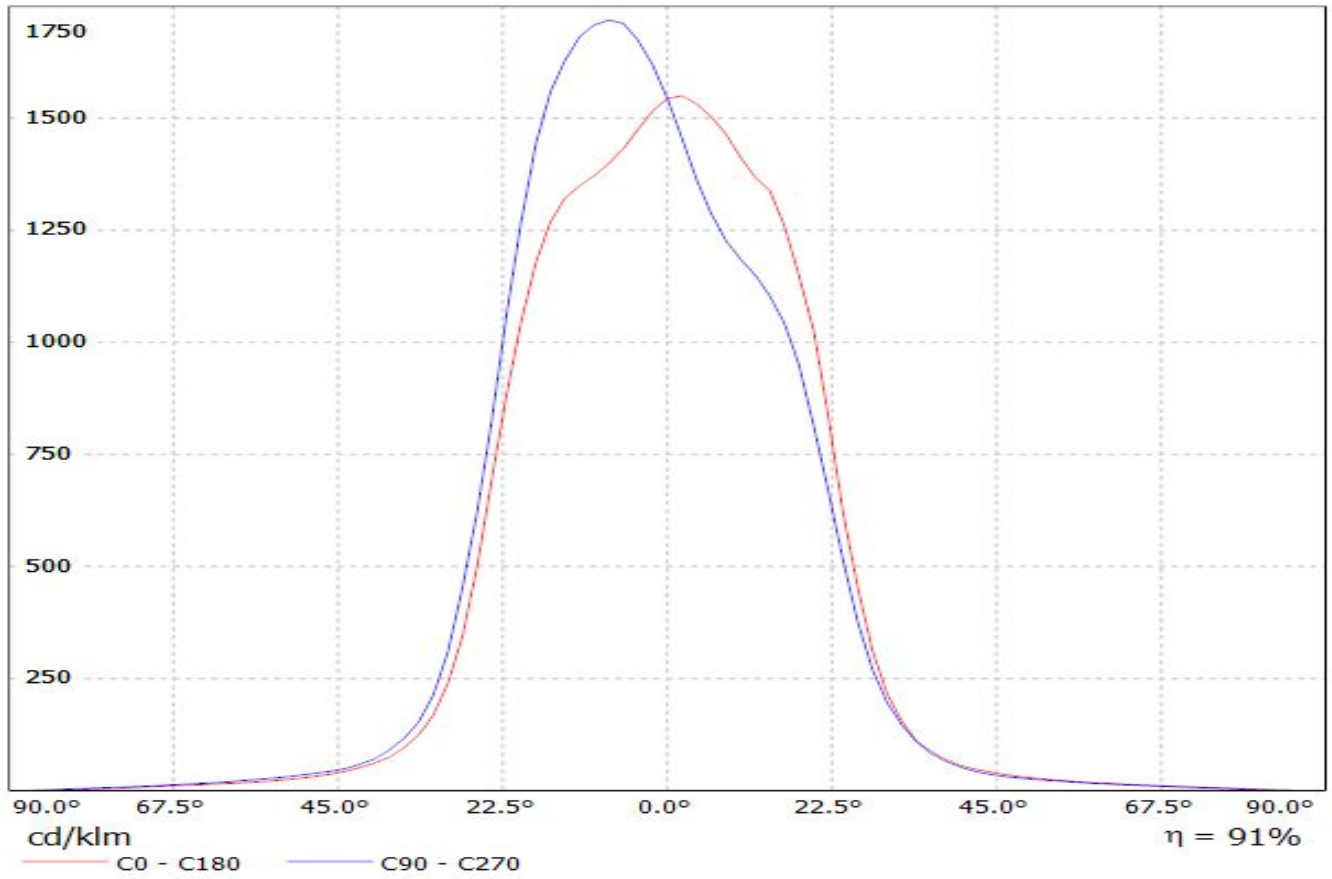

Luminaire: Ledil Oy CA11766_Laura-WW-XP-tape CA11766_Laura-WW-XP-tape
Lamps: 1 x Cree XP-E white

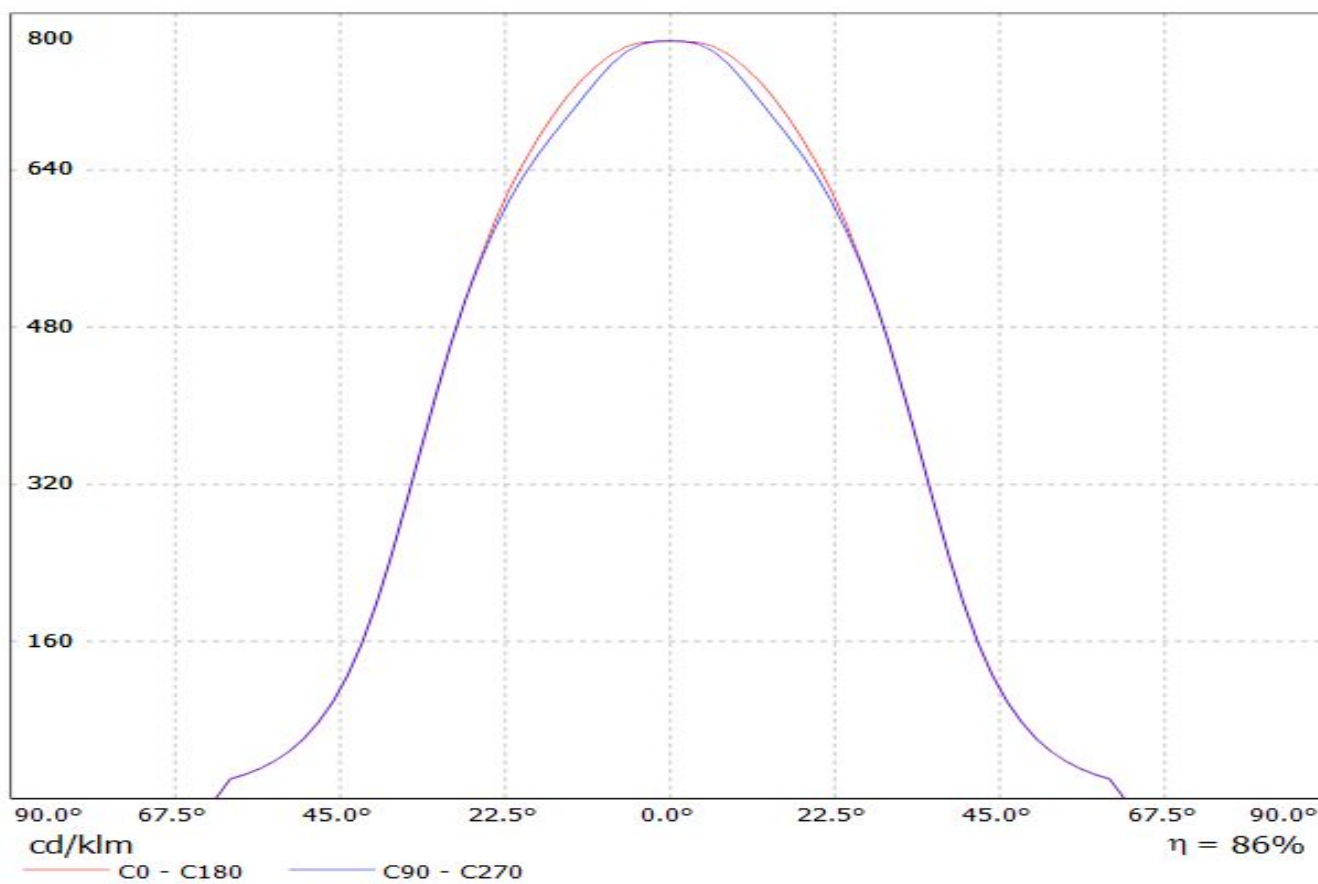

Ledil Oy CA12325_Laura-WW-PIN-WHT CA12325_Laura-WW-PIN-WHT Efficiency=86% / LDC
(Linear)

Luminaire: Ledil Oy CA12325_Laura-WW-PIN-WHT CA12325_Laura-WW-PIN-WHT Efficiency=86%
Lamps: 1 x Cree XP-E white 78lm @ 250mA

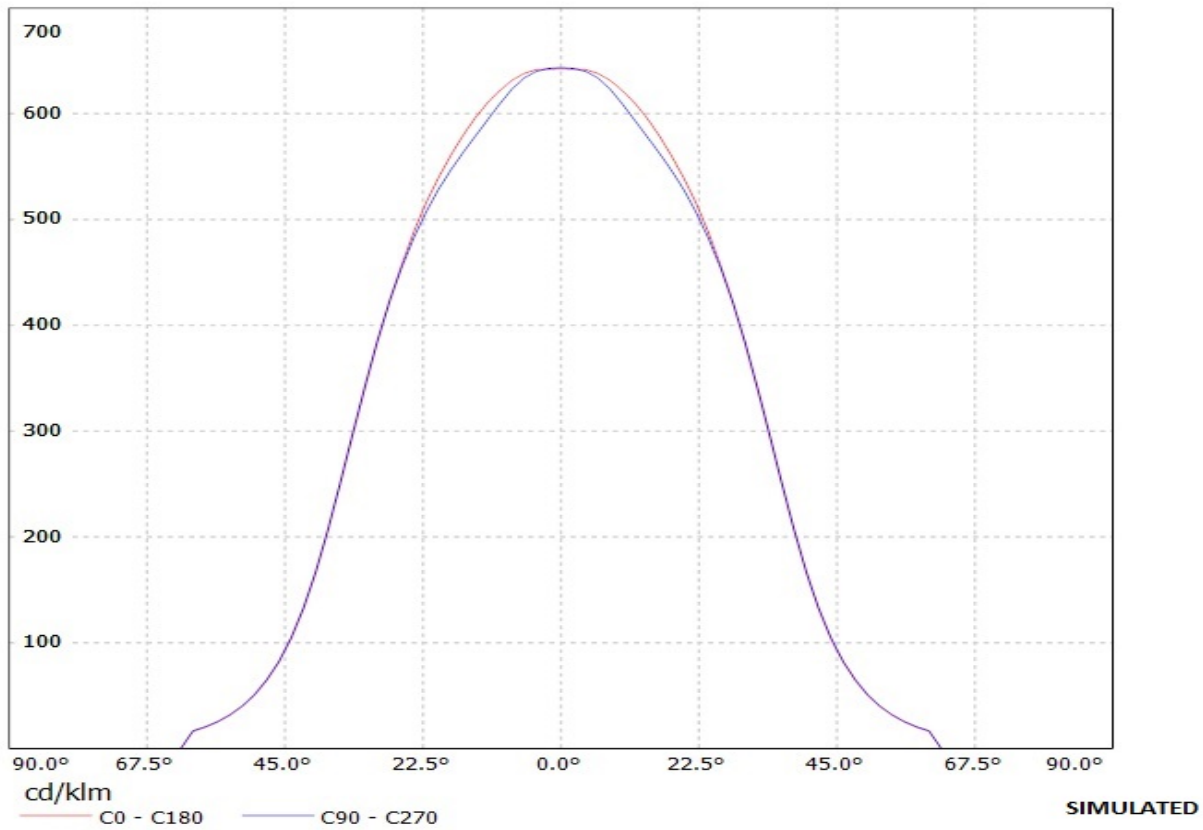

Luminaire: LEDiL Oy CA11525_LAURA-R-W_(XP-E)

Lamps: 1 x Cree_XP-E_(XPEWHT-L1-3C0-Q5-0-06)_76.8195lm@250mA_P=0.792615W_I=0.250A

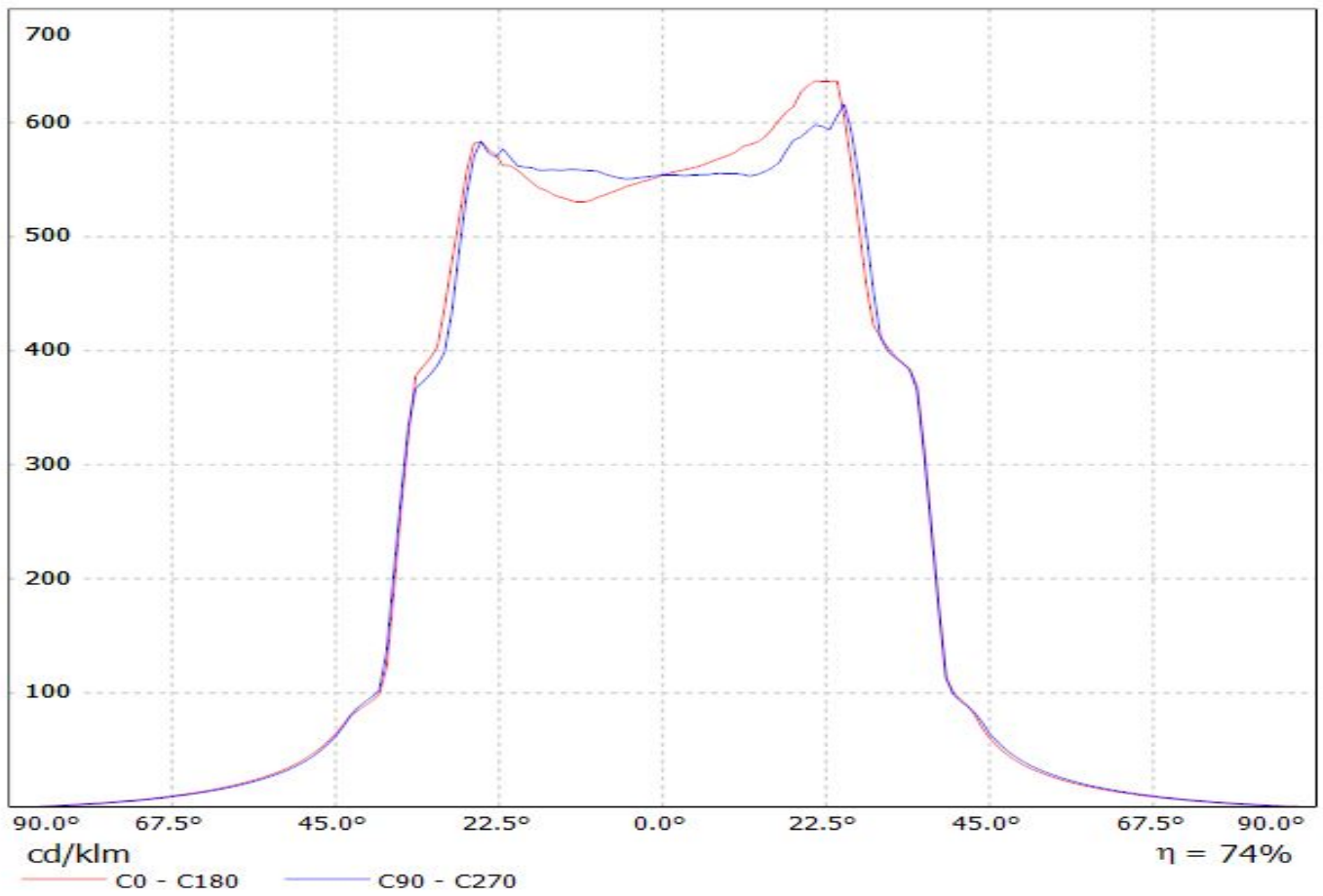

Luminaire: LEDil Oy CA13636_G2-LAURA-R-XW-P_(XP-E)

Lamps: 1 x Cree XP-E (XPEWHT-L1-3C0-Q5-0-06) 78.31lm @ 250mA CCT=5241K P=0.8W I=250mA

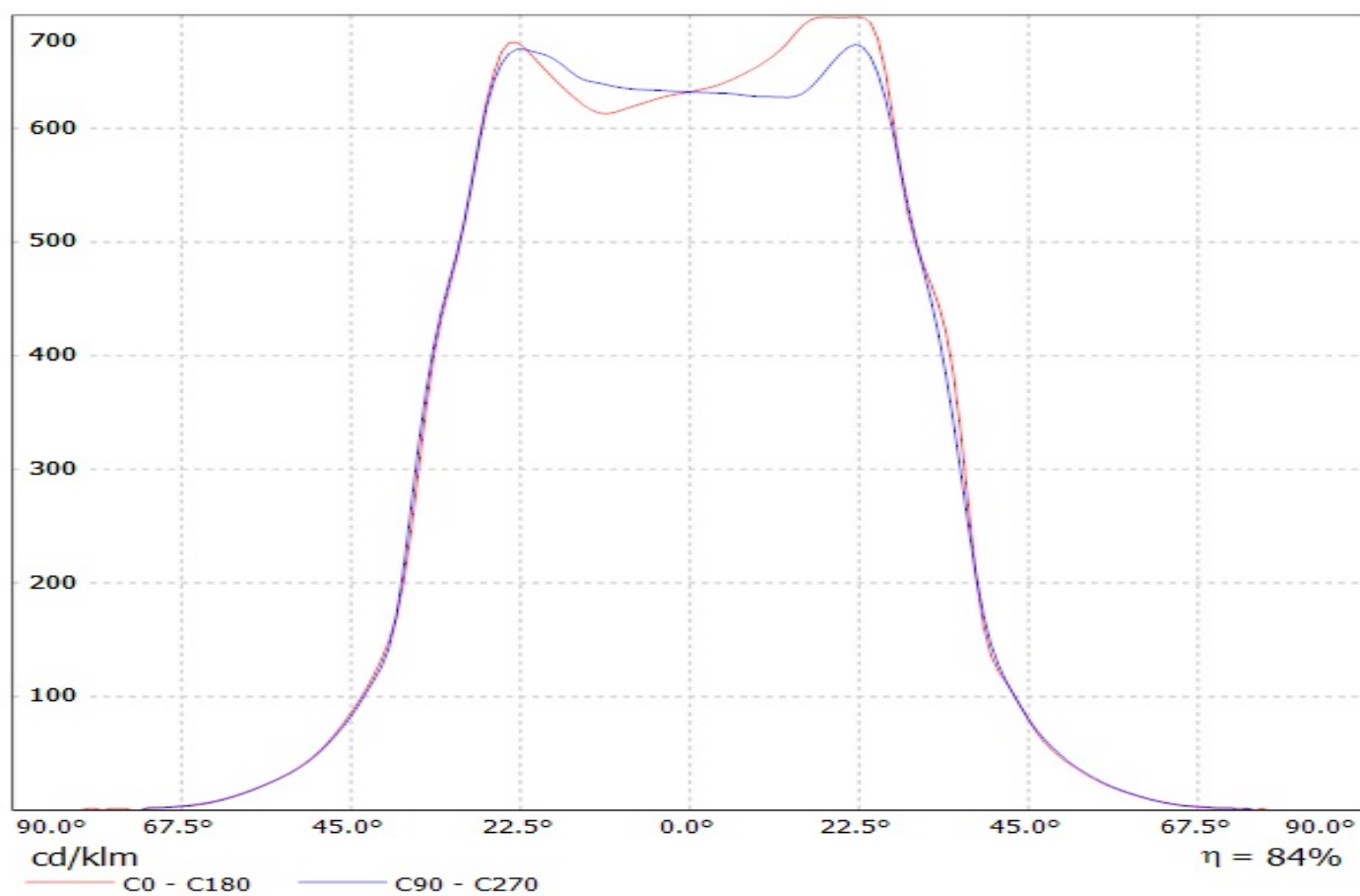

Luminaire: Ledil Oy CA13269_LAURA-SS-WAS_(XP-E) Efficiency=92%
Lamps: 1 x Cree XP-E 70lm @ 250mA

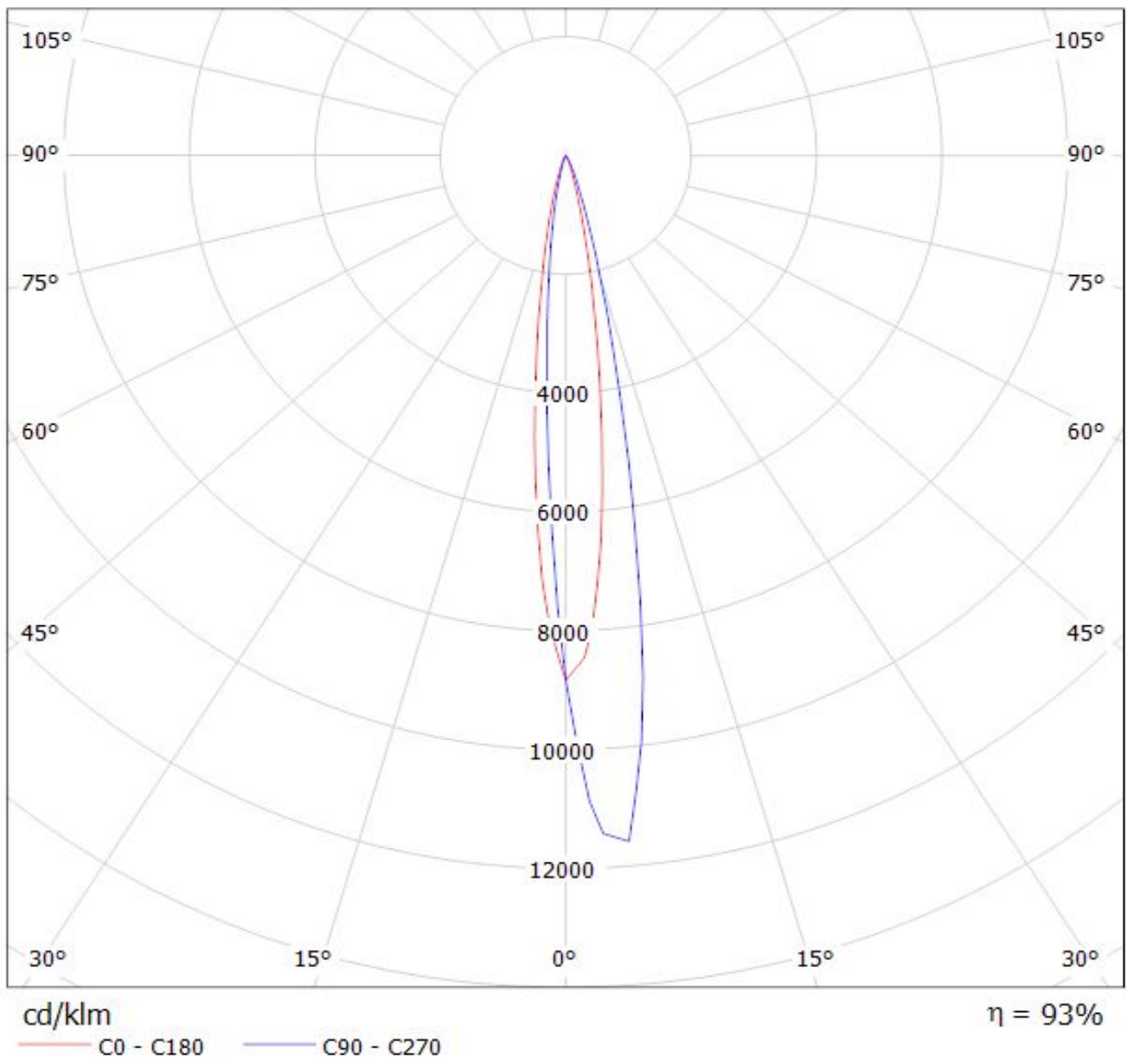

Luminaire: Ledil Oy CA13271_LAURA-O-WAS_(XP-E) Efficiency=84%
Lamps: 1 x Cree XP-E 70lm @ 250mA

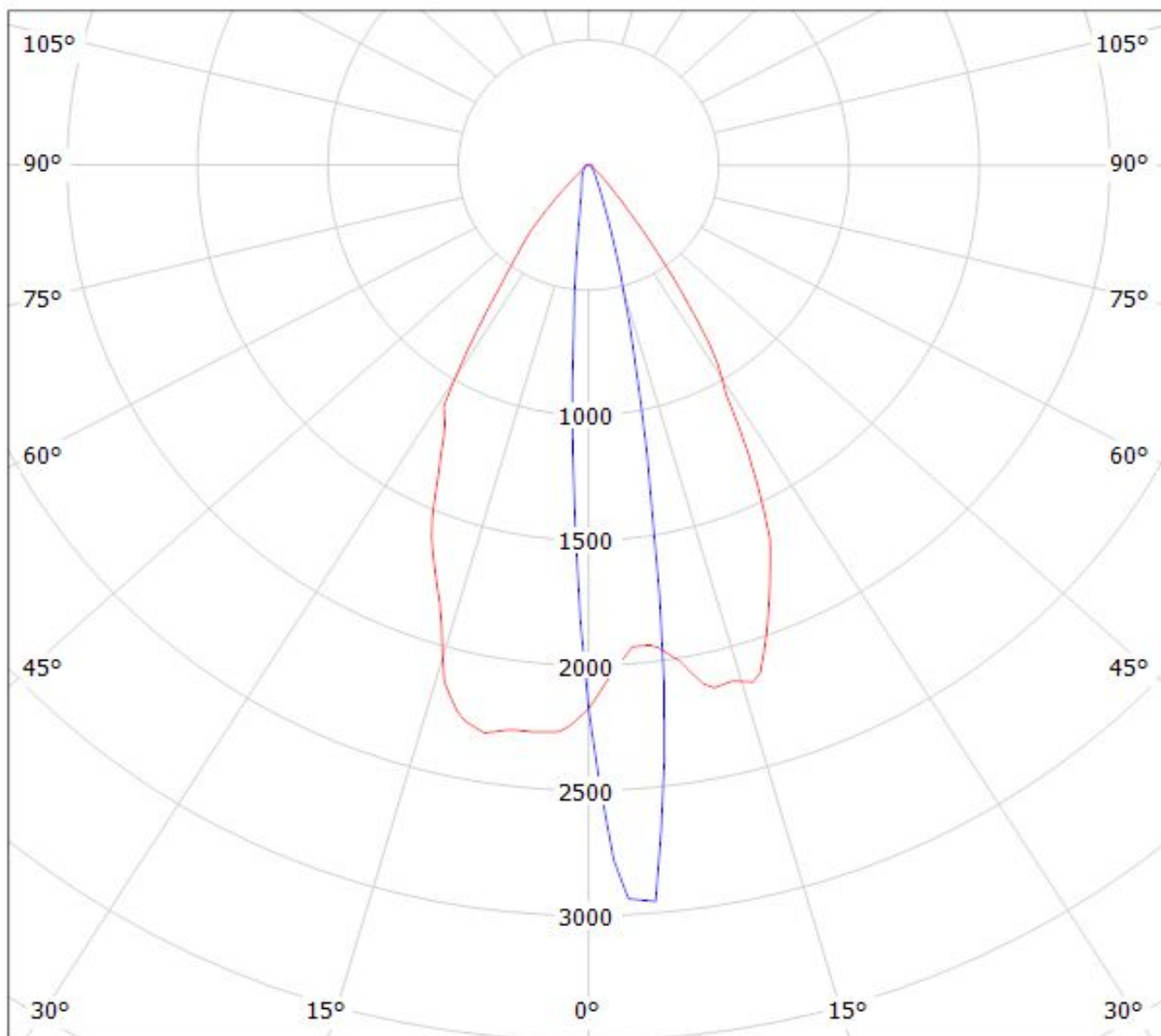

cd/klm

— C0 - C180

— C90 - C270

$\eta = 85\%$

Luminaire: Ledil Oy CP13308&CA13307_LAURA-O-WAS (Cree XP-E 70lm @ 250mA) Efficiency=84%
Lamps: 1 x Cree XP-E 70lm @ 250mA

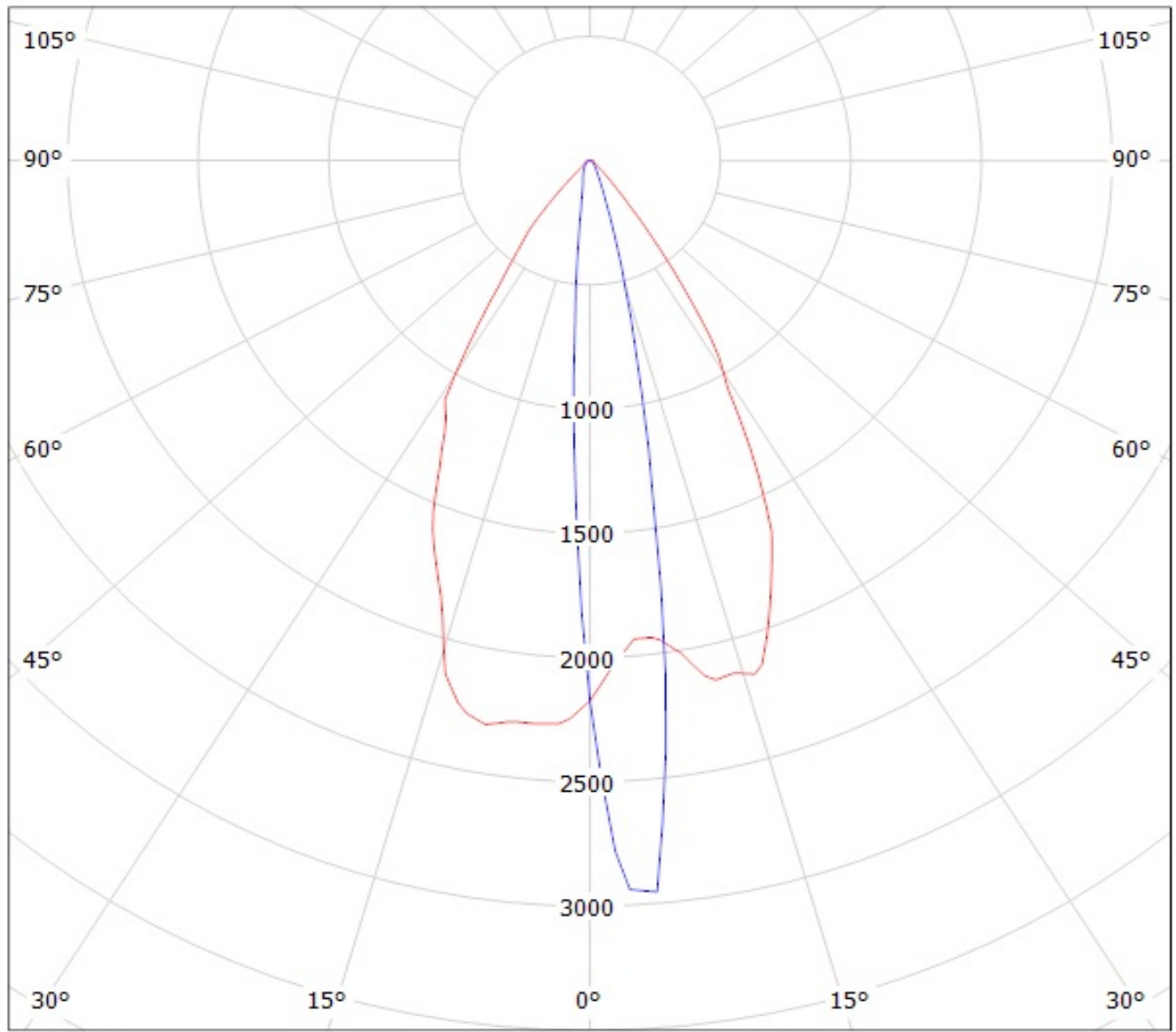

cd/klm
— C0 - C180 — C90 - C270

Luminaire: Ledil Oy CP13308&CA13307_LAURA-O-WAS (Cree XP-E 70lm @ 250mA) Efficiency=84%
Lamps: 1 x Cree XP-E 70lm @ 250mA

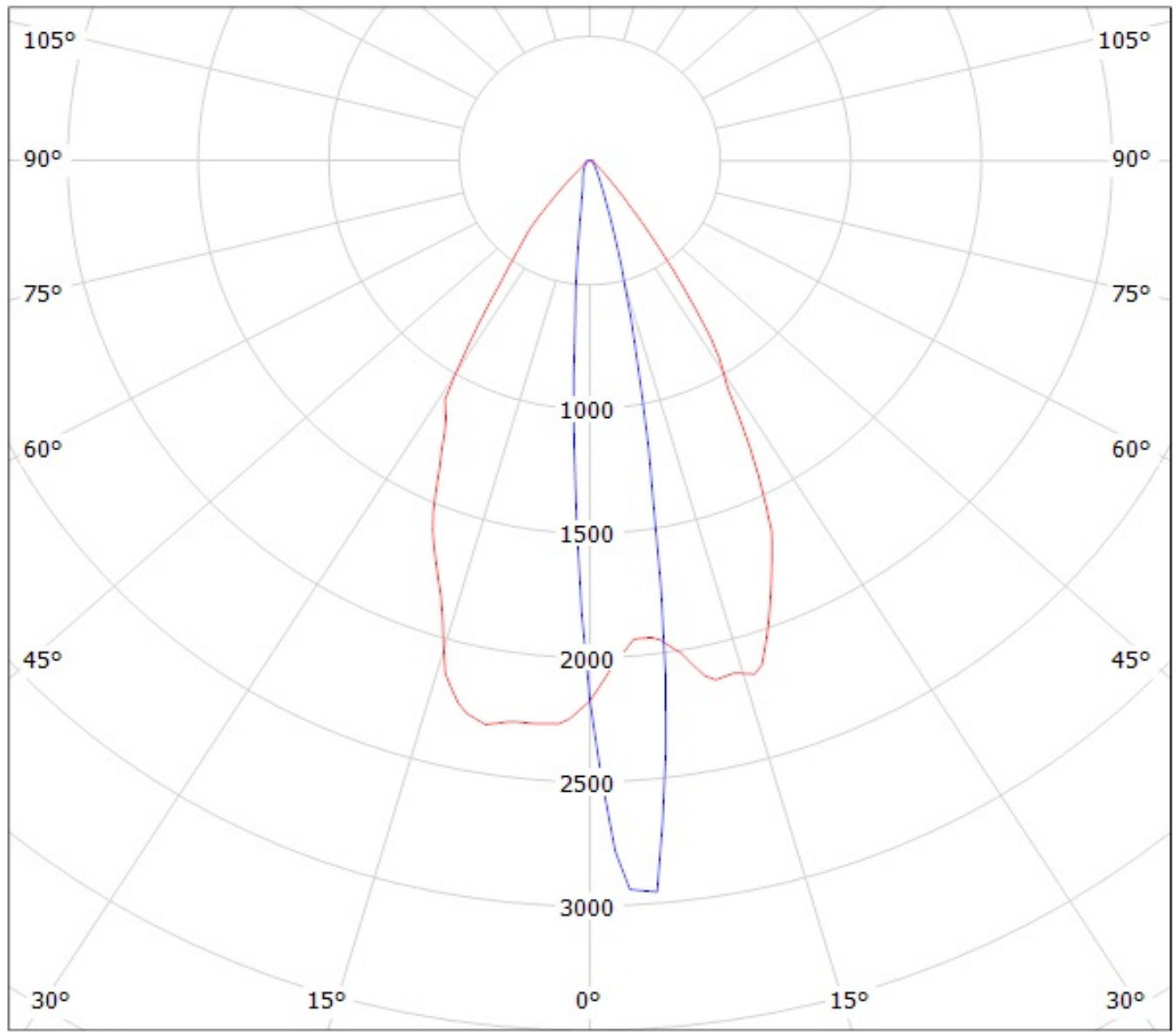

cd/klm
— C0 - C180 — C90 - C270

Luminaire: Ledil Oy CP13311&CA13312_LAURA-SS-WAS (Cree XP-E 70lm @ 250mA) Efficiency=92%
Lamps: 1 x Cree XP-E 70lm @ 250mA

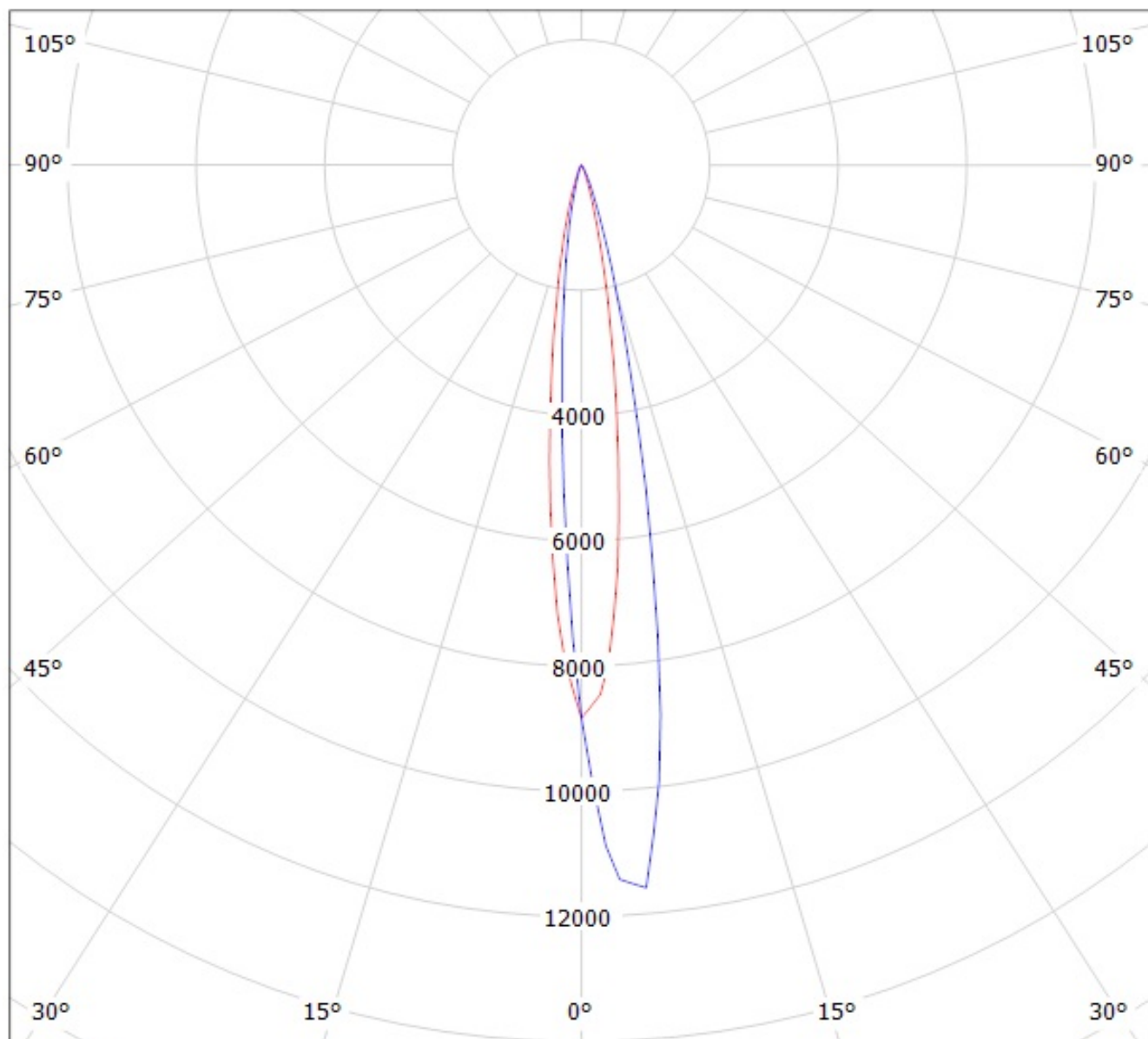

cd/klm

— C0 - C180

— C90 - C270

Luminaire: Ledil Oy CP13311&CA13312_LAURA-SS-WAS (Cree XP-E 70lm @ 250mA) Efficiency=92%
Lamps: 1 x Cree XP-E 70lm @ 250mA

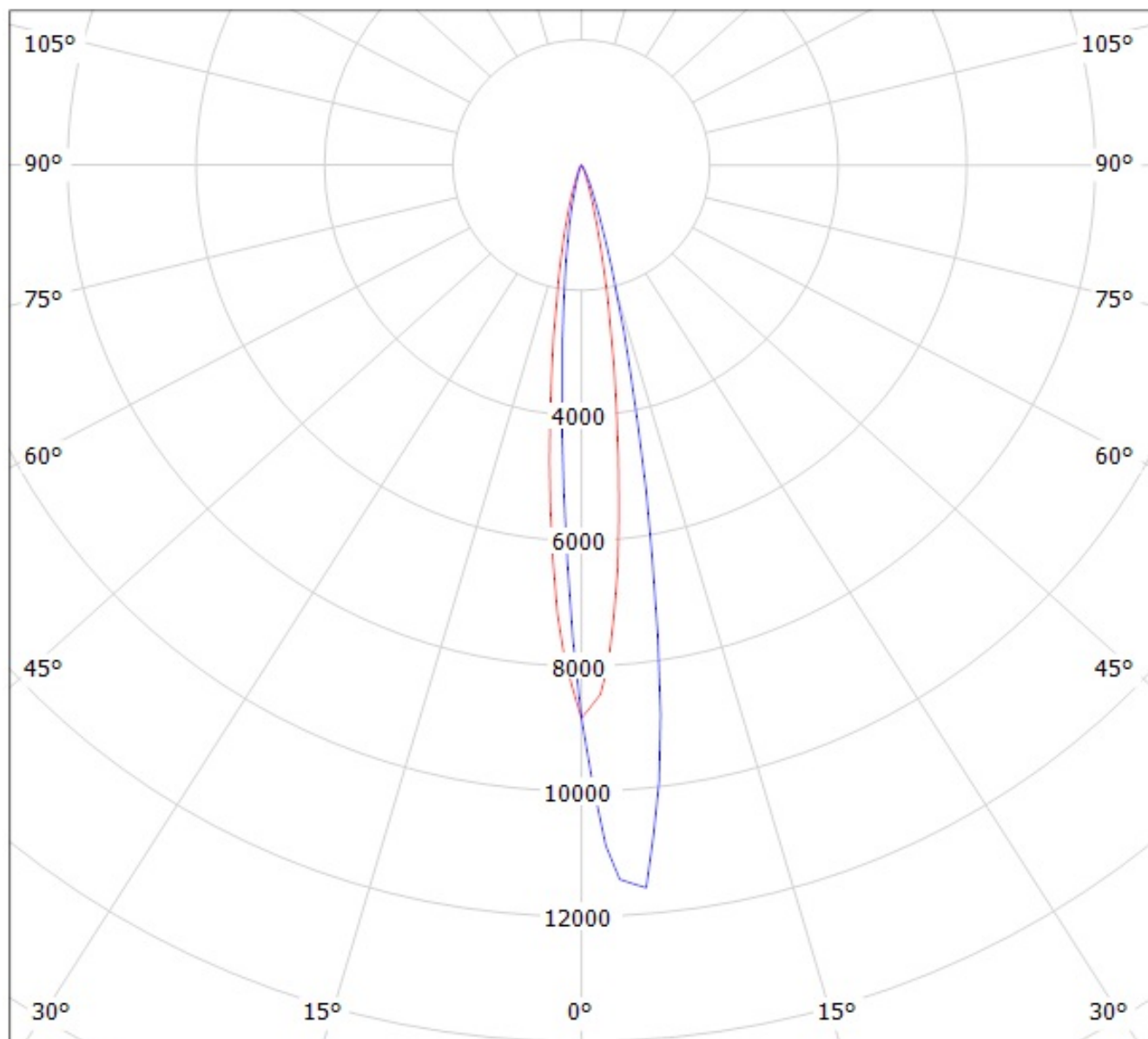

cd/klm

— C0 - C180

— C90 - C270

Ledil Oy CA11353_Laura-RS-XP-tape CA11353_Laura-RS-XP-tape / LDC (Polar)

Luminaire: Ledil Oy CA11353_Laura-RS-XP-tape CA11353_Laura-RS-XP-tape

Lamps: 1 x Cree XP-E (White)

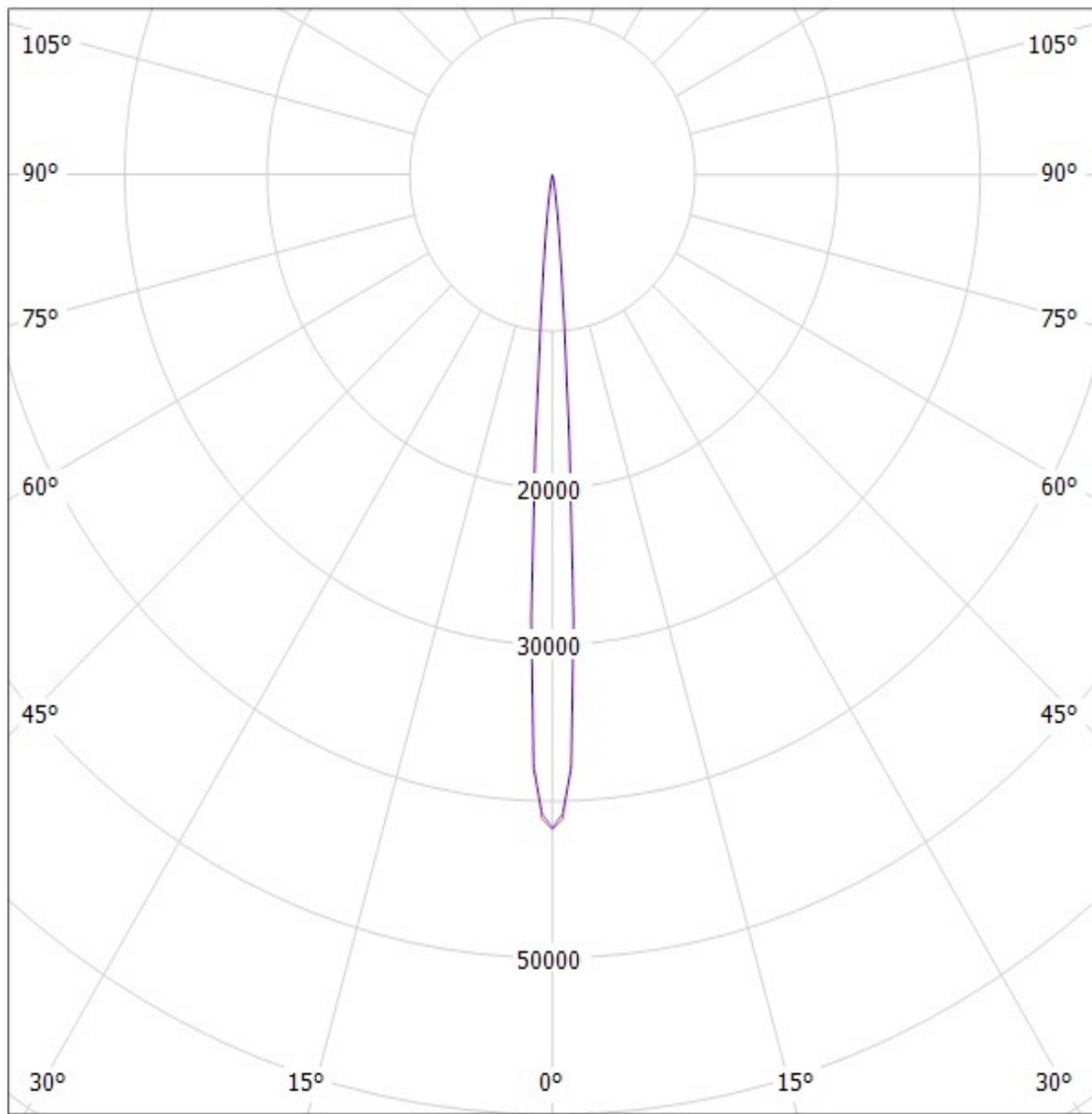

cd/klm

— C0 - C180

— C90 - C270

SIMULATED

Ledil Laura-RS-Pin-XP Laura-RS-Pin-XP / LDC (Polar)

Luminaire: Ledil Laura-RS-Pin-XP Laura-RS-Pin-XP
Lamps: 1 x LED Module

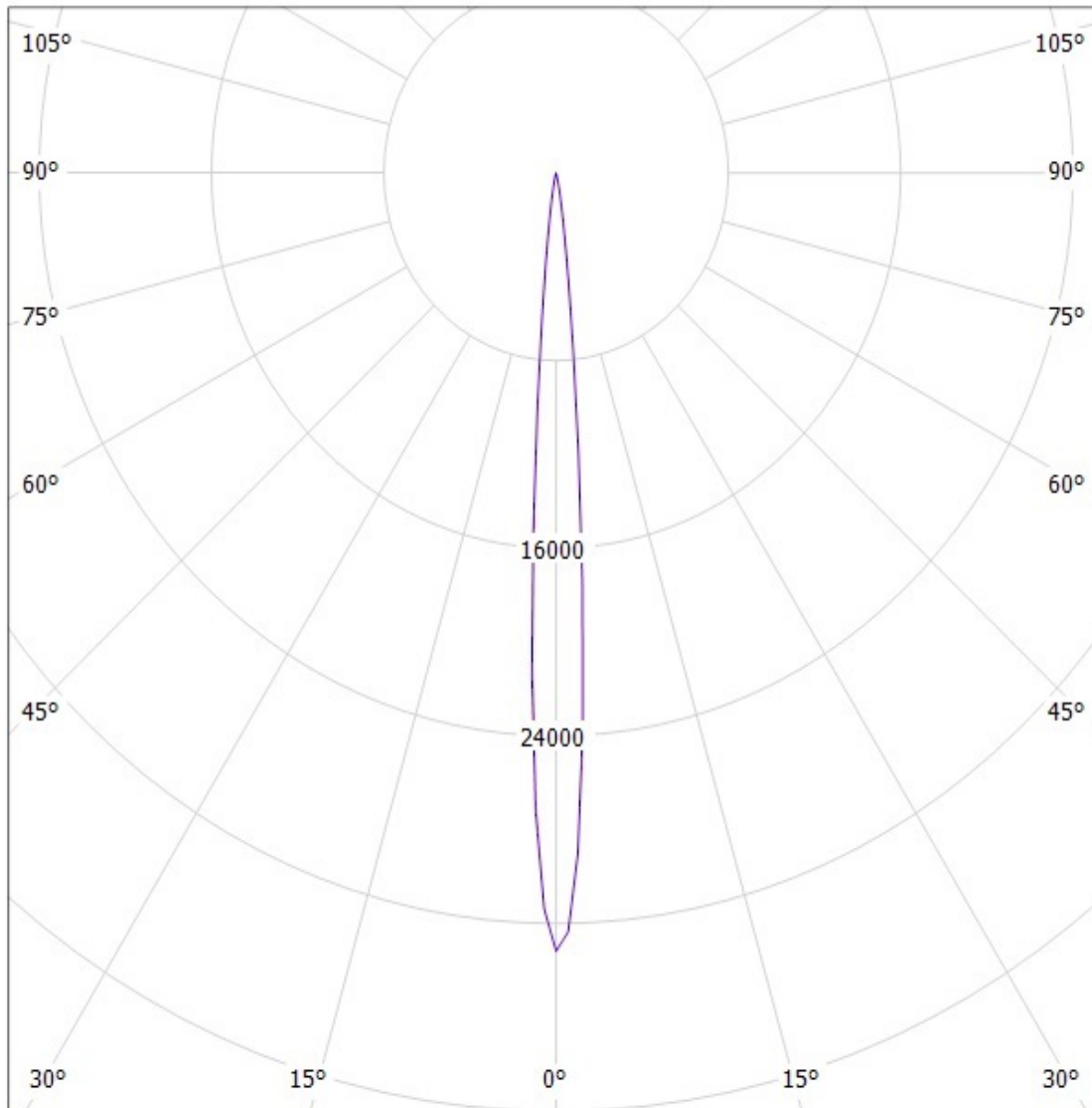

cd/klm

— C0 - C180 — C90 - C270

SIMULATED

Ledil Oy CA11643_Laura-SS-XP CA11643_Laura-SS-XP / LDC (Polar)

Luminaire: Ledil Oy CA11643_Laura-SS-XP CA11643_Laura-SS-XP
Lamps: 1 x Cree XP-E(white)

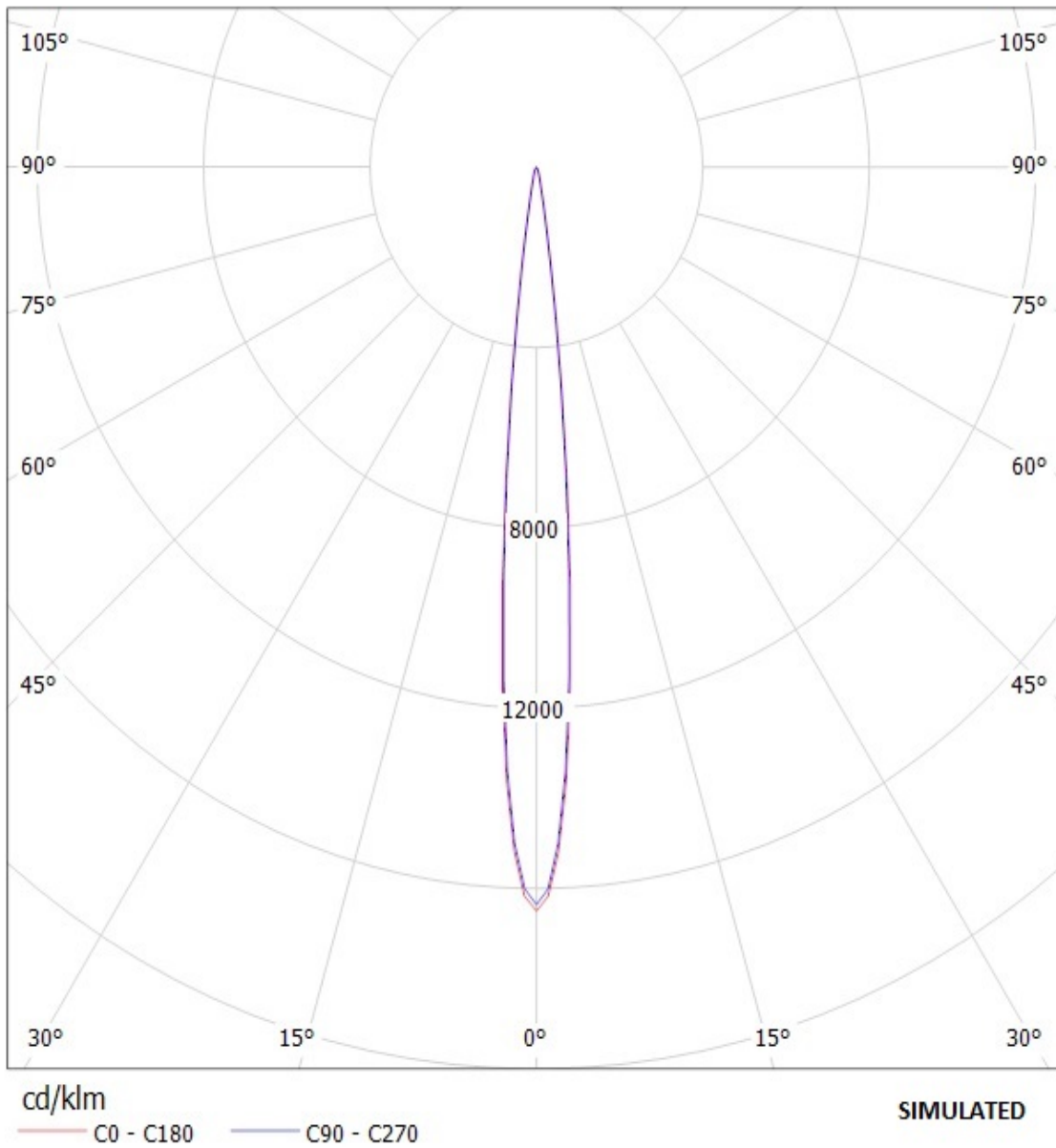

Ledil Oy CA11360_Laura-D-XP-tape CA11360_Laura-D-XP-tape / LDC (Polar)

Luminaire: Ledil Oy CA11360_Laura-D-XP-tape CA11360_Laura-D-XP-tape
Lamps: 1 x Cree XP-E (White)

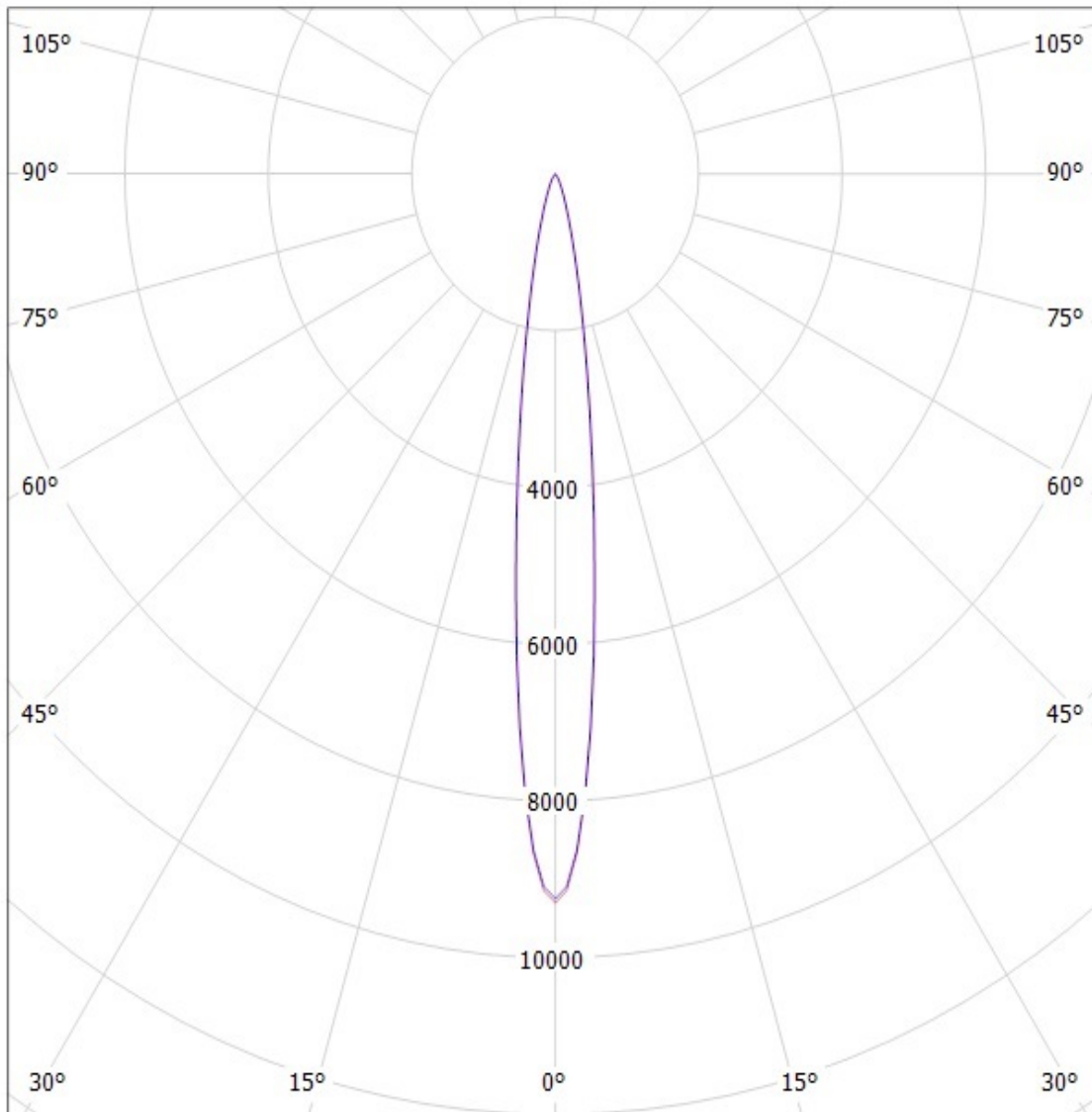

cd/klm

— C0 - C180 — C90 - C270

SIMULATED

Ledil Oy CA11365-Laura-O-XP-tape CA11365-Laura-O-XP-tape / LDC (Polar)

Luminaire: Ledil Oy CA11365-Laura-O-XP-tape CA11365-Laura-O-XP-tape

Lamps: 1 x Cree XP-E white

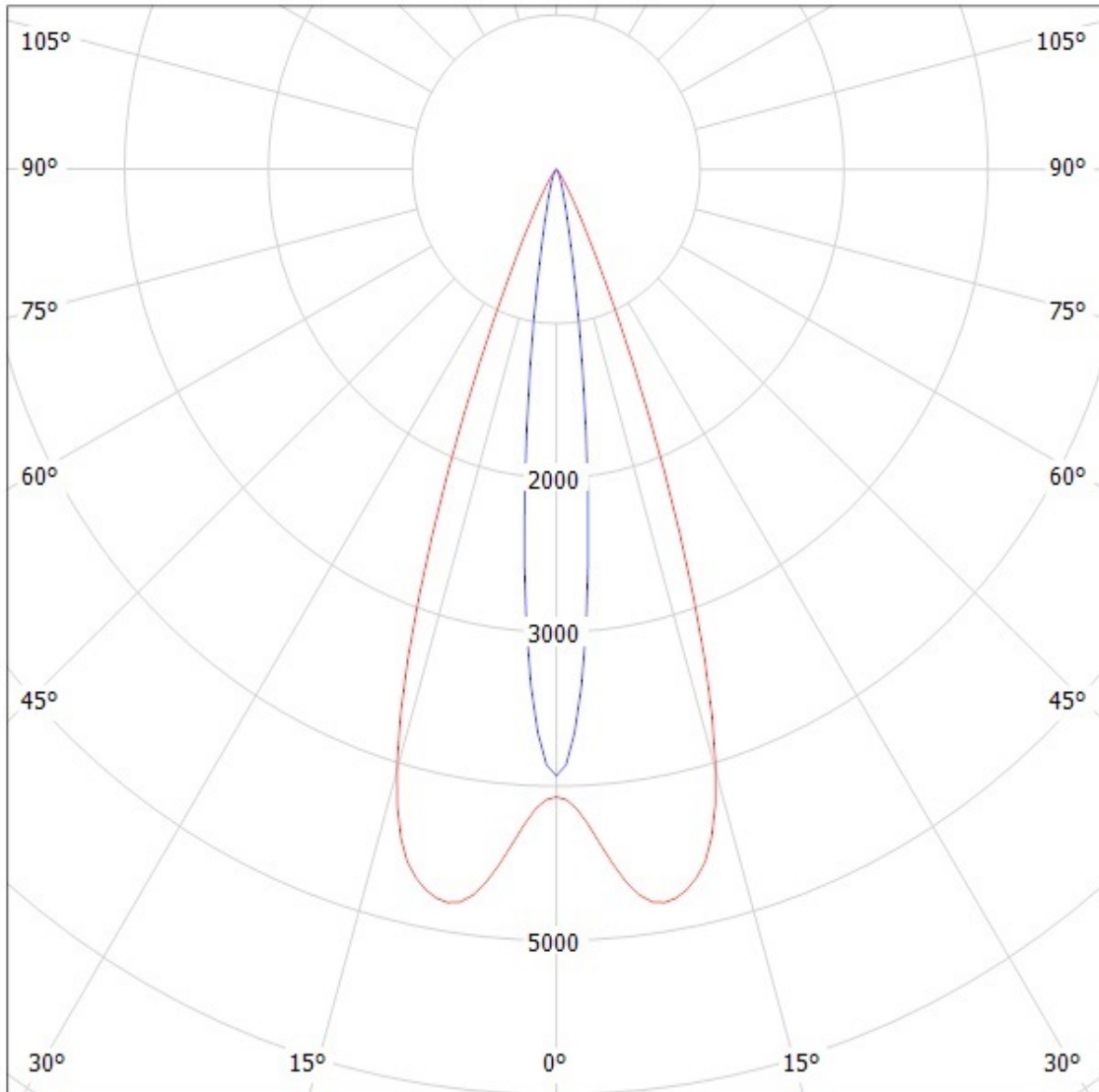

cd/klm

— C0 - C180

— C90 - C270

SIMULATED

Ledil Oy CA11360_Laura-D-XP-tape CA11360_Laura-D-XP-tape / LDC (Polar)

Luminaire: Ledil Oy CA11360_Laura-D-XP-tape CA11360_Laura-D-XP-tape
Lamps: 1 x Cree XP-E (White)

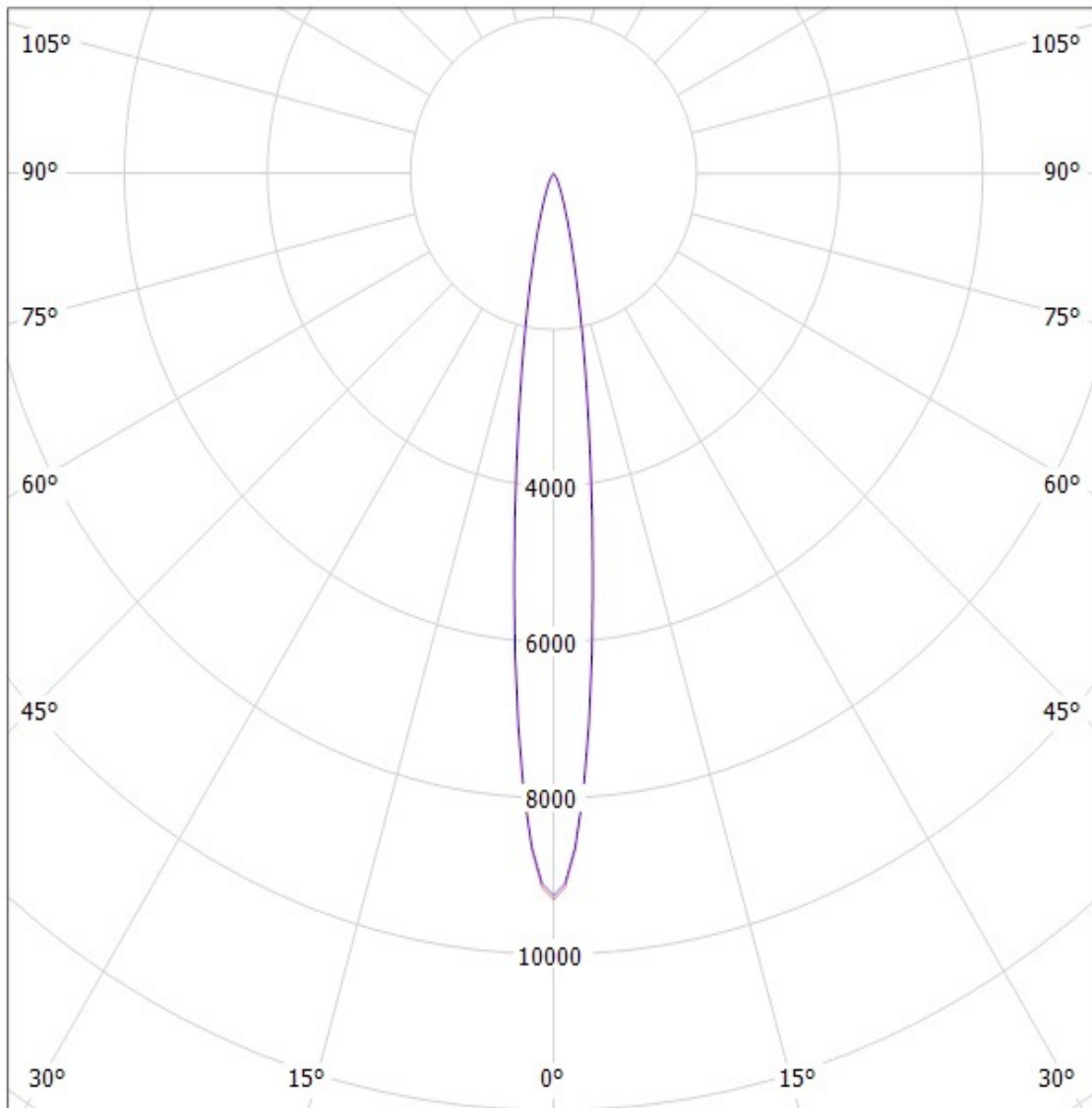

cd/klm

— C0 - C180 — C90 - C270

SIMULATED

Ledil Oy CA11355_Laura-M-Pin-XP-tape CA11355_Laura-M-Pin-XP-tape LOR=93% / LDC (Polar)

Luminaire: Ledil Oy CA11355_Laura-M-Pin-XP-tape CA11355_Laura-M-Pin-XP-tape LOR=93%
Lamps: 1 x Cree XP-E white

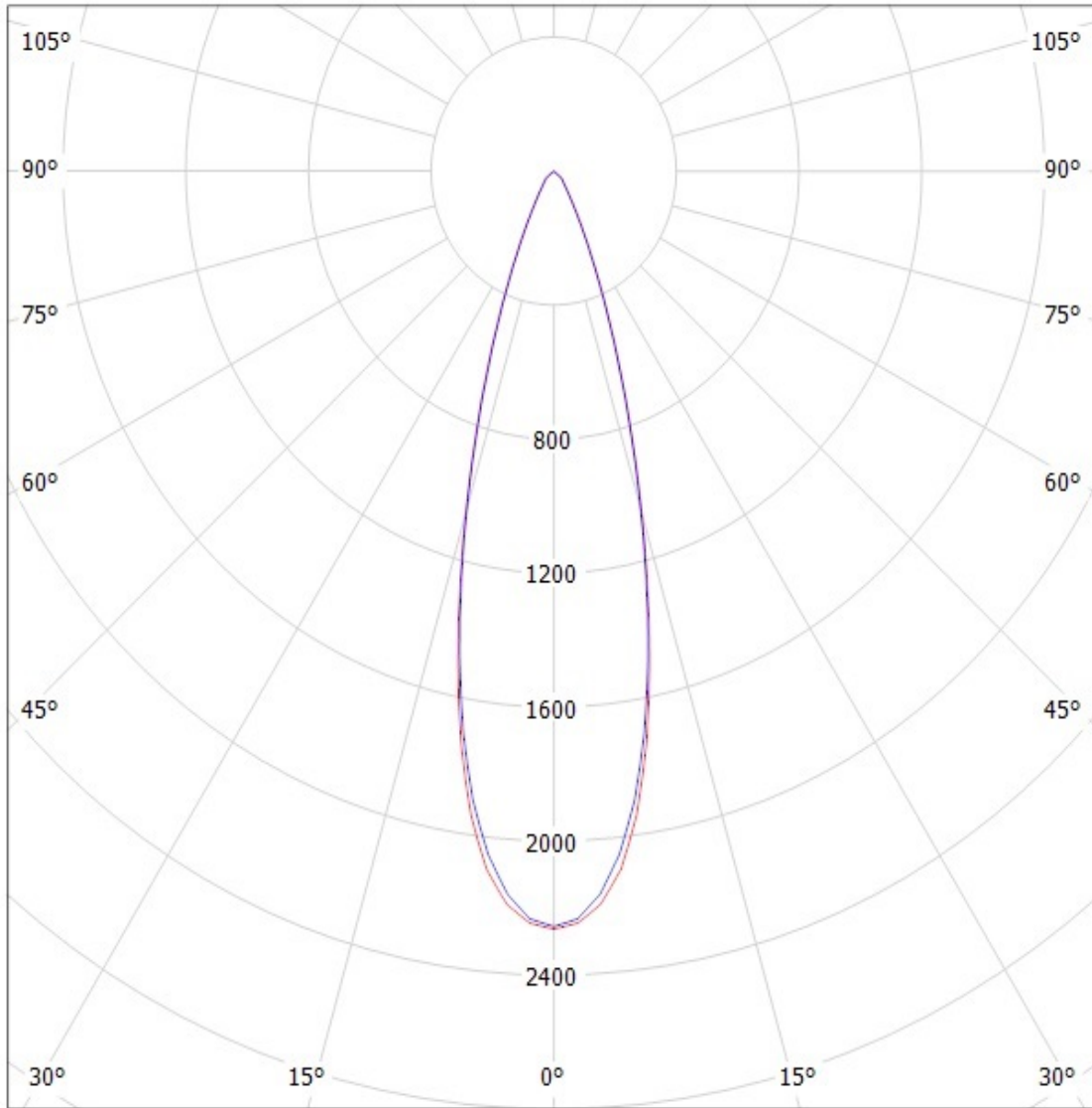

cd/klm

— C0 - C180 — C90 - C270

SIMULATED

Luminaire: LEDIL OY CA11837_LAURA-M-PIN_(XP-E) Eff.91.8%
Lamps: 1 x XP-E (71.21lm@250mA)

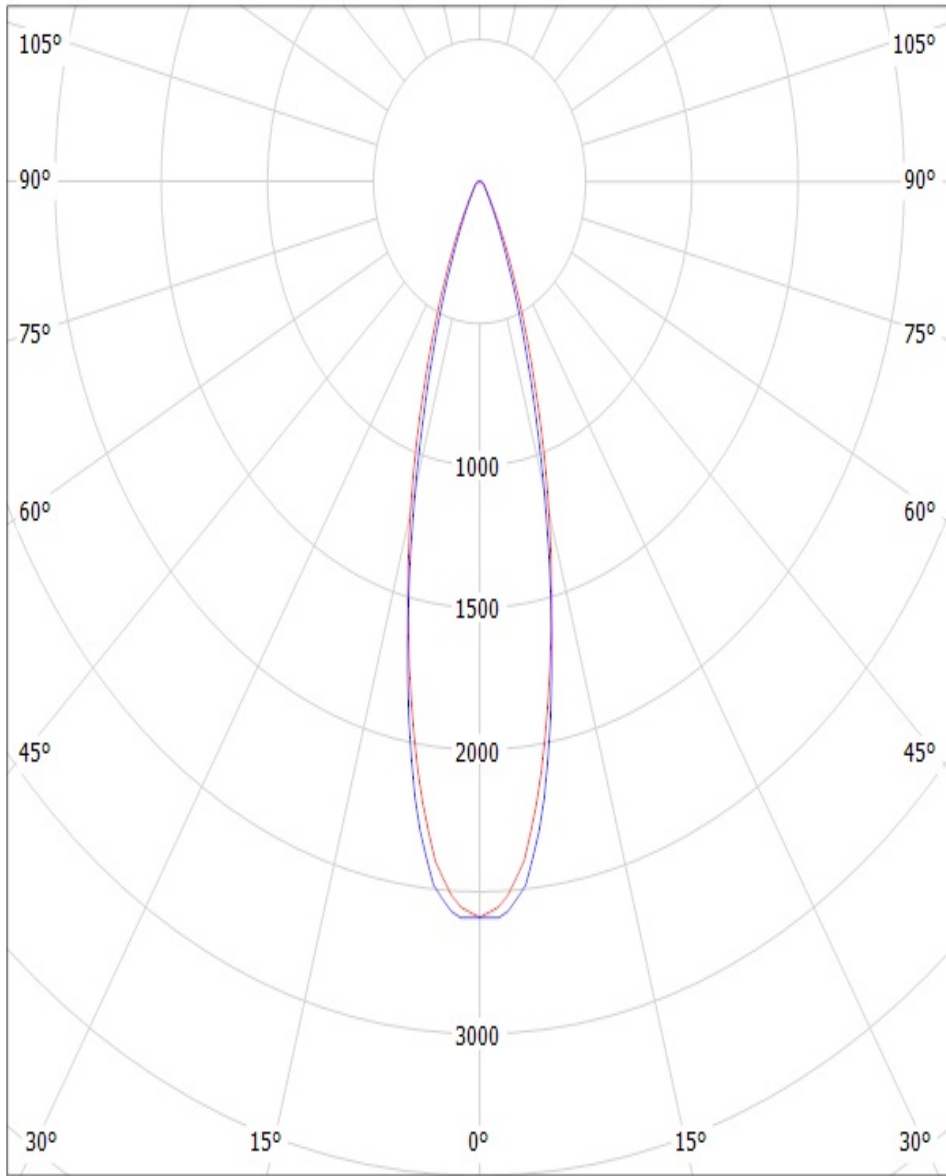

cd/klm

— C0 - C180 — C90 - C270

Ledil Oy CA11365-Laura-O-XP-tape CA11365-Laura-O-XP-tape / LDC (Polar)

Luminaire: Ledil Oy CA11365-Laura-O-XP-tape CA11365-Laura-O-XP-tape

Lamps: 1 x Cree XP-E white

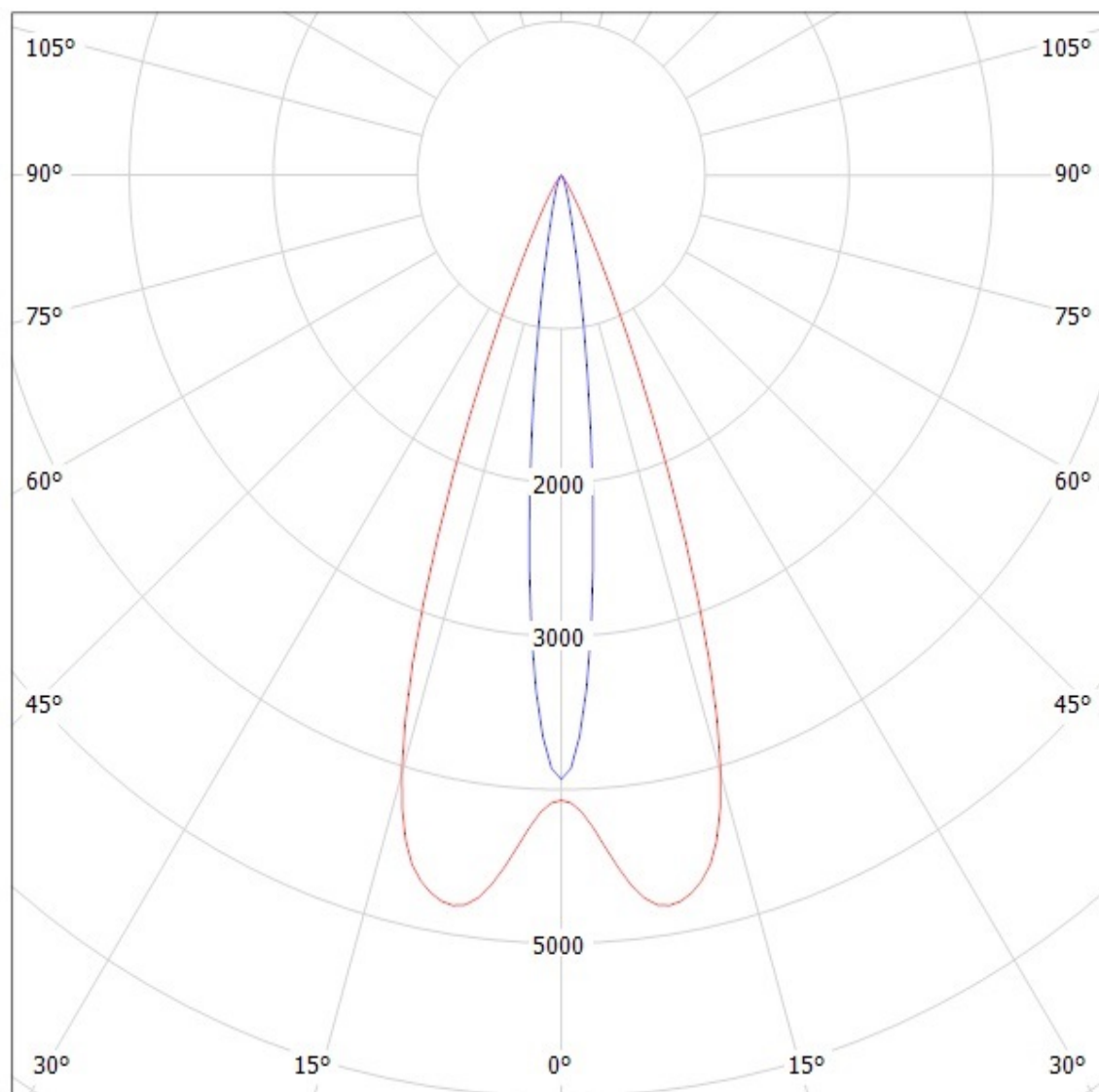

cd/klm

— C0 - C180

— C90 - C270

SIMULATED

Luminaire: LEDil Oy CA13634_G2-LAURA-W-P_(XP-E)

Lamps: 1 x Cree XP-E (XPEWHT-L1-3C0-Q5-0-06) 78.31lm @ 250mA CCT=5241K P=0.8W I=250mA

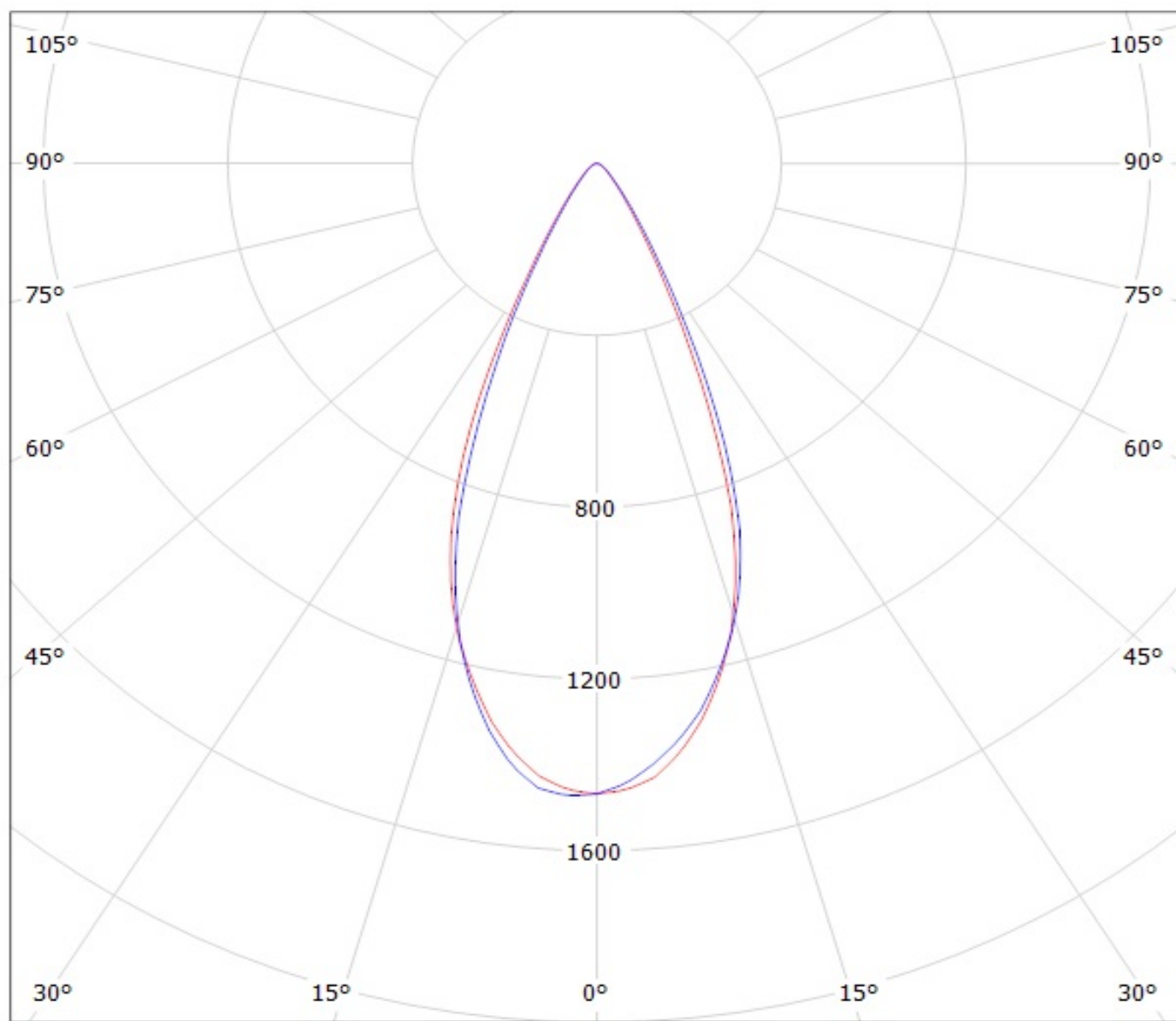

cd/klm

$\eta = 86\%$

— C0 - C180

— C90 - C270

Luminaire: LEDiL CA12344_LAURA-W-PIN_(XP-E) Eff.92%
Lamps: 1 x Cree XP-E (69lm@250mA)

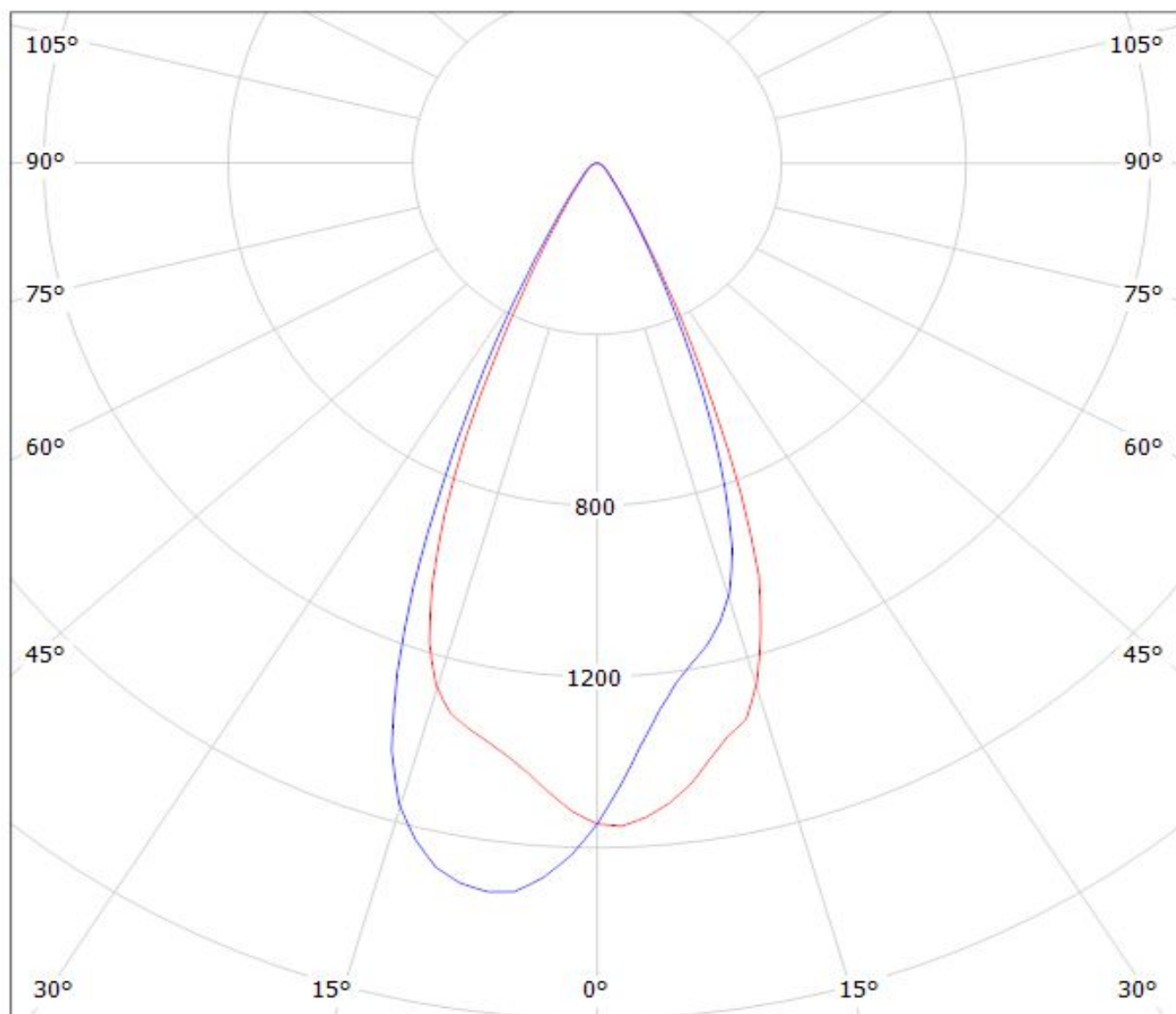

cd/klm

$\eta = 91\%$

— C0 - C180 — C90 - C270

Luminaire: Ledil Oy CA11766_Laura-WW-XP-tape CA11766_Laura-WW-XP-tape
Lamps: 1 x Cree XP-E white

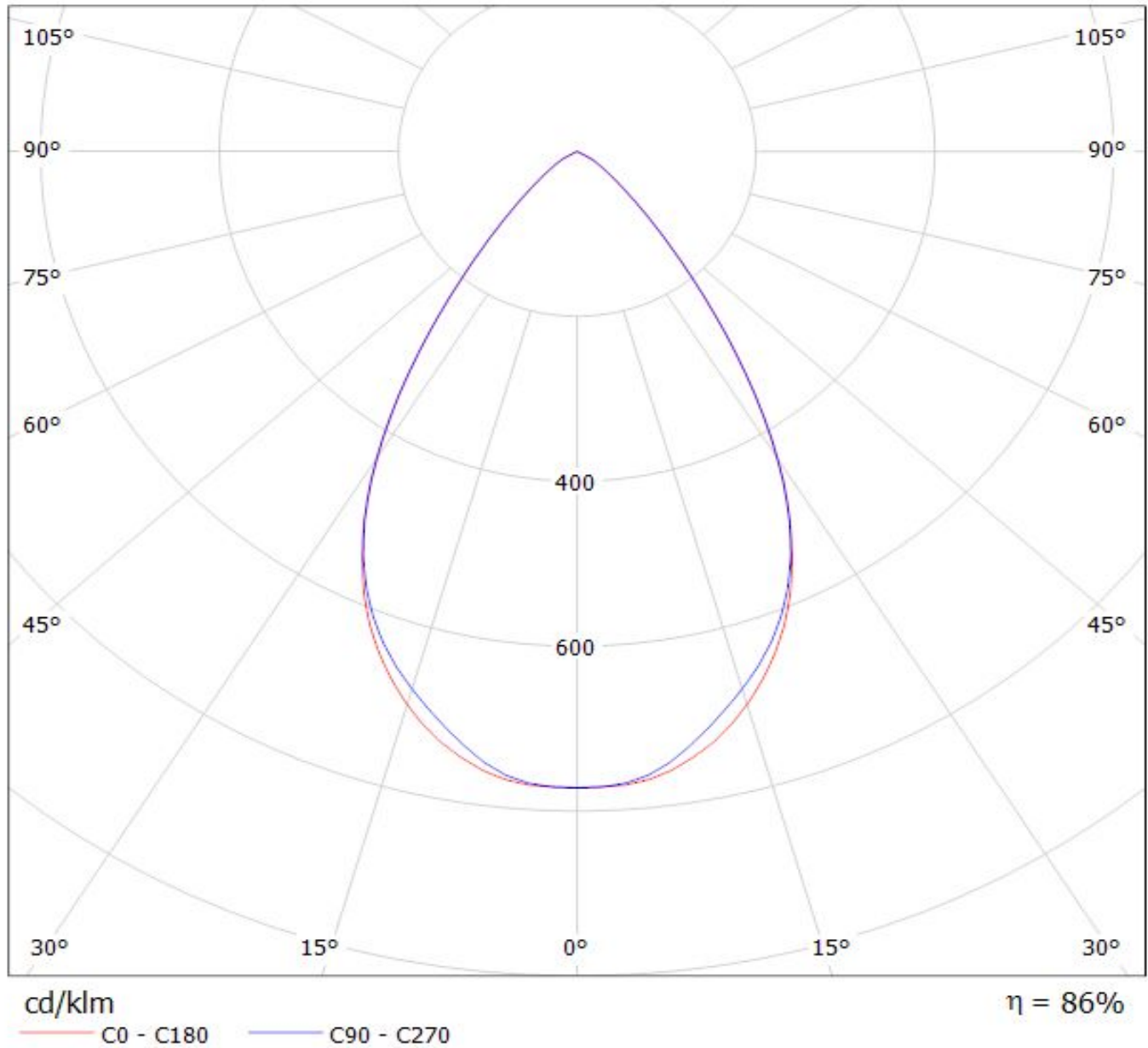

Ledil Oy CA12325_Laura-WW-PIN-WHT CA12325_Laura-WW-PIN-WHT Efficiency=86% / LDC
(Polar)

Luminaire: Ledil Oy CA12325_Laura-WW-PIN-WHT CA12325_Laura-WW-PIN-WHT Efficiency=86%
Lamps: 1 x Cree XP-E white 78lm @ 250mA

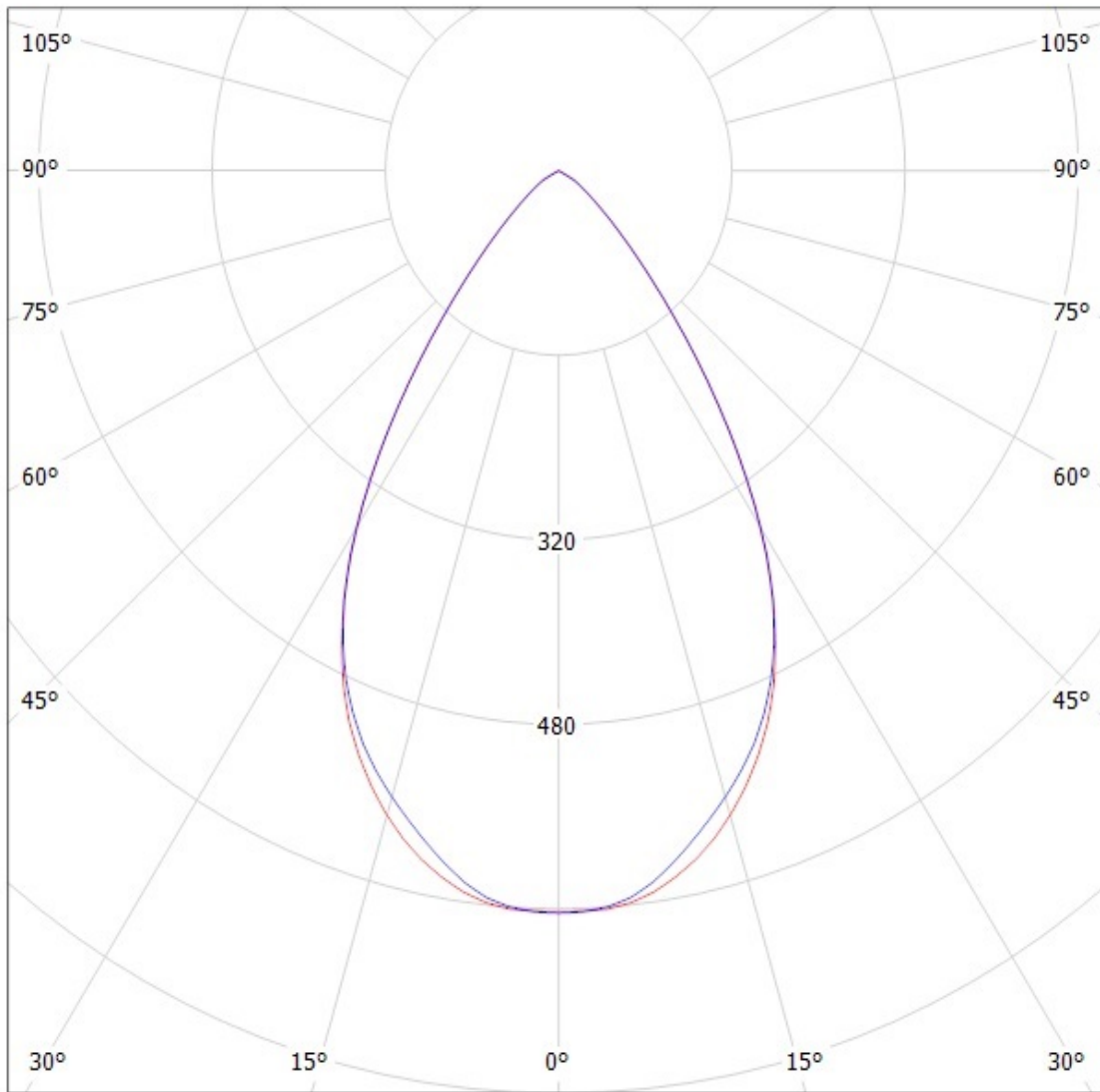

cd/klm

— C0 - C180 — C90 - C270

SIMULATED

Luminaire: LEDiL Oy CA11525_LAURA-R-W_(XP-E)

Lamps: 1 x Cree_XP-E_(XPEWHT-L1-3C0-Q5-0-06)_76.8195lm@250mA_P=0.792615W_I=0.250A

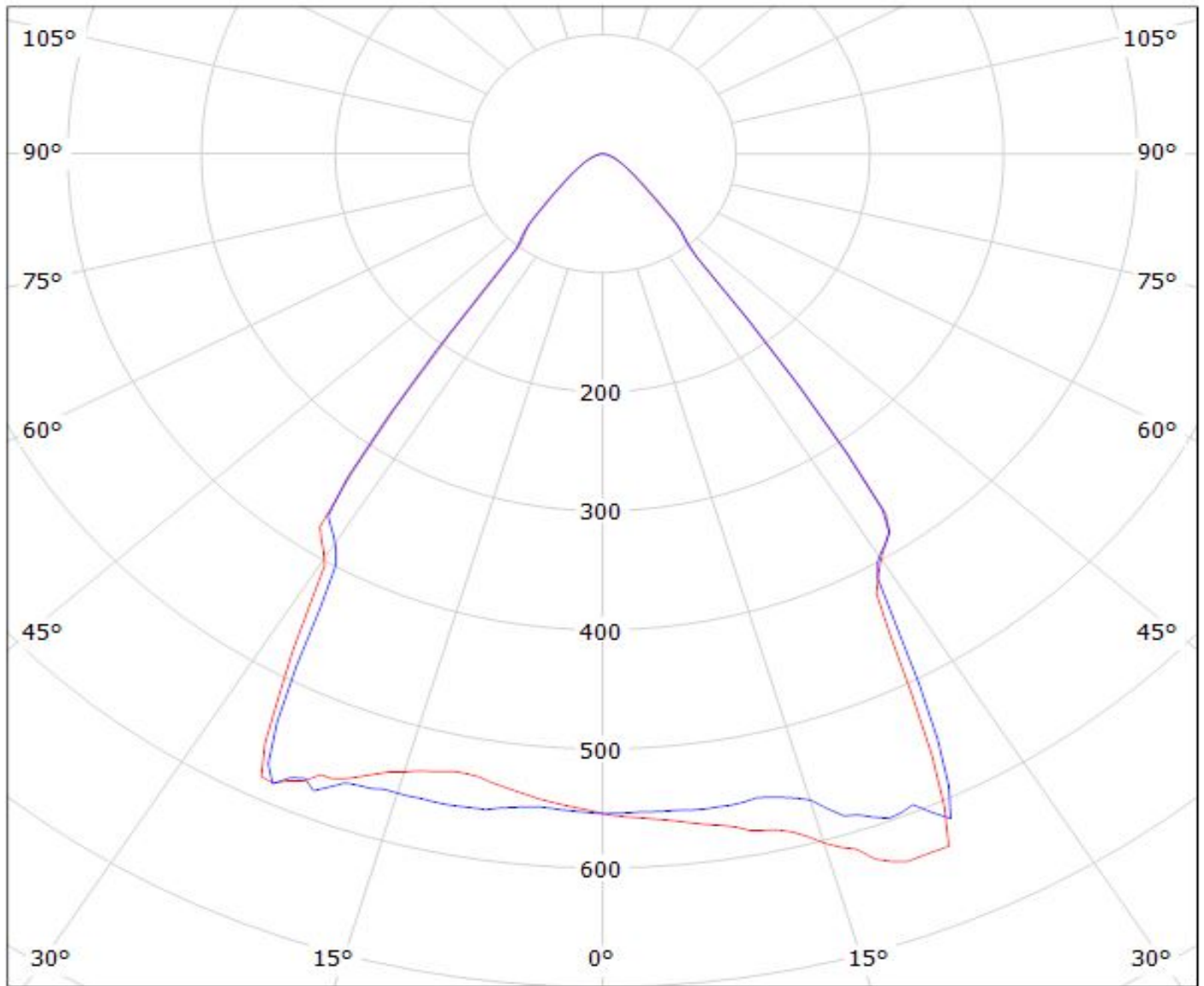

cd/klm

— C0 - C180

— C90 - C270

$\eta = 74\%$

Luminaire: LEDil Oy CA13636_G2-LAURA-R-XW-P_(XP-E)

Lamps: 1 x Cree XP-E (XPEWHT-L1-3C0-Q5-0-06) 78.31lm @ 250mA CCT=5241K P=0.8W I=250mA

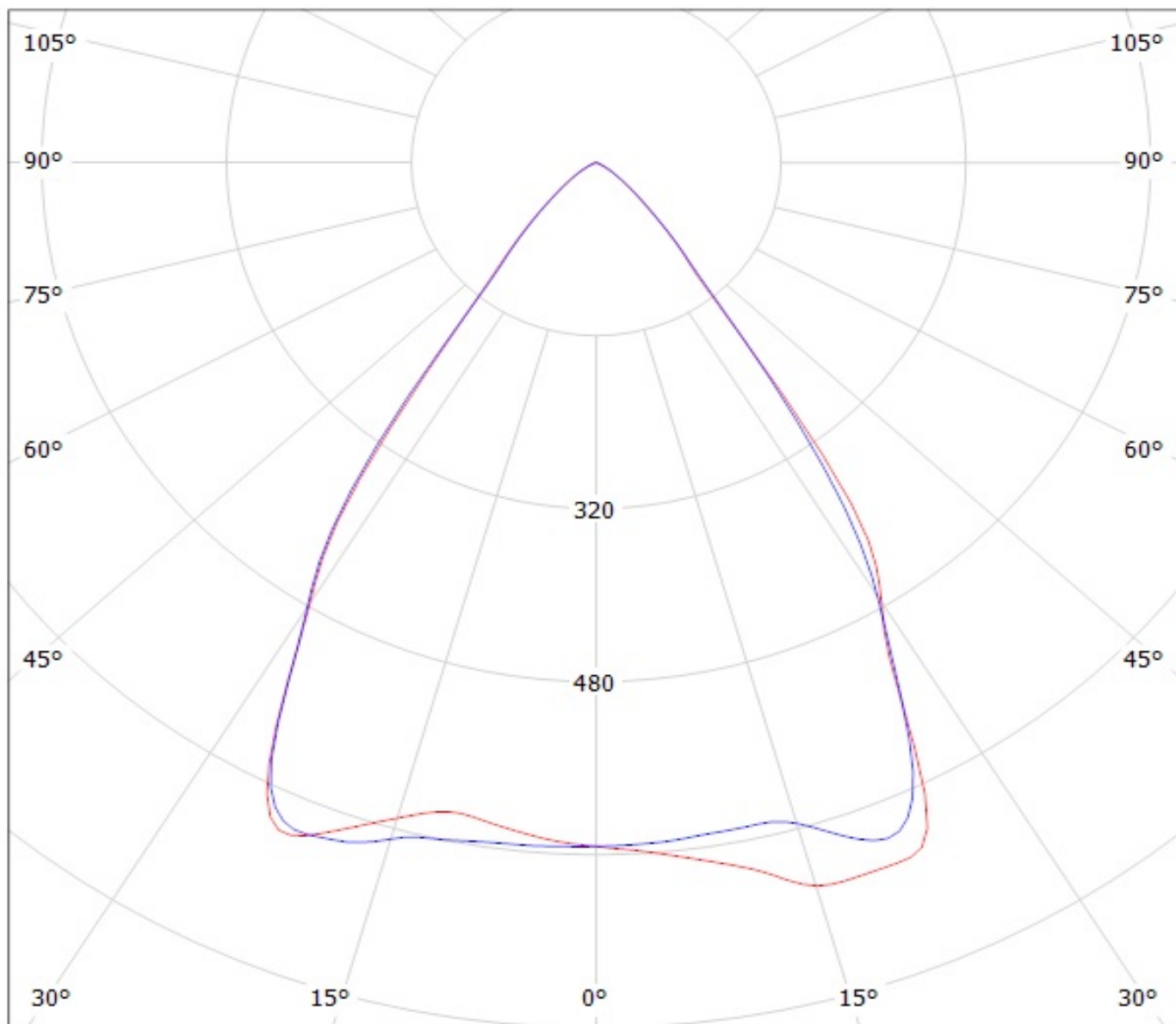

cd/klm

— C0 - C180

— C90 - C270

$\eta = 84\%$

X-ON Electronics

Largest Supplier of Electrical and Electronic Components

Click to view similar products for [LED Lighting Lenses Assemblies](#) category:

Click to view products by [Ledil](#) manufacturer:

Other Similar products are found below :

[FCN12592_LE1-D-COP](#) [CA11362_IRIS](#) [CA16127_OLGA-S](#) [CP16107_CARMEN-50-S-C](#) [CS15763_STRADA-2X2MX-8-VSM](#)
[C17171_DAISSY-8X1-SHD-MATT](#) [C17172_DAISSY-8X1-SHD-MATT-WHT](#) [C17173_DAISSY-4X1-WW-US](#) [C17341_DAISSY-4X1-WW-US-](#)
[D](#) [CS15759_HB-2X2MX-8-W](#) [CS15769_STRADA-2X2MX-8-T2-S](#) [CA16435_LXP2-SS-WAS](#) [CS13756_STRADA-IP-2X6-DWC-PC](#)
[CN16210_GABRIELLA-MIDI-W](#) [CP17138_CARMEN-M2-C-WHT](#) [CP17137_CARMEN-M2-C](#) [CA16015_STRADA-SQ-SCL](#)
[C16989_DAISSY-7X1-W2](#) [C17225_DAISSY-7X1-SHD-WHT-MATT](#) [C17296_ILONA-ZOOM-SUB](#) [FP15752_STRADA-2X2MXS-T3](#)
[C16590_DAISSY-4X1-SHD](#) [FP16562_LISA3-WWW-PIN](#) [CX15819_GABRIELLA-45-W](#) [C16870_DAISSY-7X1-WW](#) [CP12939_LARISA-RS-](#)
[CLIP16](#) [C14636_XTM-PF-ADAPTER](#) [CA14506_G2-LXP2-RS2](#) [CA14508_G2-LXP2-D](#) [CA14601_VERONICA-SQ-MINI-RS](#)
[FN14637_OLIVIA-S](#) [CP12943_LARISA-O-CLIP16](#) [FP11124_LISA2-O-PIN](#) [CP10444_LISA-SS](#) [CS14597_HB-IP-2X6-O](#)
[CP14995_FLORENTINA-HLD-O](#) [CP14994_FLORENTINA-HLD-M](#) [CP15775_CARMEN-M-C](#) [CS15158_STRADA-IP-2X6-T4-B](#)
[CS15363_STRADA-IP-2X6-T2-B](#) [CS15751_STRADA-2X2MX-8-DWC](#) [CS15886_STRADA-IP-2X6-T2-B-90](#) [CS16323_STRADELLA-IP-](#)
[28-HB-M](#) [FN14976_STELLA-DWC2](#) [FN15264_STELLA-HB-WWW](#) [FN15966_RONDA-WWW-C](#) [FN15971_RONDA-WAS-C](#)
[FP15073_ZORYA-SC-B](#) [CA15584_ZORYA-MINI-TAPE](#) [FA15229_ROSE-MRK-S](#)