

FLARE-MAXI-TAPE

34 x 33 mm lens with ~100° x 15° oval beam.
Assembly with installation tape.

TECHNICAL SPECIFICATIONS:

Dimensions	33.9 x 33.3 mm
Height	16.9 mm
Fastening	tape, pin
ROHS compliant	yes ⓘ



MATERIAL SPECIFICATIONS:

Component	Type	Material	Colour	Finish
FLARE-MAXI	Single lens	PMMA	clear	
FLARE-MAXI-TAPE	Tape	Acrylic foam	clear	

ORDERING INFORMATION:

Component	Type	Qty in box	MOQ	MPQ	Box weight (kg)
CA14366_FLARE-MAXI-TAPE	Single lens	864	144	72	9.7
» Box size:					

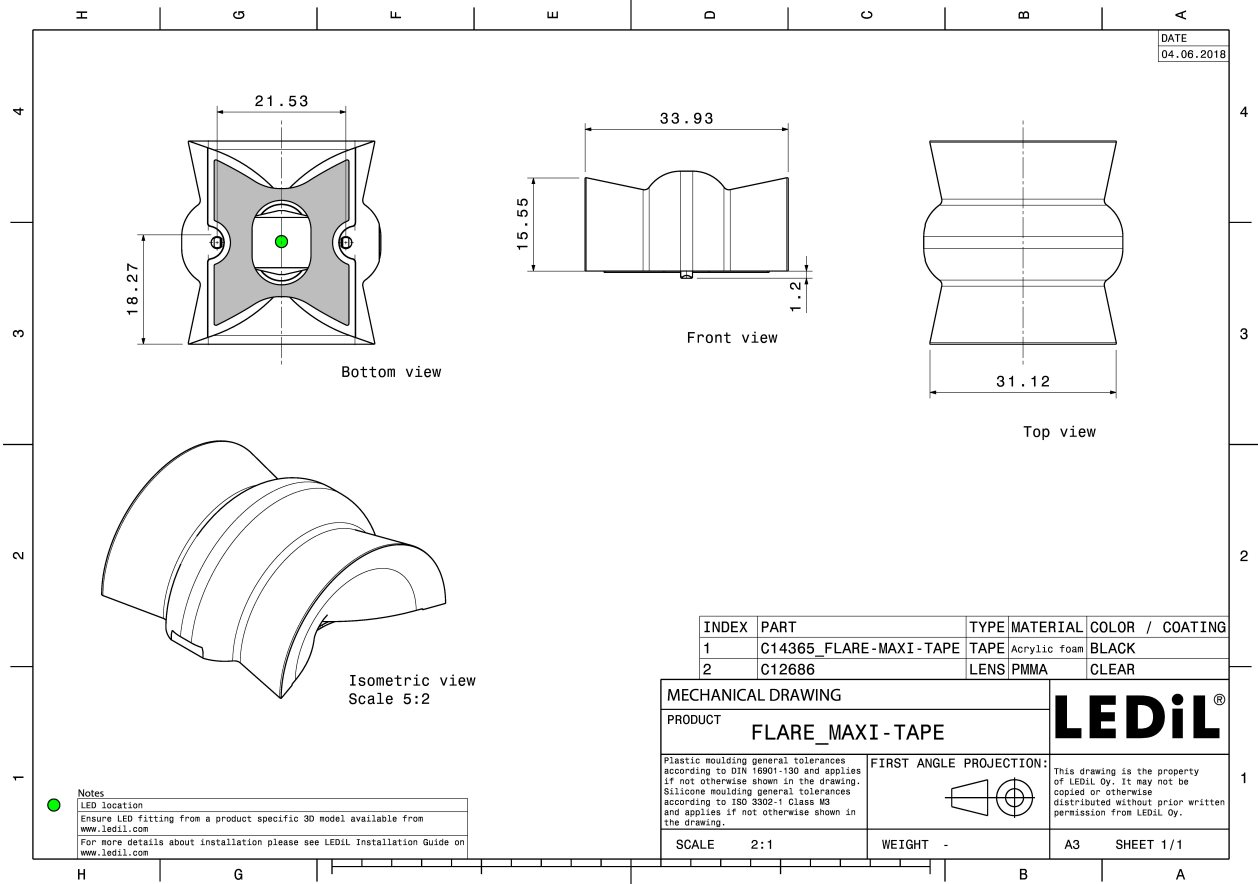

See also our general installation guide: www.ledil.com/installation_guide

PHOTOMETRIC DATA (MEASURED):

CREE LED

LED XM-L
FWHM / FWTM 96.0 + 15.0° / 175.0°
Efficiency 94 %
Peak intensity 2.1 cd/m
LEDs/each optic 1
Light colour White
Required components:

CREE LED

LED XM-L2
FWHM / FWTM 105.0 + 13.0°
Efficiency 96 %
LEDs/each optic 1
Light colour White
Required components:

CREE LED

LED XP-G
FWHM / FWTM 105.0 + 11.0° / 174.0°
Efficiency 94 %
Peak intensity 2.5 cd/m
LEDs/each optic 1
Light colour White
Required components:

CREE LED

LED XP-G2
FWHM / FWTM 96.0 + 10.0° / 162.0°
Efficiency 94 %
Peak intensity 3.1 cd/m
LEDs/each optic 1
Light colour White
Required components:

PHOTOMETRIC DATA (MEASURED):

CREE → LED

LED XP-L HD
 FWHM / FWTM 115.0 + 13.0° / 149.0 + 19.0°
 Efficiency 94 %
 Peak intensity 2.1 cd/lm
 LEDs/each optic 1
 Light colour White
 Required components:

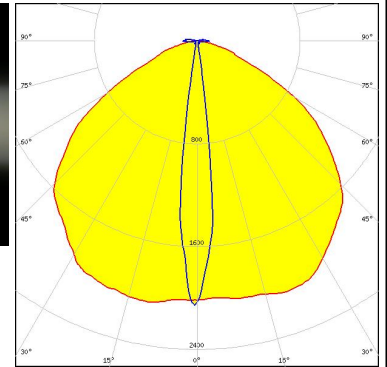
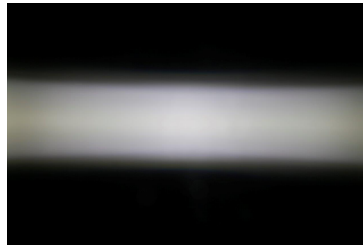

CREE → LED

LED XP-L2
 FWHM / FWTM 99.0 + 13.0° / 158.0 + 21.0°
 Efficiency 94 %
 Peak intensity 2 cd/lm
 LEDs/each optic 1
 Light colour White
 Required components:

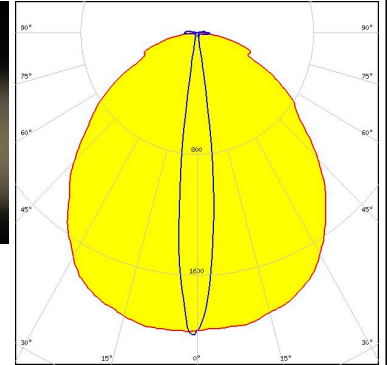

CREE → LED

LED XT-E
 FWHM / FWTM 96.0 + 10.0° / 183.0°
 Efficiency 94 %
 Peak intensity 2.5 cd/lm
 LEDs/each optic 1
 Light colour White
 Required components:

LUMILEDS

LED LUXEON Rebel ES
 FWHM / FWTM 91.0 + 10.0° / 164.0°
 Efficiency 94 %
 Peak intensity 2.8 cd/lm
 LEDs/each optic 1
 Light colour White
 Required components:

PHOTOMETRIC DATA (MEASURED):

LUMILEDS

LED LUXEON T
FWHM / FWTM 96.0 + 10.0° / 262.0°
Efficiency 92 %
Peak intensity 2.9 cd/lm
LEDs/each optic 1
Light colour White
Required components:

LUMILEDS

LED LUXEON TX
FWHM / FWTM 96.0 + 9.0° / 141.0°
Efficiency 94 %
Peak intensity 3.2 cd/lm
LEDs/each optic 1
Light colour White
Required components:

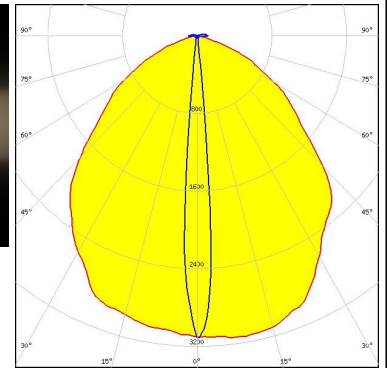

NICHIA

LED NCSxx19B
FWHM / FWTM 98.0 + 9.0° / 170.0°
Efficiency 94 %
Peak intensity 3.5 cd/lm
LEDs/each optic 1
Light colour White
Required components:

NICHIA

LED NVSxx19B/NVSxx19C
FWHM / FWTM 98.0 + 11.0° / 176.0°
Efficiency 94 %
Peak intensity 2.4 cd/lm
LEDs/each optic 1
Light colour White
Required components:

PHOTOMETRIC DATA (MEASURED):

OSRAM

Opto Semiconductors

LED OSLOM Square PC
 FWHM / FWTM 98.0 + 13.0° / 178.0°
 Efficiency 94 %
 Peak intensity 2.5 cd/m
 LEDs/each optic 1
 Light colour White
 Required components:

SAMSUNG

LED LH351Z
 FWHM / FWTM 94.0 + 8.8° / 125.0 + 13.0°
 Efficiency 94 %
 Peak intensity 3.6 cd/m
 LEDs/each optic 1
 Light colour White
 Required components:

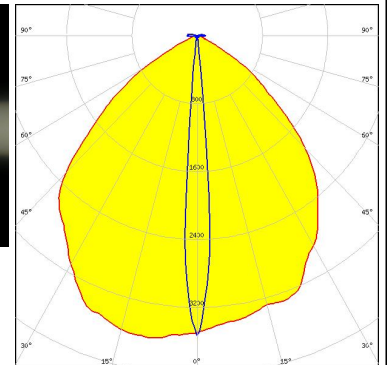
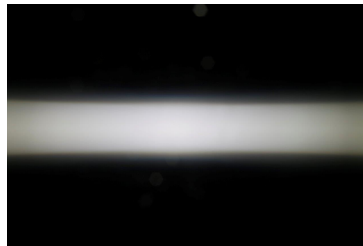

SEOUL SEMICONDUCTOR

LED Z5M3
 FWHM / FWTM 97.0 + 10.0° / 154.0 + 17.0°
 Efficiency 94 %
 Peak intensity 2.6 cd/m
 LEDs/each optic 1
 Light colour White
 Required components:

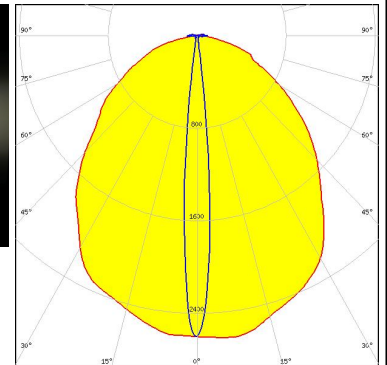
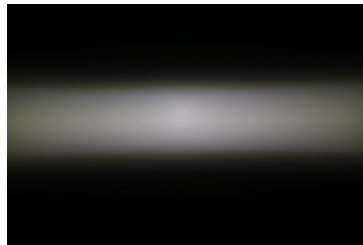

SEOUL SEMICONDUCTOR

LED Z8Y22P
 FWHM / FWTM 104.0 + 10.0° / 160.0 + 17.0°
 Efficiency 93 %
 Peak intensity 2.3 cd/m
 LEDs/each optic 1
 Light colour White
 Required components:

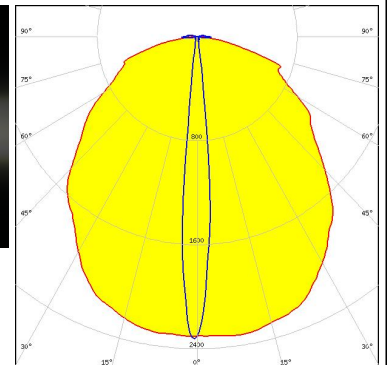
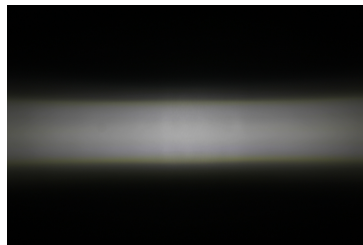

PHOTOMETRIC DATA (MEASURED):

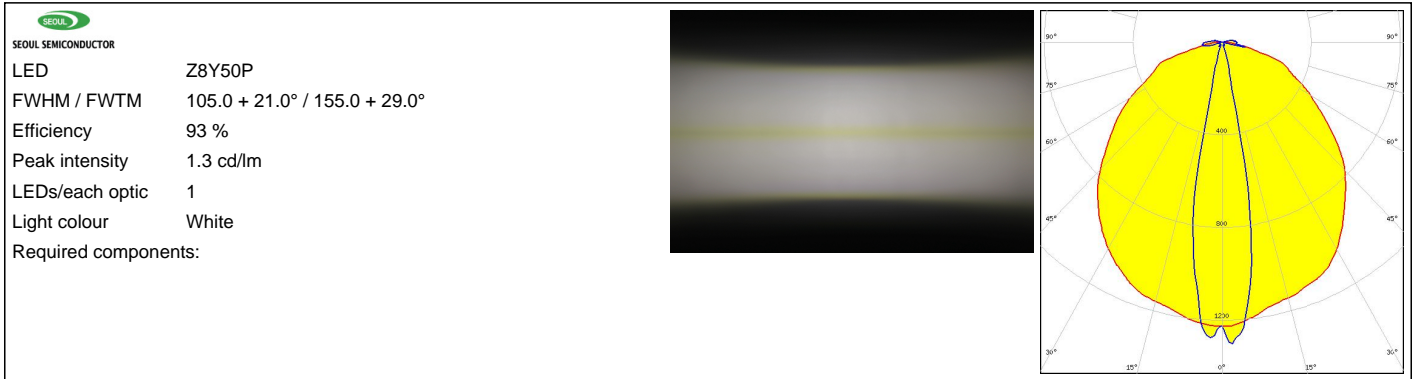

PHOTOMETRIC DATA (SIMULATED):

<p>CREE → LED</p> <p>LED: XD16 FWHM / FWTM: 62.0 + 8.0° / 146.0 + 15.0° Efficiency: 94 % Peak intensity: 3.2 cd/lm LEDs/each optic: 1 Light colour: White Required components:</p>	
<p>CREE → LED</p> <p>LED: XHP35 HD FWHM / FWTM: 89.0 + 14.0° / 139.0 + 20.0° Efficiency: 91 % Peak intensity: 2.2 cd/lm LEDs/each optic: 1 Light colour: White Required components:</p>	
<p>CREE → LED</p> <p>LED: XHP35 HI FWHM / FWTM: 82.0 + 10.0° / 136.0 + 15.0° Efficiency: 93 % Peak intensity: 3.2 cd/lm LEDs/each optic: 1 Light colour: White Required components:</p>	
<p>CREE → LED</p> <p>LED: XP-E2 FWHM / FWTM: 6.0 + 41.0° / 13.0 + 109.0° Efficiency: 94 % Peak intensity: 5.6 cd/lm LEDs/each optic: 1 Light colour: White Required components:</p>	

PHOTOMETRIC DATA (SIMULATED):

LUMILEDS

LED LUXEON CZ
 FWHM / FWTM 4.0 + 34.0° / 10.0 + 107.0°
 Efficiency 95 %
 Peak intensity 7.1 cd/lm
 LEDs/each optic 1
 Light colour Red
 Required components:

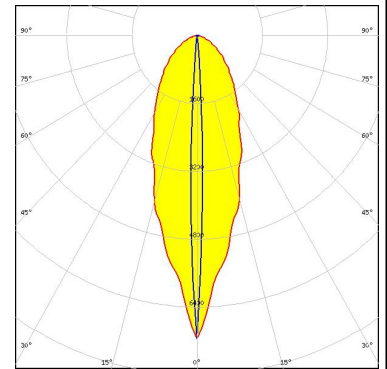

LUMILEDS

LED LUXEON H50-2
 FWHM / FWTM 9.5 + 64.0° / 137.0°
 Efficiency 92 %
 Peak intensity 3.6 cd/lm
 LEDs/each optic 1
 Light colour White
 Required components:

LUMILEDS

LED LUXEON Rubix (white)
 FWHM / FWTM 4.0 + 36.0° / 10.0 + 108.0°
 Efficiency 95 %
 Peak intensity 7 cd/lm
 LEDs/each optic 1
 Light colour Red
 Required components:

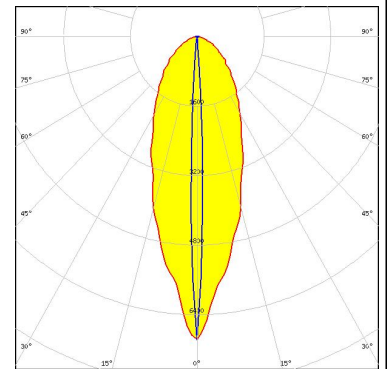

NICHIA

LED NCSxE17A
 FWHM / FWTM 90.0 + 9.0° / 150.0 + 18.0°
 Efficiency 94 %
 Peak intensity 3.1 cd/lm
 LEDs/each optic 1
 Light colour White
 Required components:

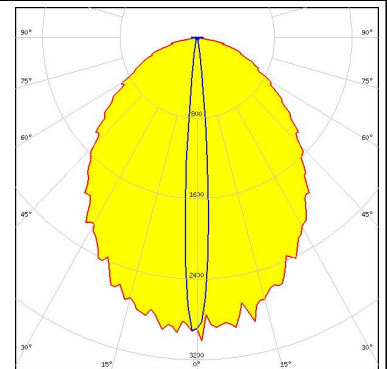

PHOTOMETRIC DATA (SIMULATED):

OSRAM

Opto Semiconductors

LED OSLOM Square EC
 FWHM / FWTM 8.0 + 53.0° / 116.0 + 15.0°
 Efficiency 94 %
 Peak intensity 4 cd/lm
 LEDs/each optic 1
 Light colour White
 Required components:

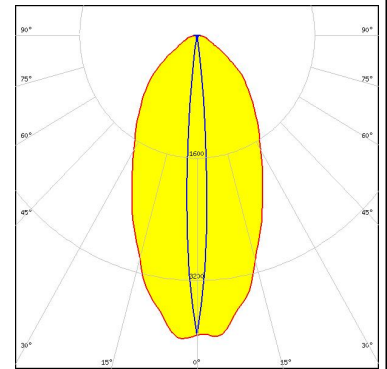

OSRAM

Opto Semiconductors

LED OSLOM SSL 150
 FWHM / FWTM 6.0 + 58.0° / 12.0 + 131.0°
 Efficiency 94 %
 Peak intensity 4.7 cd/lm
 LEDs/each optic 1
 Light colour Red
 Required components:

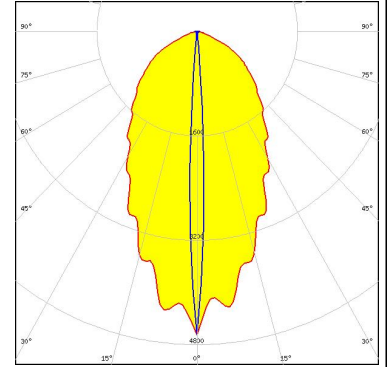

SAMSUNG

LED LH351B
 FWHM / FWTM 67.0 + 10.0° / 126.0 + 17.0°
 Efficiency 94 %
 Peak intensity 3.1 cd/lm
 LEDs/each optic 1
 Light colour White
 Required components:

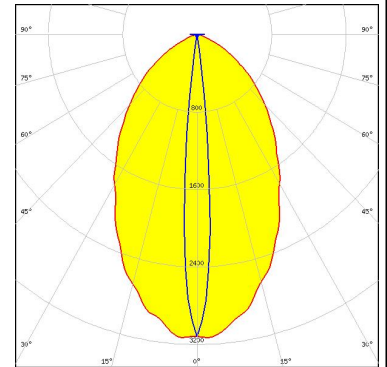

SAMSUNG

LED LH351C
 FWHM / FWTM 71.0 + 11.0° / 126.0 + 18.0°
 Efficiency 94 %
 Peak intensity 3 cd/lm
 LEDs/each optic 1
 Light colour White
 Required components:

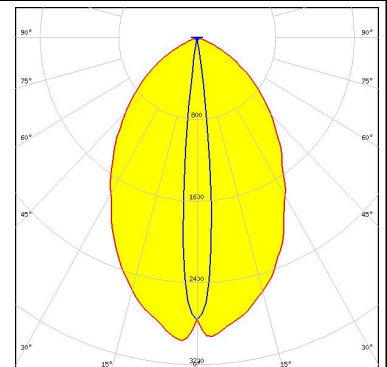

GENERAL INFORMATION:

NOTE: The typical beam angle will be changed by different color, chip size and chip position tolerance. The typical total beam angle is the full angle measured where the luminous intensity is half of the peak value.

MATERIALS:

As part of our continuous research and improvement processes, and to ensure the best possible quality and availability of our products, LEDiL reserves the right to change material grades without notice.

PRODUCT DATA USER AGREEMENT AND DISCLAIMER:

The measured data in the provided downloadable LEDiL Product Datasheets and Mechanical 2D-Drawings is rounded and provided as reference for planning. LEDiL Oy's optical specifications have been verified by conducting performance testing of the products in accordance with the company's quality system. The reported data are averaged results of multiple measurements with typical variation. LEDiL Oy reserves the right to without prior notification make changes and improvements to its products.

LEDiL Oy assumes neither warranty, nor guarantee nor any other liability of any kind for the contents and correctness of the provided data. The provided data has been generated with highest diligence but the provided data may in reality not represent the complete possible variation range of all intrinsic parameters. Therefore, in certain cases a deviation from the provided data could occur.

LEDiL Oy reserves the right to undertake technical changes of its products without further notification which could lead to changes in the provided data. LEDiL Oy assumes no liability of any kind for the possible deviation from any provided data or any other damage resulting from the usage of the provided data.

The user agrees to this disclaimer and user agreement with the download or usage of the provided files.

LEDiL Oy

Joensuunkatu 13
FI-24240 SALO
Finland

LEDiL Inc.

228 West Page Street
Suite D
Sycamore IL 60178
USA

Ledil Optics Technology (Shenzhen) Co., Ltd.

405 , Block B
Casic Motor Building
Shenzhen 518057
P.R.CHINA

Local sales and technical support

[www.ledil.com/
where_to_buy](http://www.ledil.com/where_to_buy)

Shipping locations

Salo, Finland
Hong Kong, China

Distribution Partners

[www.ledil.com/
where_to_buy](http://www.ledil.com/where_to_buy)

X-ON Electronics

Largest Supplier of Electrical and Electronic Components

Click to view similar products for [LED Lighting Lenses Assemblies](#) category:

Click to view products by [Ledil](#) manufacturer:

Other Similar products are found below :

[FCN12592_LE1-D-COP](#) [CA16129_OLGA-W](#) [CA16370_HB-SQ-W](#) [FN15972_RONDA-ZT45-C](#) [CS15759_HB-2X2MX-8-W](#)
[CA16435_LXP2-SS-WAS](#) [CN16210_GABRIELLA-MIDI-W](#) [CP17137_CARMEN-M2-C](#) [CA16015_STRADA-SQ-SCL](#) [CP17594_TINA-SC-](#)
[RS](#) [CS15767_HB-2X2MX-8-M](#) [CP10960_RGBX-SS](#) [CP12395_LXP3-W](#) [CP12939_LARISA-RS-CLIP16](#) [C14636_XTM-PF-ADAPTER](#)
[CA11819_STRADA-SQ-T-DW](#) [CA14508_G2-LXP2-D](#) [CA14601_VERONICA-SQ-MINI-RS](#) [FCP13895_SEANNA-A](#) [CP12943_LARISA-](#)
[O-CLIP16](#) [FP11124_LISA2-O-PIN](#) [CS14597_HB-IP-2X6-O](#) [CP14995_FLORENTINA-HLD-O](#) [CS15158_STRADA-IP-2X6-T4-B](#)
[CS16323_STRADELLA-IP-28-HB-M](#) [FN14976_STELLA-DWC2](#) [FN15264_STELLA-HB-WWW](#) [CA15584_ZORYA-MINI-TAPE](#)
[FA15229_ROSE-MRK-S](#) [FA15232_ROSE-MRK-M](#) [FA15233_ROSE-MRK-W](#) [FCN13552_CRYSTAL-RS](#) [FN15552_RONDA-W](#)
[FS15626_FLORENCE-3R-IP-Z90](#) [FS15786_FLORENCE-3R-IP-Z60](#) [FS15847_FLORENCE-3R-IP-O](#) [CA14505_G2-LXP2-RS2-P](#)
[FCN12775_IRIS-O](#) [CP15304_LARISA-RS-PIN](#) [FN15679_RONDA-S](#) [CA15519_VERONICA-SQ-MINI-D](#) [FP14414_LISA2-O-PIN](#)
[LL01CR-DF60L06-M2](#) [FN15993_RONDA-O](#) [FN15977_RONDA-WAS2](#) [CA14366_FLARE-MAXI-TAPE](#) [CA14442_VERONICA-SQ-W](#)
[CA14509_G2-LXP2-M-P](#) [CA15231_VERONICA-SQ-MINI-W](#) [FP11002_LISA2-W-PIN](#)