

## VERONICA-SQ-M

~30° medium beam

### TECHNICAL SPECIFICATIONS:

Dimensions	22.5 x 22.5 mm
Height	11.8 mm
Fastening	tape, pin
ROHS compliant	yes ⓘ

### MATERIAL SPECIFICATIONS:

Component	Type	Material	Colour	Finish
VERONICA-SQ-M	Single lens	PMMA	clear	
VERONICA-TAPE	Tape	Acrylic foam	clear	

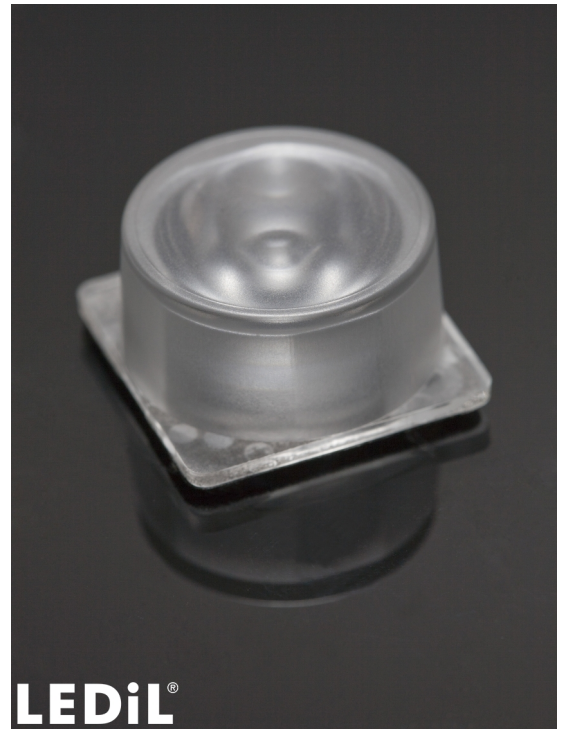

### ORDERING INFORMATION:

Component	Type	Qty in box	MOQ	MPQ	Box weight (kg)
CA14461_VERONICA-SQ-M » Box size: 476 x 273 x 197 mm	Single lens	1980	360	180	8.2

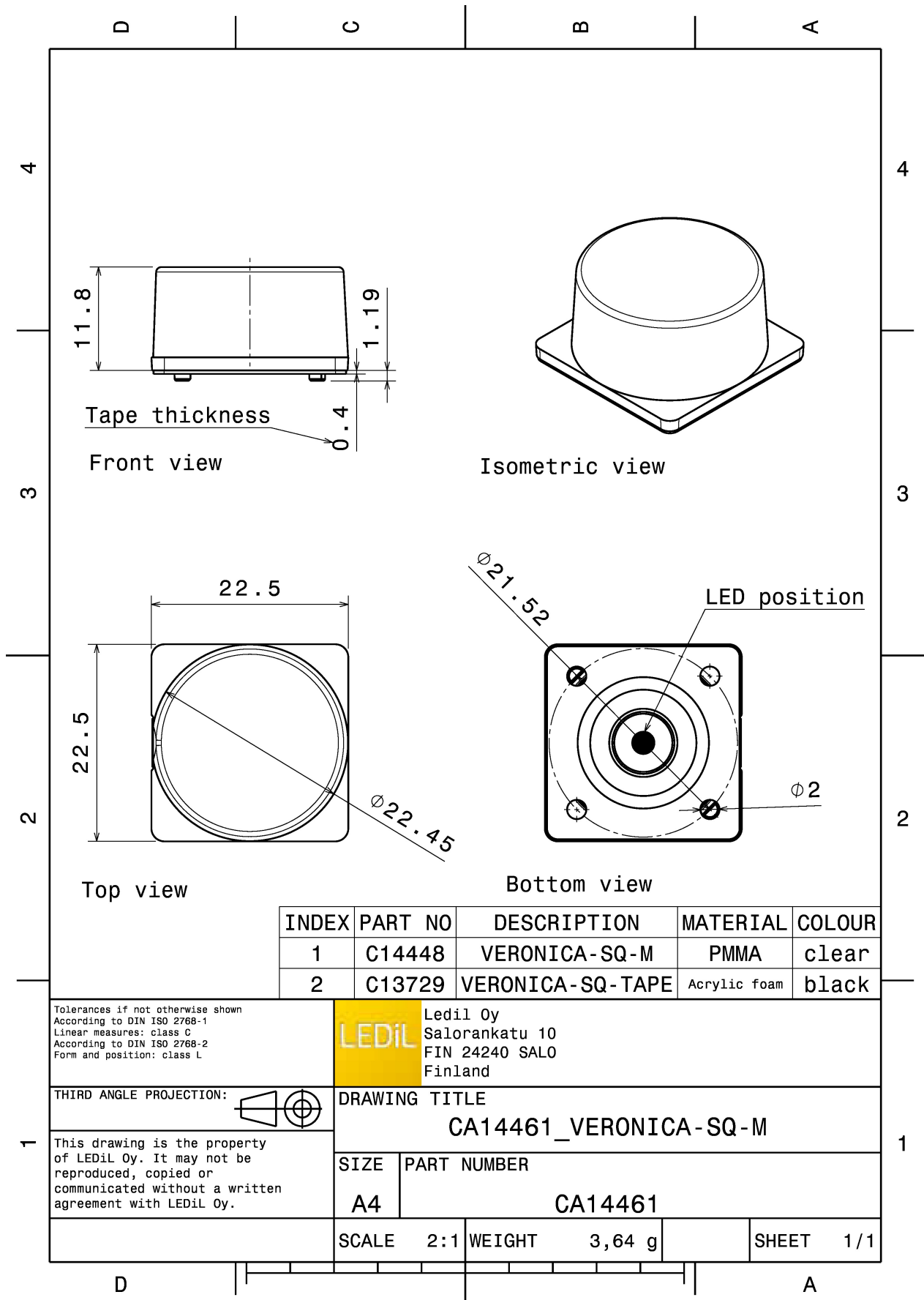

See also our general installation guide: [www.ledil.com/installation\\_guide](http://www.ledil.com/installation_guide)

#### PHOTOMETRIC DATA (MEASURED):

##### CREE → LED

LED XB-H  
 FWHM / FWTM 29.0° / 52.0°  
 Efficiency 91 %  
 Peak intensity 3 cd/lm  
 LEDs/each optic 1  
 Light colour White  
 Required components:

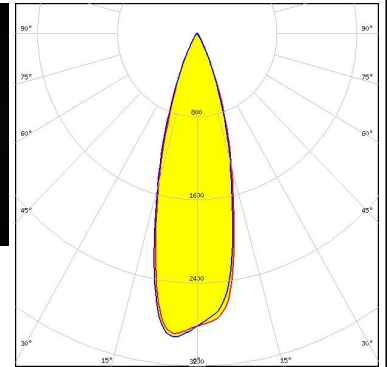
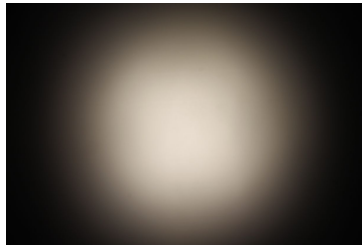

##### CREE → LED

LED XHP35 HD  
 FWHM / FWTM 40.0° / 64.0°  
 Efficiency 88 %  
 Peak intensity 1.9 cd/lm  
 LEDs/each optic 1  
 Light colour White  
 Required components:

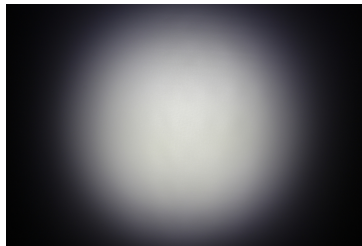

##### CREE → LED

LED XHP35 HI  
 FWHM / FWTM 33.0° / 54.0°  
 Efficiency 88 %  
 Peak intensity 2.7 cd/lm  
 LEDs/each optic 1  
 Light colour White  
 Required components:

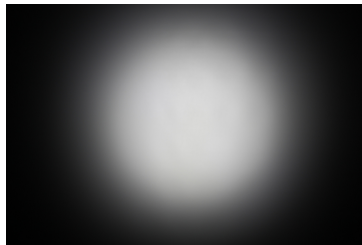





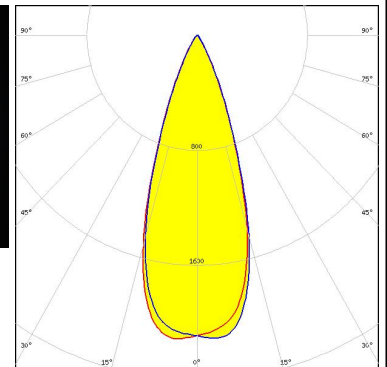
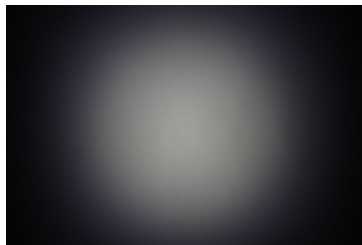

##### CREE → LED

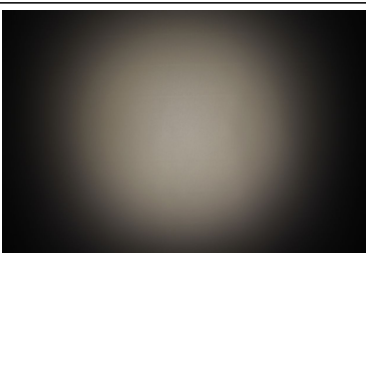
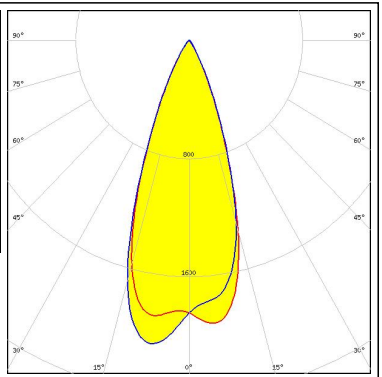
LED XM-L  
 FWHM / FWTM 37.0° / 59.0°  
 Efficiency 92 %  
 Peak intensity 2.1 cd/lm  
 LEDs/each optic 1  
 Light colour White  
 Required components:

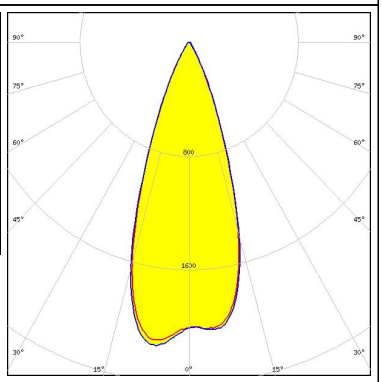

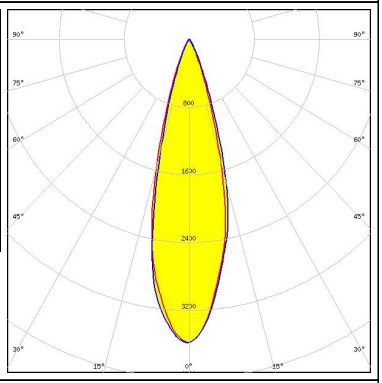
#### PHOTOMETRIC DATA (MEASURED):

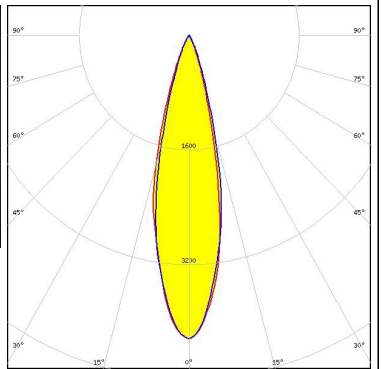
<p><b>CREE</b> ⇄ <b>LED</b></p> <p>LED XM-L2            FWHM / FWTM 38.0° / 60.0°            Efficiency 91 %            Peak intensity 2.1 cd/lm            LEDs/each optic 1            Light colour White            Required components:</p>		
<p><b>CREE</b> ⇄ <b>LED</b></p> <p>LED XM-L3            FWHM / FWTM 37.0° / 58.0°            Efficiency 95 %            Peak intensity 2.2 cd/lm            LEDs/each optic 1            Light colour White            Required components:</p>		
<p><b>CREE</b> ⇄ <b>LED</b></p> <p>LED XP-E            FWHM / FWTM 28.0° / 47.0°            Efficiency 93 %            Peak intensity 3.6 cd/lm            LEDs/each optic 1            Light colour White            Required components:</p>		
<p><b>CREE</b> ⇄ <b>LED</b></p> <p>LED XP-E2            FWHM / FWTM 25.0° / 45.0°            Efficiency 94 %            Peak intensity 4.2 cd/lm            LEDs/each optic 1            Light colour White            Required components:</p>		



#### PHOTOMETRIC DATA (MEASURED):

##### CREE LED

LED XP-G2  
 FWHM / FWTM 30.0° / 52.0°  
 Efficiency 89 %  
 Peak intensity 3.1 cd/lm  
 LEDs/each optic 1  
 Light colour White  
 Required components:



##### CREE LED

LED XP-L HD  
 FWHM / FWTM 40.0° / 61.0°  
 Efficiency 91 %  
 Peak intensity 2 cd/lm  
 LEDs/each optic 1  
 Light colour White  
 Required components:

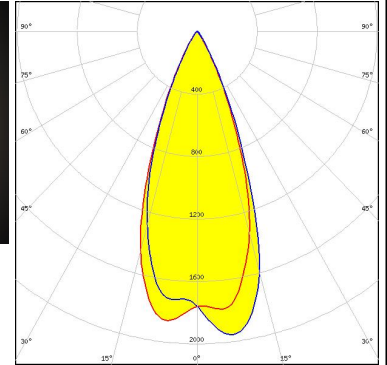

##### CREE LED

LED XP-L2  
 FWHM / FWTM 37.0° / 60.0°  
 Efficiency 87 %  
 Peak intensity 2 cd/lm  
 LEDs/each optic 1  
 Light colour White  
 Required components:

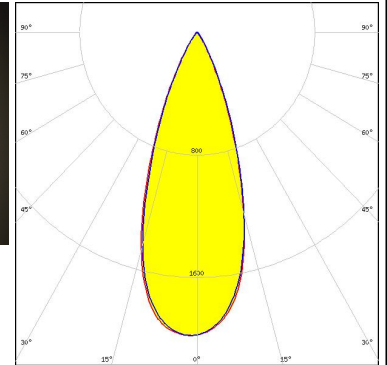
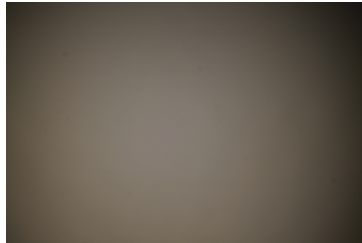

##### CREE LED

LED XT-E  
 FWHM / FWTM 27.0° / 50.0°  
 Efficiency 87 %  
 Peak intensity 3.5 cd/lm  
 LEDs/each optic 1  
 Light colour White  
 Required components:

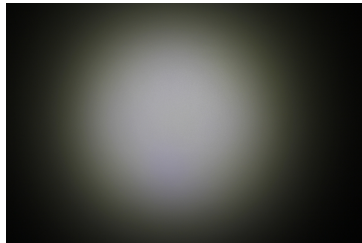

#### PHOTOMETRIC DATA (MEASURED):

##### LUMILEDS

LED LUXEON 3030 2D (Round LES)  
 FWHM / FWTM 24.0° / 44.0°  
 Efficiency 94 %  
 Peak intensity 4.5 cd/lm  
 LEDs/each optic 1  
 Light colour White  
 Required components:

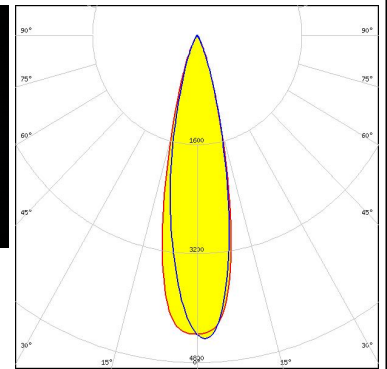

##### LUMILEDS

LED LUXEON A  
 FWHM / FWTM 30.0° / 52.0°  
 Efficiency 91 %  
 Peak intensity 3 cd/lm  
 LEDs/each optic 1  
 Light colour White  
 Required components:

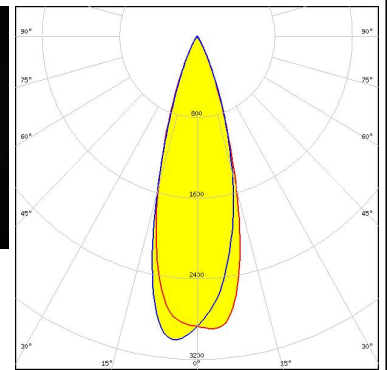
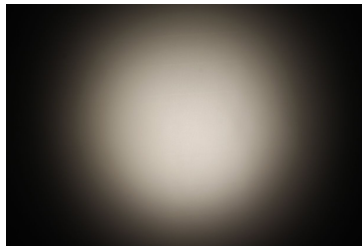

##### LUMILEDS

LED LUXEON MZ  
 FWHM / FWTM 32.0° / 52.0°  
 Efficiency 93 %  
 Peak intensity 2.7 cd/lm  
 LEDs/each optic 1  
 Light colour White  
 Required components:

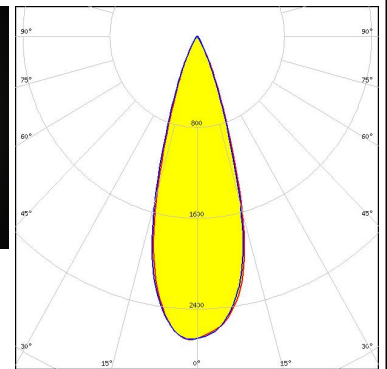
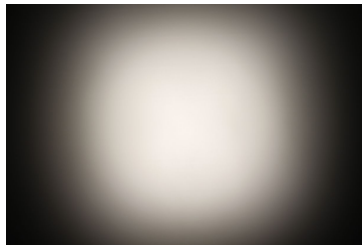

##### LUMILEDS

LED LUXEON R  
 FWHM / FWTM 30.0° / 51.0°  
 Efficiency 91 %  
 Peak intensity 3 cd/lm  
 LEDs/each optic 1  
 Light colour White  
 Required components:

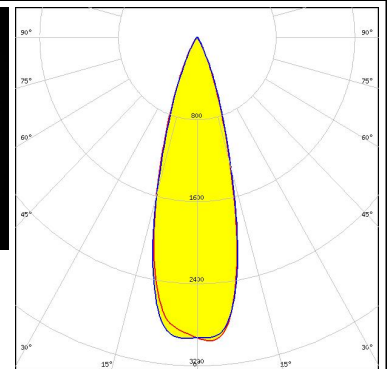
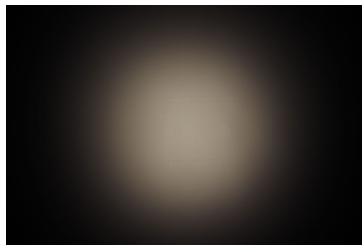

#### PHOTOMETRIC DATA (MEASURED):

##### LUMILEDS

LED LUXEON Rebel  
 FWHM / FWTM 26.0° / 47.0°  
 Efficiency 92 %  
 Peak intensity 3.6 cd/lm  
 LEDs/each optic 1  
 Light colour White  
 Required components:

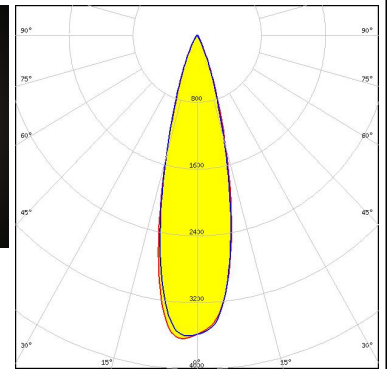
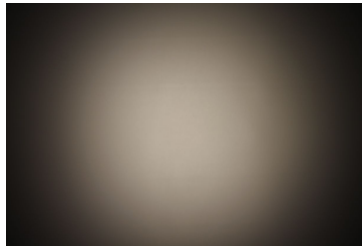

##### LUMILEDS

LED LUXEON Rebel ES  
 FWHM / FWTM 27.0° / 48.0°  
 Efficiency 91 %  
 Peak intensity 3.5 cd/lm  
 LEDs/each optic 1  
 Light colour White  
 Required components:

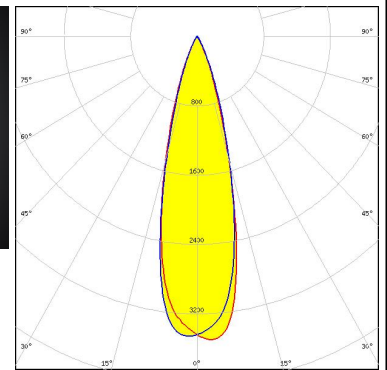
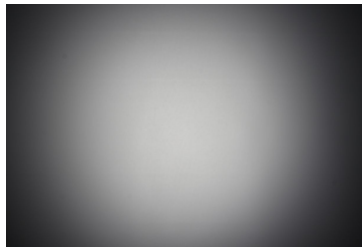

##### LUMILEDS

LED LUXEON T  
 FWHM / FWTM 30.0° / 51.0°  
 Efficiency 93 %  
 Peak intensity 3 cd/lm  
 LEDs/each optic 1  
 Light colour White  
 Required components:

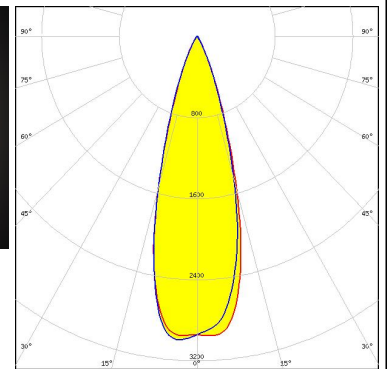
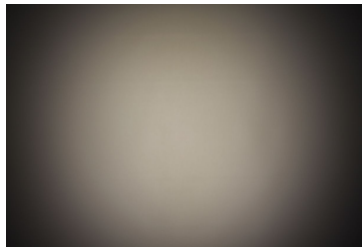



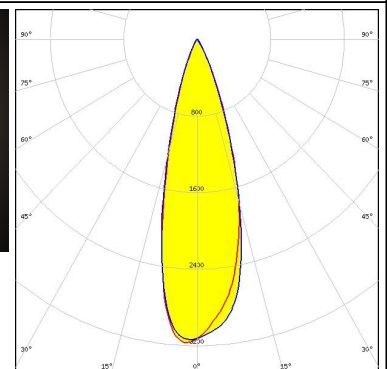
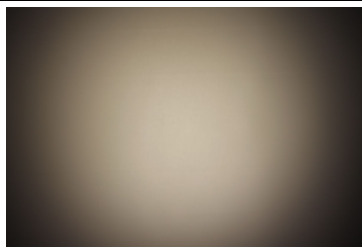

##### LUMILEDS

LED LUXEON TX  
 FWHM / FWTM 30.0° / 50.0°  
 Efficiency 92 %  
 Peak intensity 3.2 cd/lm  
 LEDs/each optic 1  
 Light colour White  
 Required components:

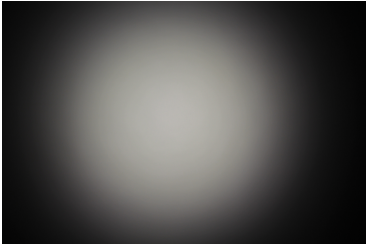
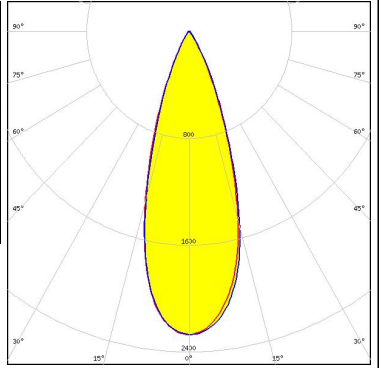

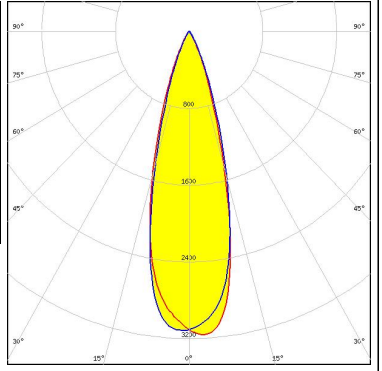
#### PHOTOMETRIC DATA (MEASURED):

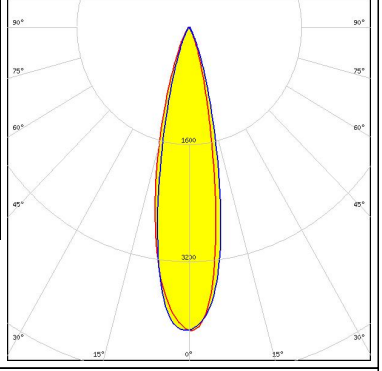
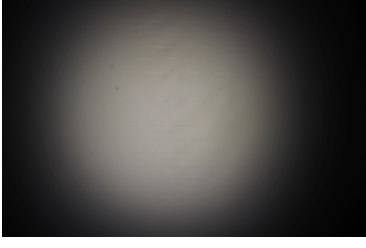
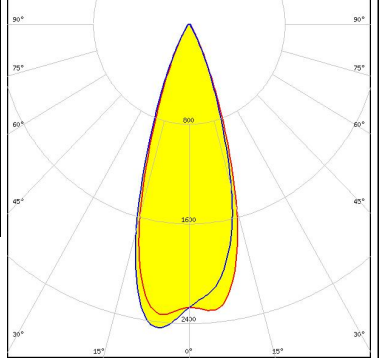
<p><b>LUMILEDS</b></p> <p>LED LUXEON V</p> <p>FWHM / FWTM 35.0° / 58.0°</p> <p>Efficiency 90 %</p> <p>Peak intensity 2.3 cd/m</p> <p>LEDs/each optic 1</p> <p>Light colour White</p> <p>Required components:</p>		
<p><b>LUMILEDS</b></p> <p>LED LUXEON V2</p> <p>FWHM / FWTM 29.0° / 51.0°</p> <p>Efficiency 94 %</p> <p>Peak intensity 3.2 cd/m</p> <p>LEDs/each optic 1</p> <p>Light colour White</p> <p>Required components:</p>		
<p><b>NICHIA</b></p> <p>LED NCSxx19B</p> <p>FWHM / FWTM 23.0° / 44.0°</p> <p>Efficiency 92 %</p> <p>Peak intensity 4.1 cd/m</p> <p>LEDs/each optic 1</p> <p>Light colour White</p> <p>Required components:</p>		
<p><b>NICHIA</b></p> <p>LED NVSW219F</p> <p>FWHM / FWTM 35.0° / 56.0°</p> <p>Efficiency 94 %</p> <p>Peak intensity 2.5 cd/m</p> <p>LEDs/each optic 1</p> <p>Light colour White</p> <p>Required components:</p>		

#### PHOTOMETRIC DATA (MEASURED):



LED NVSxx19B/NVSxx19C  
 FWHM / FWTM 30.0° / 51.0°  
 Efficiency 91 %  
 Peak intensity 2.9 cd/lm  
 LEDs/each optic 1  
 Light colour White  
 Required components:

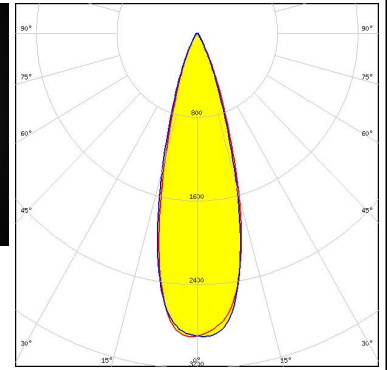
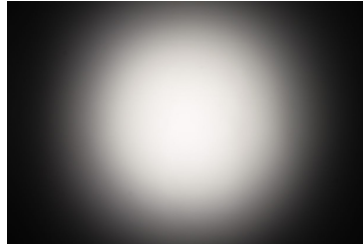

LED NWSx229A  
 FWHM / FWTM 39.0° / 59.0°  
 Efficiency 89 %  
 Peak intensity 2 cd/lm  
 LEDs/each optic 1  
 Light colour White  
 Required components:

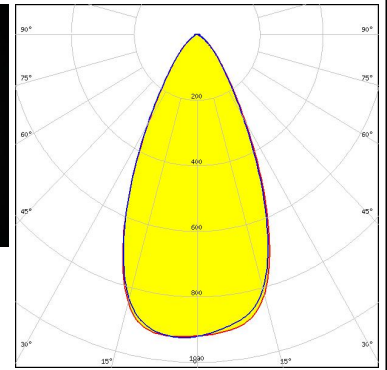
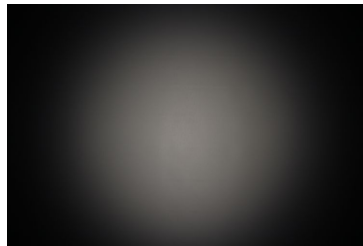

OSRAM Opto Semiconductors  
 LED OSLON Square EC  
 FWHM / FWTM 28.0° / 50.0°  
 Efficiency 91 %  
 Peak intensity 3.4 cd/lm  
 LEDs/each optic 1  
 Light colour White  
 Required components:

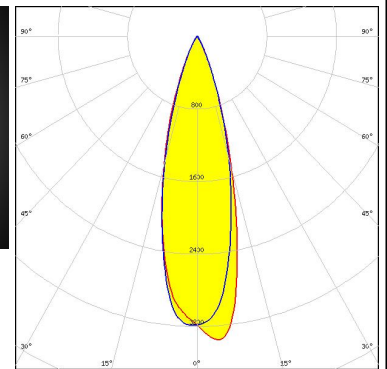
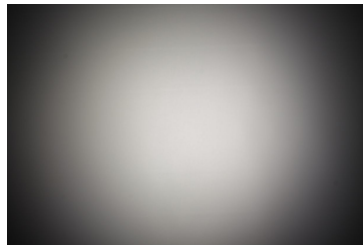

OSRAM Opto Semiconductors  
 LED OSLON Square PC  
 FWHM / FWTM 29.0° / 51.0°  
 Efficiency 91 %  
 Peak intensity 3 cd/lm  
 LEDs/each optic 1  
 Light colour White  
 Required components:

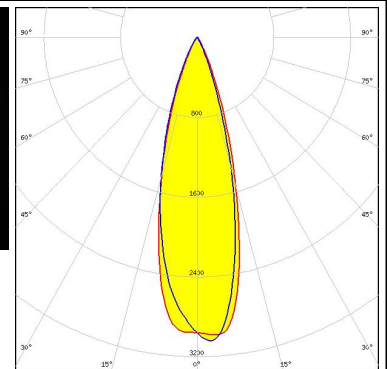
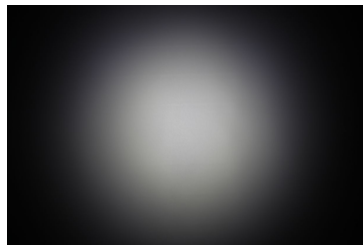



#### PHOTOMETRIC DATA (MEASURED):

### SAMSUNG

LED LH181A  
 FWHM / FWTM 21.0° / 42.0°  
 Efficiency 94 %  
 Peak intensity 4.3 cd/m  
 LEDs/each optic 1  
 Light colour White  
 Required components:

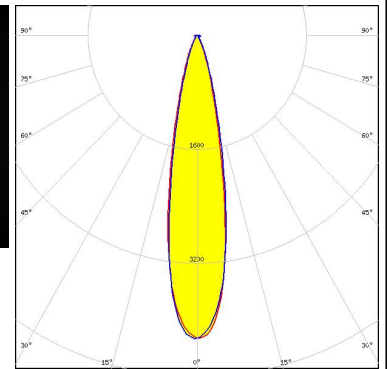
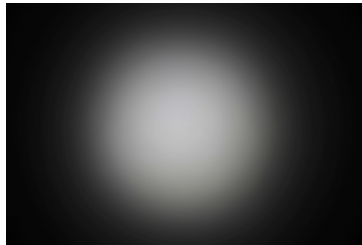

### SAMSUNG

LED LH181B  
 FWHM / FWTM 23.0° / 42.0°  
 Efficiency 94 %  
 Peak intensity 4.5 cd/m  
 LEDs/each optic 1  
 Light colour White  
 Required components:

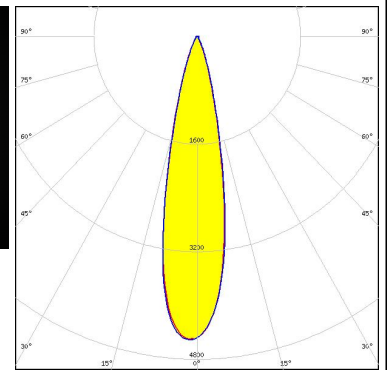
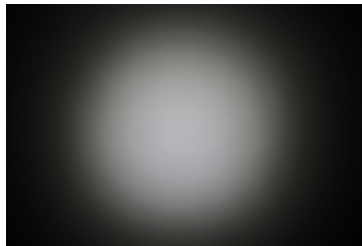

SEOUL SEMICONDUCTOR  
 LED Z5M3  
 FWHM / FWTM 31.0° / 54.0°  
 Efficiency 94 %  
 Peak intensity 2.7 cd/m  
 LEDs/each optic 1  
 Light colour White  
 Required components:

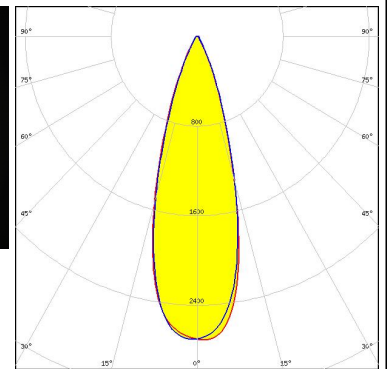
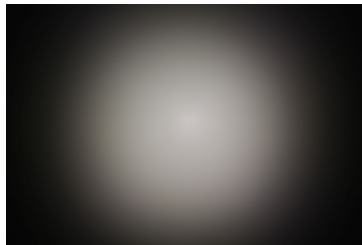

SEOUL SEMICONDUCTOR  
 LED Z8Y22P  
 FWHM / FWTM 29.0° / 50.0°  
 Efficiency 88 %  
 Peak intensity 2.9 cd/m  
 LEDs/each optic 1  
 Light colour White  
 Required components:

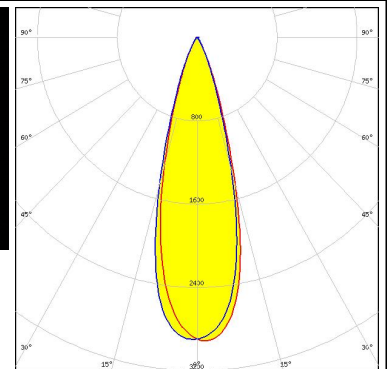
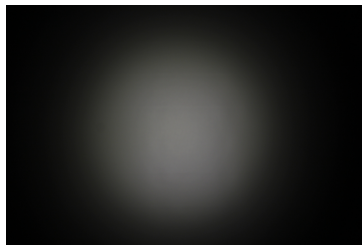



### PHOTOMETRIC DATA (MEASURED):

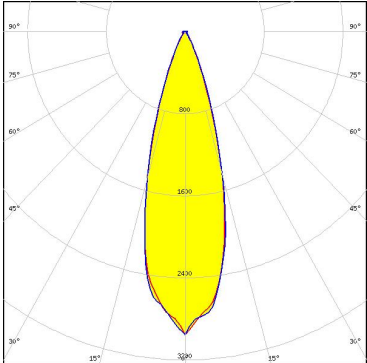
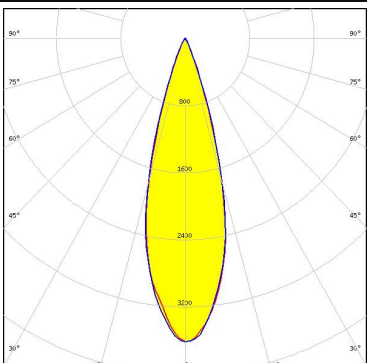
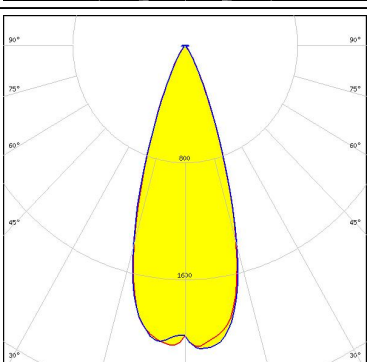
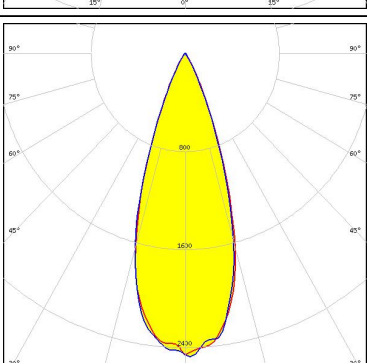

#### PHOTOMETRIC DATA (SIMULATED):

<p><b>CREE</b> LED</p> <p>LED: XHP35.2            FWHM / FWTM: 30.0° / 52.0°            Efficiency: 95 %            Peak intensity: 3 cd/lm            LEDs/each optic: 1            Light colour: White            Required components:</p>	
<p><b>LUMILEDS</b></p> <p>LED: LUXEON C            FWHM / FWTM: 29.0° / 47.0°            Efficiency: 94 %            Peak intensity: 3.7 cd/lm            LEDs/each optic: 1            Light colour: White            Required components:</p>	
<p><b>NICHIA</b></p> <p>LED: NCSxE17A            FWHM / FWTM: 36.0° / 56.0°            Efficiency: 93 %            Peak intensity: 2.1 cd/lm            LEDs/each optic: 4            Light colour: White            Required components:</p>	
<p><b>NICHIA</b></p> <p>LED: NV4WB35AM            FWHM / FWTM: 36.0° / 56.0°            Efficiency: 96 %            Peak intensity: 2.5 cd/lm            LEDs/each optic: 1            Light colour: White            Required components:</p>	

#### PHOTOMETRIC DATA (SIMULATED):

#### OSRAM

Opto Semiconductors

LED OSCONIQ C 2424  
 FWHM / FWTM 44.0° / 66.0°  
 Efficiency 97 %  
 Peak intensity 1.5 cd/lm  
 LEDs/each optic 4  
 Light colour White  
 Required components:

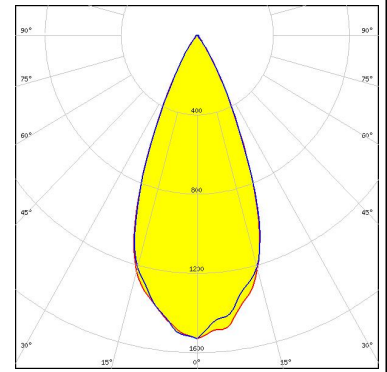

#### OSRAM

Opto Semiconductors

LED OSCONIQ P 3030  
 FWHM / FWTM 23.0° / 42.0°  
 Efficiency 96 %  
 Peak intensity 5 cd/lm  
 LEDs/each optic 1  
 Light colour White  
 Required components:

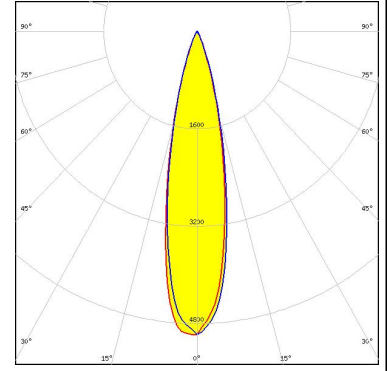

#### SAMSUNG

LED LM28xB Series  
 FWHM / FWTM 29.0° / 50.0°  
 Efficiency 94 %  
 Peak intensity 3.5 cd/lm  
 LEDs/each optic 1  
 Light colour White  
 Required components:

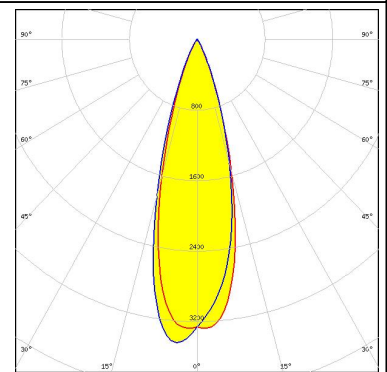

SEOUL SEMICONDUCTOR

LED MJT 3030  
 FWHM / FWTM 27.0° / 46.0°  
 Efficiency 96 %  
 Peak intensity 3.9 cd/lm  
 LEDs/each optic 1  
 Light colour White  
 Required components:

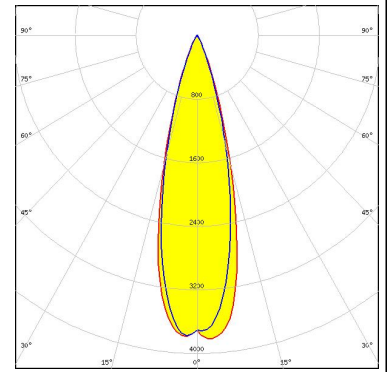

#### PHOTOMETRIC DATA (SIMULATED):

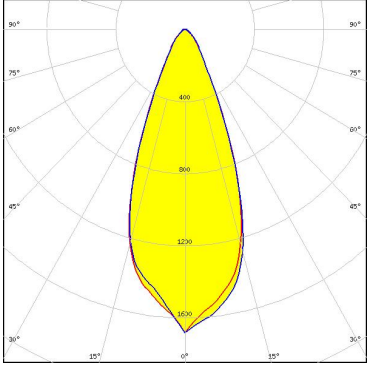
 SEOUL SEMICONDUCTOR	LED Z5M4 FWHM / FWTM 29.0° / 49.0° Efficiency 96 % Peak intensity 3.5 cd/lm LEDs/each optic 1 Light colour White Required components:	
 SEOUL SEMICONDUCTOR	LED Z8Y22T FWHM / FWTM 28.0° / 47.0° Efficiency 94 % Peak intensity 3.8 cd/lm LEDs/each optic 1 Light colour White Required components:	

### GENERAL INFORMATION:

NOTE: The typical beam angle will be changed by different color, chip size and chip position tolerance. The typical total beam angle is the full angle measured where the luminous intensity is half of the peak value.

### MATERIALS:

As part of our continuous research and improvement processes, and to ensure the best possible quality and availability of our products, LEDiL reserves the right to change material grades without notice.

### PRODUCT DATA USER AGREEMENT AND DISCLAIMER:

The measured data in the provided downloadable LEDiL Product Datasheets and Mechanical 2D-Drawings is rounded and provided as reference for planning. LEDiL Oy's optical specifications have been verified by conducting performance testing of the products in accordance with the company's quality system. The reported data are averaged results of multiple measurements with typical variation. LEDiL Oy reserves the right to without prior notification make changes and improvements to its products.

LEDiL Oy assumes neither warranty, nor guarantee nor any other liability of any kind for the contents and correctness of the provided data. The provided data has been generated with highest diligence but the provided data may in reality not represent the complete possible variation range of all intrinsic parameters. Therefore, in certain cases a deviation from the provided data could occur.

LEDiL Oy reserves the right to undertake technical changes of its products without further notification which could lead to changes in the provided data. LEDiL Oy assumes no liability of any kind for the possible deviation from any provided data or any other damage resulting from the usage of the provided data.

The user agrees to this disclaimer and user agreement with the download or usage of the provided files.

#### LEDiL Oy

Joensuunkatu 13  
FI-24240 SALO  
Finland

#### LEDiL Inc.

228 West Page Street  
Suite D  
Sycamore IL 60178  
USA

#### Ledil Optics Technology (Shenzhen) Co., Ltd.

# 405 , Block B  
Casic Motor Building  
Shenzhen 518057  
P.R.CHINA

#### Local sales and technical support

[www.ledil.com/  
where\\_to\\_buy](http://www.ledil.com/where_to_buy)

#### Shipping locations

Salo, Finland  
Hong Kong, China

#### Distribution Partners

[www.ledil.com/  
where\\_to\\_buy](http://www.ledil.com/where_to_buy)

## X-ON Electronics

Largest Supplier of Electrical and Electronic Components

*Click to view similar products for [LED Lighting Lenses Assemblies](#) category:*

*Click to view products by [Ledil](#) manufacturer:*

Other Similar products are found below :

[FCN12592\\_LE1-D-COP](#) [CA16129\\_OLGA-W](#) [CA16370\\_HB-SQ-W](#) [FN15972\\_RONDA-ZT45-C](#) [CS15759\\_HB-2X2MX-8-W](#)  
[CA16435\\_LXP2-SS-WAS](#) [CN16210\\_GABRIELLA-MIDI-W](#) [CP17137\\_CARMEN-M2-C](#) [CA16015\\_STRADA-SQ-SCL](#) [CP17594\\_TINA-SC-](#)  
[RS](#) [CS15767\\_HB-2X2MX-8-M](#) [CP10960\\_RGBX-SS](#) [CP12395\\_LXP3-W](#) [CP12939\\_LARISA-RS-CLIP16](#) [C14636\\_XTM-PF-ADAPTER](#)  
[CA11819\\_STRADA-SQ-T-DW](#) [CA14508\\_G2-LXP2-D](#) [CA14601\\_VERONICA-SQ-MINI-RS](#) [FCP13895\\_SEANNA-A](#) [CP12943\\_LARISA-](#)  
[O-CLIP16](#) [FP11124\\_LISA2-O-PIN](#) [CS14597\\_HB-IP-2X6-O](#) [CP14995\\_FLORENTINA-HLD-O](#) [CS15158\\_STRADA-IP-2X6-T4-B](#)  
[CS16323\\_STRADELLA-IP-28-HB-M](#) [FN14976\\_STELLA-DWC2](#) [FN15264\\_STELLA-HB-WWW](#) [CA15584\\_ZORYA-MINI-TAPE](#)  
[FA15229\\_ROSE-MRK-S](#) [FA15232\\_ROSE-MRK-M](#) [FA15233\\_ROSE-MRK-W](#) [FCN13552\\_CRYSTAL-RS](#) [FN15552\\_RONDA-W](#)  
[FS15626\\_FLORENCE-3R-IP-Z90](#) [FS15786\\_FLORENCE-3R-IP-Z60](#) [FS15847\\_FLORENCE-3R-IP-O](#) [CA14505\\_G2-LXP2-RS2-P](#)  
[FCN12775\\_IRIS-O](#) [CP15304\\_LARISA-RS-PIN](#) [FN15679\\_RONDA-S](#) [CA15519\\_VERONICA-SQ-MINI-D](#) [FP14414\\_LISA2-O-PIN](#)  
[LL01CR-DF60L06-M2](#) [FN15993\\_RONDA-O](#) [FN15977\\_RONDA-WAS2](#) [CA14366\\_FLARE-MAXI-TAPE](#) [CA14442\\_VERONICA-SQ-W](#)  
[CA14509\\_G2-LXP2-M-P](#) [CA15231\\_VERONICA-SQ-MINI-W](#) [FP11002\\_LISA2-W-PIN](#)