

G2-LXP2-D-P

~14° diffused spot beam with light, black holder.
Assembly with location pins and installation
tape.

TECHNICAL SPECIFICATIONS:

Dimensions	Ø 21.8 mm
Height	14.7 mm
Fastening	tape, pin
ROHS compliant	yes ⓘ



MATERIAL SPECIFICATIONS:

Component	Type	Material	Colour	Finish
LXP2-D	Single lens	PMMA	clear	
LXP2-LT-HLD	Holder	PC	black	
HEIDI-TAPE	Tape	PU tape	black	

ORDERING INFORMATION:

Component	Type	Qty in box	MOQ	MPQ	Box weight (kg)
CA14507_G2-LXP2-D-P » Box size: 480 x 280 x 300 mm	Single lens	1680		112	8.3

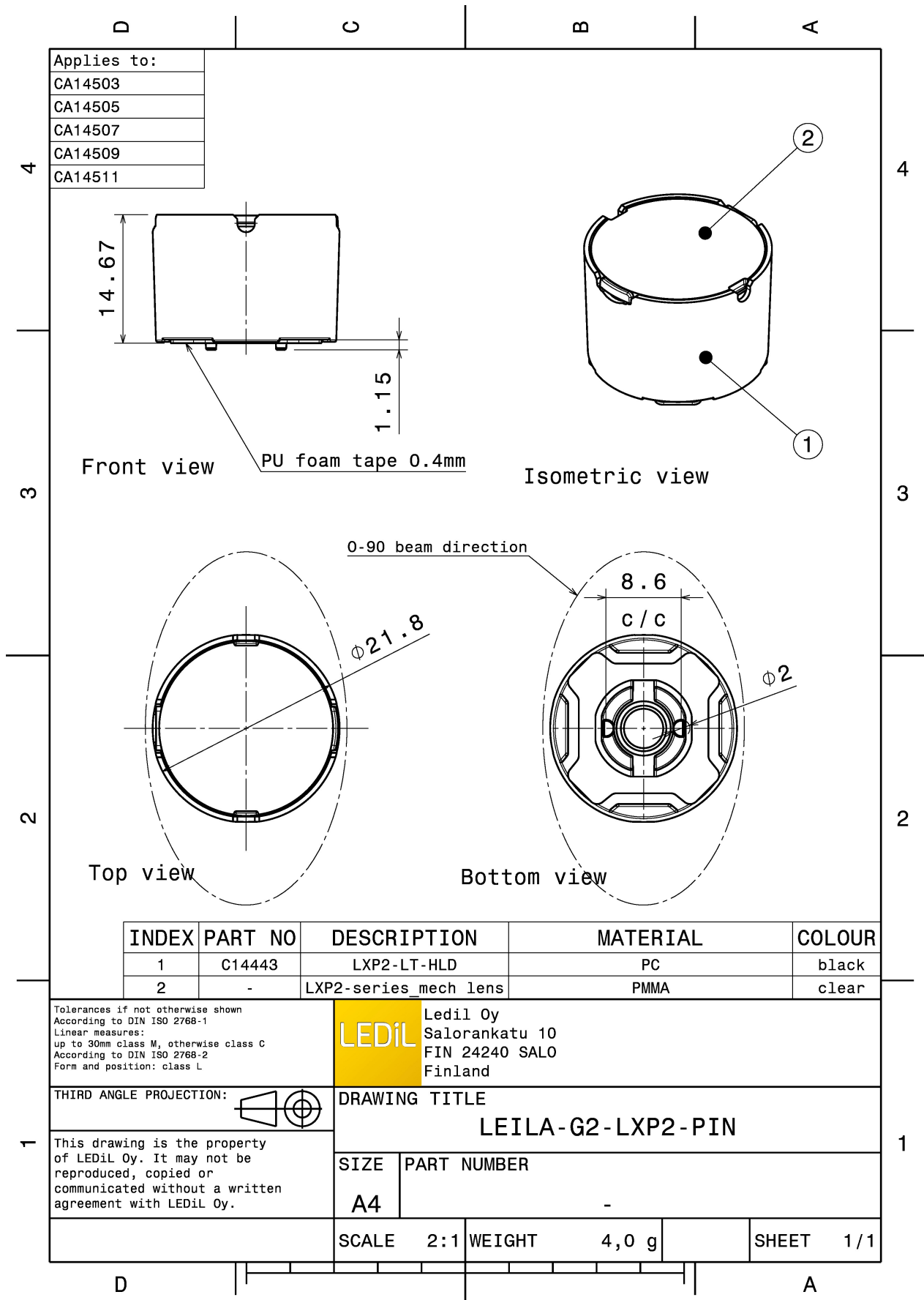

INDEX	PART NO	DESCRIPTION	MATERIAL	COLOUR
1	C14443	LXP2-LT-HLD	PC	black
2	-	LXP2-series_mech lens	PMMA	clear

Tolerances if not otherwise shown
 According to DIN ISO 2768-1
 Linear measures:
 up to 30mm class M, otherwise class C
 According to DIN ISO 2768-2
 Form and position: class L

LEDiL Ledil Oy
 Salorankatu 10
 FIN 24240 SALO
 Finland

THIRD ANGLE PROJECTION:

DRAWING TITLE
LEILA-G2-LXP2-PIN

This drawing is the property of LEDiL Oy. It may not be reproduced, copied or communicated without a written agreement with LEDiL Oy.

SIZE	PART NUMBER
A4	-

SCALE	2:1	WEIGHT	4,0 g	SHEET	1/1
-------	-----	--------	-------	-------	-----

See also our general installation guide: www.ledil.com/installation_guide

PHOTOMETRIC DATA (MEASURED):

CREE → LED

LED XD16
 FWHM / FWTM 13.0° / 32.0°
 Efficiency 78 %
 Peak intensity 7.4 cd/lm
 LEDs/each optic 1
 Light colour White
 Required components:

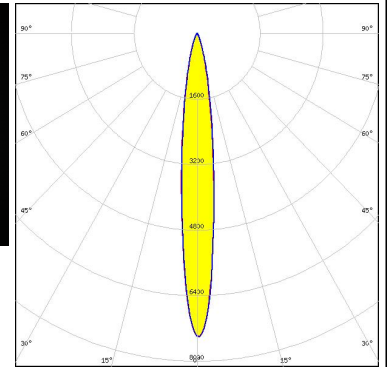

CREE → LED

LED XP-E
 FWHM / FWTM 9.7° / 22.0°
 Efficiency 88 %
 Peak intensity 19.9 cd/lm
 LEDs/each optic 1
 Light colour White
 Required components:

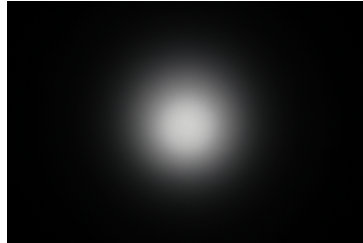

CREE → LED

LED XQ-E HD
 FWHM / FWTM 11.0° / 25.0°
 Efficiency 85 %
 Peak intensity 11.8 cd/lm
 LEDs/each optic 1
 Light colour White
 Required components:

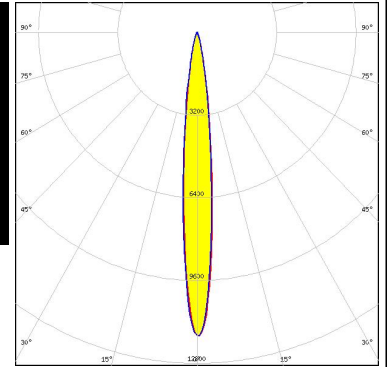
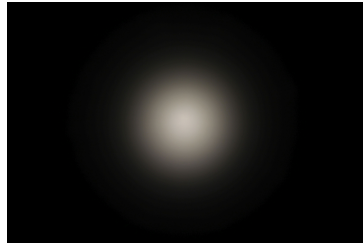

CREE → LED

LED XQ-E HI
 FWHM / FWTM 11.0° / 25.0°
 Efficiency 84 %
 Peak intensity 12 cd/lm
 LEDs/each optic 1
 Light colour White
 Required components:

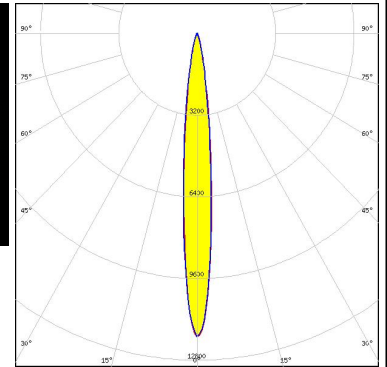
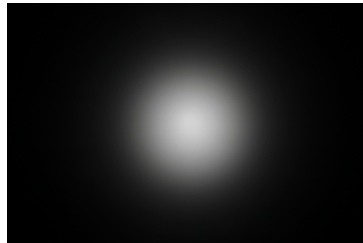

PHOTOMETRIC DATA (MEASURED):

LUMILEDS

LED LUXEON C
 FWHM / FWTM 11.0° / 25.0°
 Efficiency 80 %
 Peak intensity 11 cd/lm
 LEDs/each optic 1
 Light colour White
 Required components:

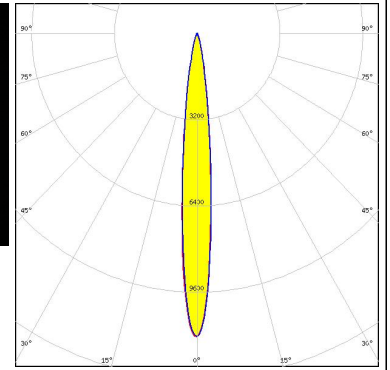

LUMILEDS

LED LUXEON CZ
 FWHM / FWTM 12.0° / 28.0°
 Efficiency 86 %
 Peak intensity 10.8 cd/lm
 LEDs/each optic 1
 Light colour White
 Required components:

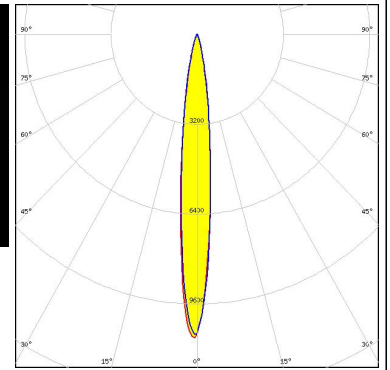
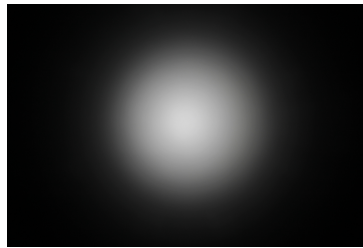

LUMILEDS

LED LUXEON V
 FWHM / FWTM 18.0° / 41.0°
 Efficiency 83 %
 Peak intensity 4.7 cd/lm
 LEDs/each optic 1
 Light colour White
 Required components:

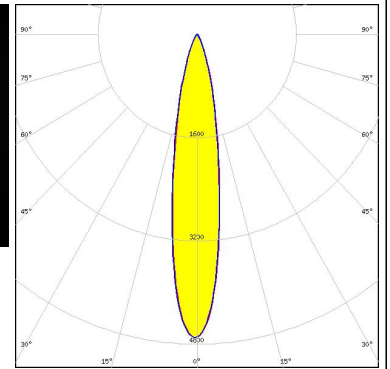

LUMILEDS

LED LUXEON Z ES
 FWHM / FWTM 14.0° / 31.0°
 Efficiency 83 %
 Peak intensity 8.7 cd/lm
 LEDs/each optic 1
 Light colour White
 Required components:

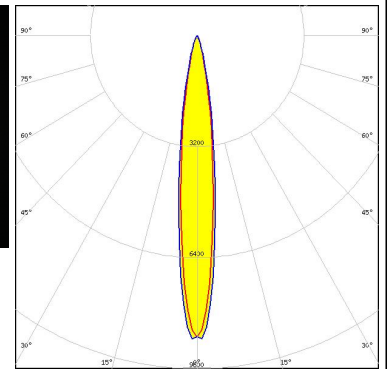

PHOTOMETRIC DATA (MEASURED):



LED NCSxx19A
 FWHM / FWTM 13.0° / 30.0°
 Efficiency 86 %
 Peak intensity 9 cd/lm
 LEDs/each optic 1
 Light colour White
 Required components:

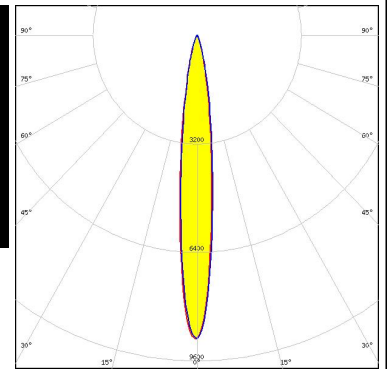

LED NF2x757G
 FWHM / FWTM 16.0° / 37.0°
 Efficiency 88 %
 Peak intensity 6.5 cd/lm
 LEDs/each optic 1
 Light colour White
 Required components:

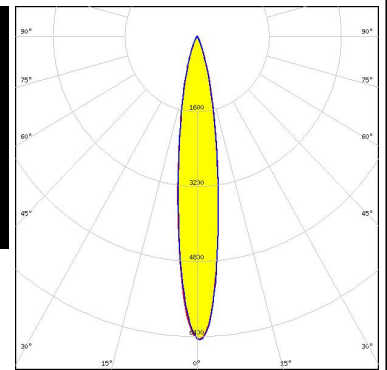
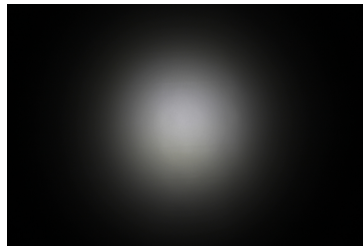

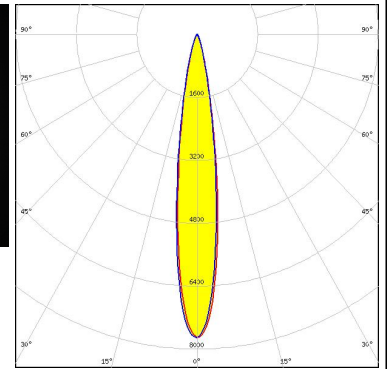

LED NVSW219F
 FWHM / FWTM 15.0° / 32.0°
 Efficiency 87 %
 Peak intensity 7.7 cd/lm
 LEDs/each optic 1
 Light colour White
 Required components:



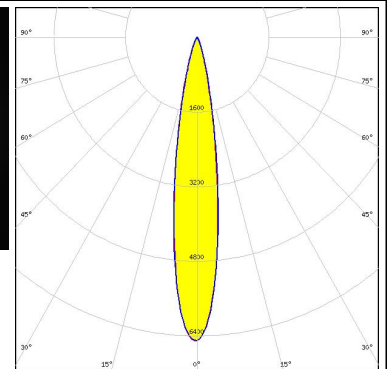

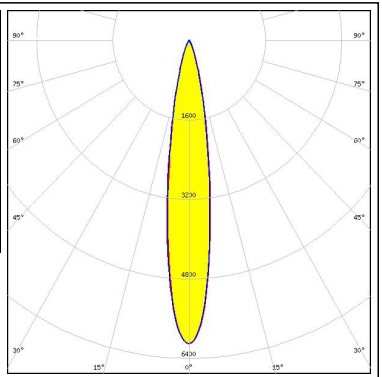
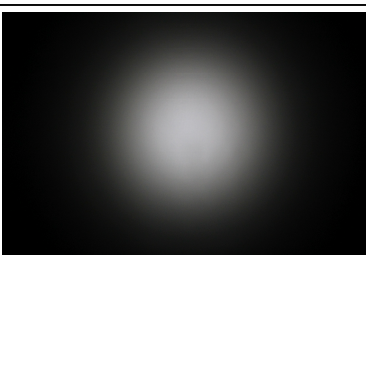
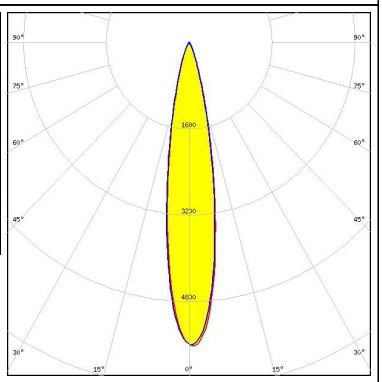
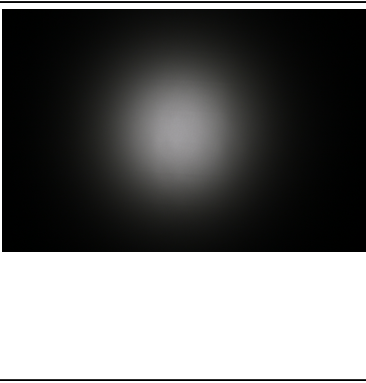
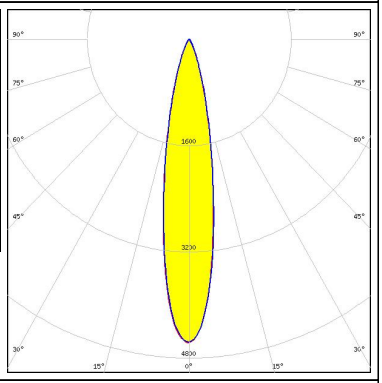

LED NVSW319B
 FWHM / FWTM 17.0° / 35.0°
 Efficiency 87 %
 Peak intensity 6.5 cd/lm
 LEDs/each optic 1
 Light colour White
 Required components:

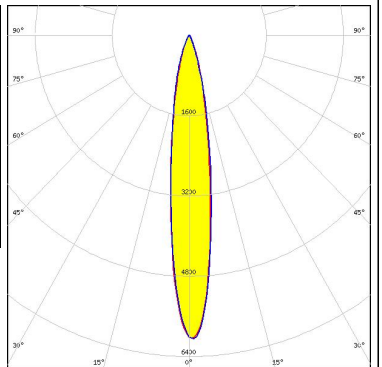

PHOTOMETRIC DATA (MEASURED):

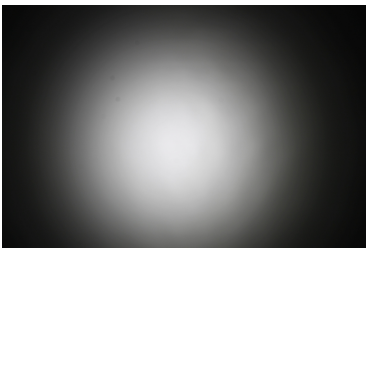
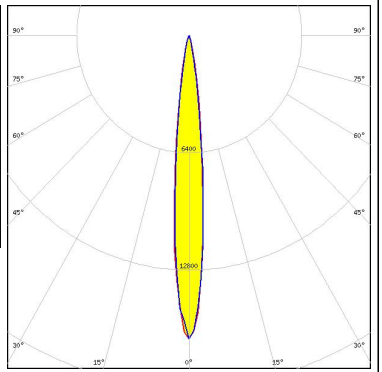
<p>NICHIA</p> <p>LED NVSW3x9A FWHM / FWTM 17.0° / 36.0° Efficiency 81 % Peak intensity 6.1 cd/m² LEDs/each optic 1 Light colour White Required components:</p>		
<p>NICHIA</p> <p>LED NVSW519A FWHM / FWTM 19.0° / 38.0° Efficiency 86 % Peak intensity 5.6 cd/m² LEDs/each optic 1 Light colour White Required components:</p>		
<p>NICHIA</p> <p>LED NWSx229A FWHM / FWTM 29.0° / 42.0° Efficiency 83 % Peak intensity 4.6 cd/m² LEDs/each optic 1 Light colour White Required components:</p>		
<p>OSRAM <small>Opto Semiconductors</small></p> <p>LED Duris S5 (Single chip) FWHM / FWTM 16.0° / 38.0° Efficiency 86 % Peak intensity 6.1 cd/m² LEDs/each optic 1 Light colour White Required components:</p>		

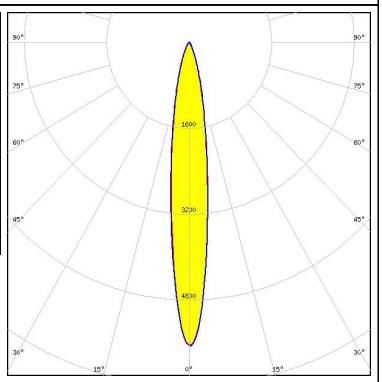
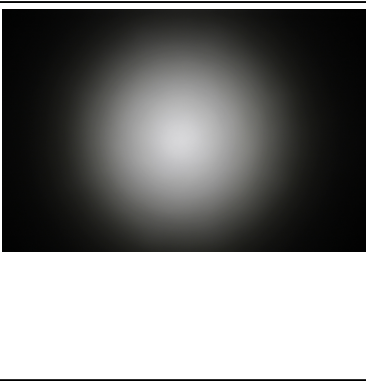
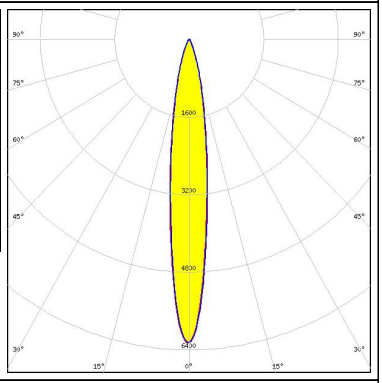
PHOTOMETRIC DATA (MEASURED):

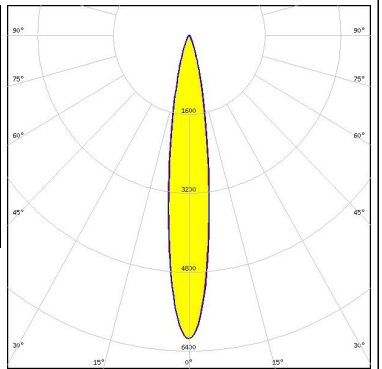
<p>OSRAM Opto Semiconductors</p> <p>LED OSLON Square CSSRM2/CSSRM3</p> <p>FWHM / FWTM 14.0° / 31.0°</p> <p>Efficiency 88 %</p> <p>Peak intensity 8.7 cd/m</p> <p>LEDs/each optic 1</p> <p>Light colour White</p> <p>Required components:</p>		
<p>SAMSUNG</p> <p>LED LH181A</p> <p>FWHM / FWTM 15.0° / 37.0°</p> <p>Efficiency 78 %</p> <p>Peak intensity 5.7 cd/m</p> <p>LEDs/each optic 1</p> <p>Light colour White</p> <p>Required components:</p>		
<p>SAMSUNG</p> <p>LED LH181B</p> <p>FWHM / FWTM 15.0° / 37.0°</p> <p>Efficiency 82 %</p> <p>Peak intensity 6.3 cd/m</p> <p>LEDs/each optic 1</p> <p>Light colour White</p> <p>Required components:</p>		
<p>SEOUL SEMICONDUCTOR</p> <p>LED Z5M3</p> <p>FWHM / FWTM 16.0° / 36.0°</p> <p>Efficiency 84 %</p> <p>Peak intensity 6.2 cd/m</p> <p>LEDs/each optic 1</p> <p>Light colour White</p> <p>Required components:</p>		

PHOTOMETRIC DATA (MEASURED):

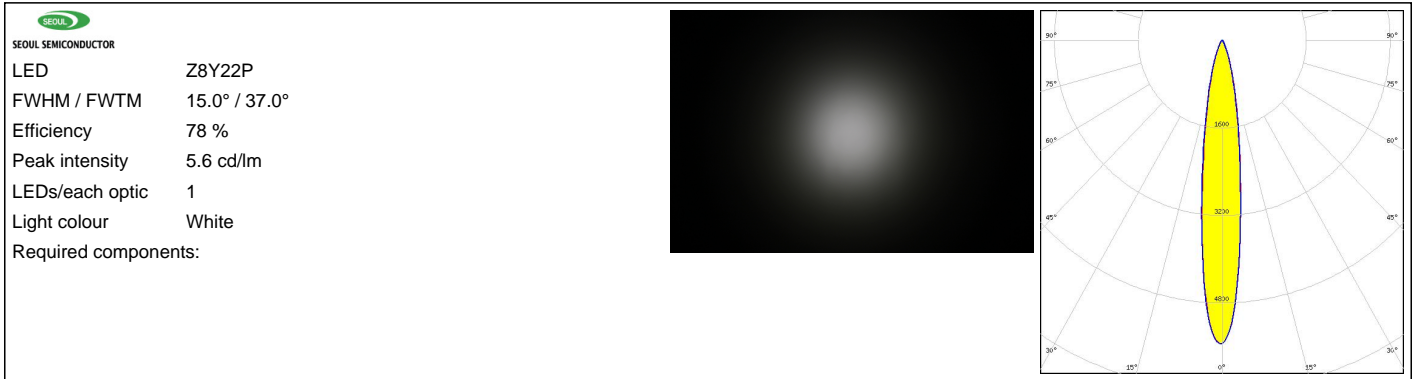

PHOTOMETRIC DATA (SIMULATED):



LED J Series 2835
 FWHM / FWTM 12.0° / 26.0°
 Efficiency 93 %
 Peak intensity 13.3 cd/lm
 LEDs/each optic 1
 Light colour White
 Required components:

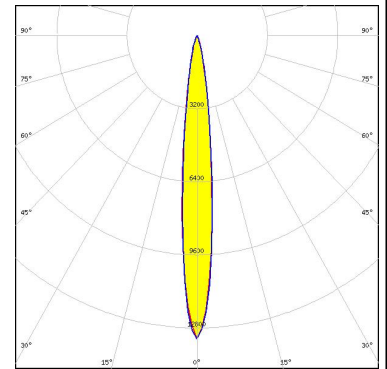

LED XP-G2
 FWHM / FWTM 10.0° / 19.0°
 Efficiency 94 %
 Peak intensity 24.2 cd/lm
 LEDs/each optic 1
 Light colour White
 Required components:

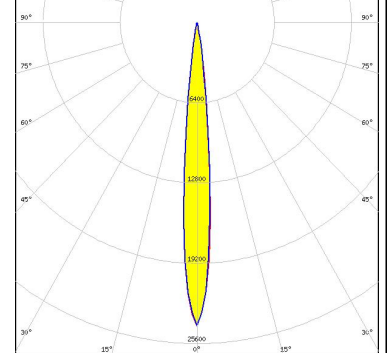

LED XP-G2 HE
 FWHM / FWTM 14.0° / 28.0°
 Efficiency 91 %
 Peak intensity 11.5 cd/lm
 LEDs/each optic 1
 Light colour White
 Required components:

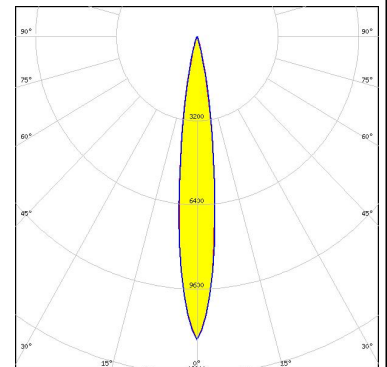

LED XP-G3
 FWHM / FWTM 14.0° / 27.0°
 Efficiency 91 %
 Peak intensity 11.9 cd/lm
 LEDs/each optic 1
 Light colour White
 Required components:

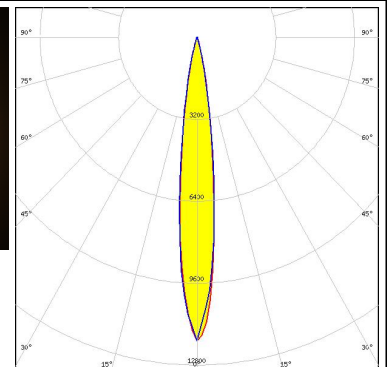
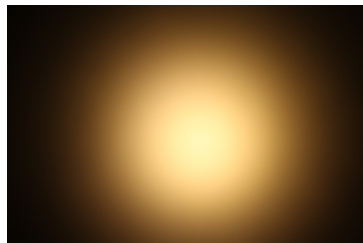

PHOTOMETRIC DATA (SIMULATED):



LED XP-P
 FWHM / FWTM 8.0° / 18.0°
 Efficiency 93 %
 Peak intensity 30 cd/lm
 LEDs/each optic 1
 Light colour White
 Required components:

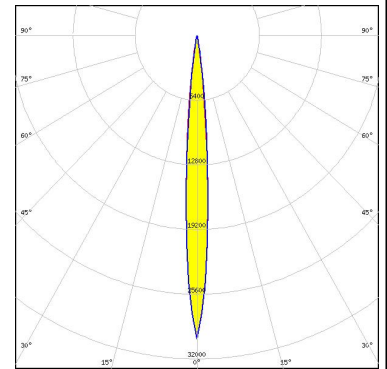

LED XT-E
 FWHM / FWTM 11.0° / 23.0°
 Efficiency 90 %
 Peak intensity 16 cd/lm
 LEDs/each optic 1
 Light colour White
 Required components:

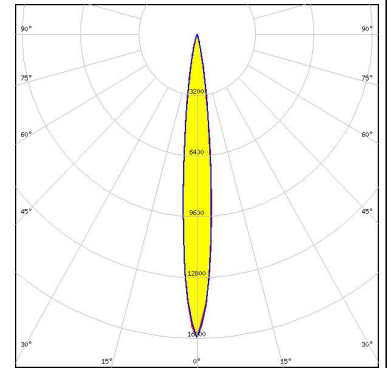

LED LUXEON HL2X
 FWHM / FWTM 14.0° / 26.0°
 Efficiency 93 %
 Peak intensity 13.5 cd/lm
 LEDs/each optic 1
 Light colour White
 Required components:

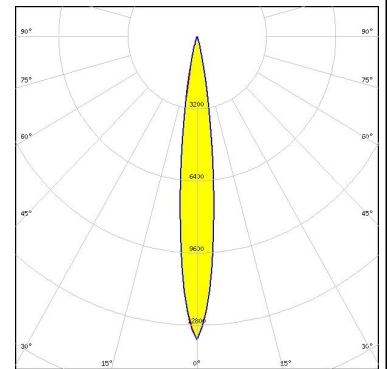

LED LUXEON IR Compact
 FWHM / FWTM 8.0° / 17.0°
 Efficiency 84 %
 LEDs/each optic 1
 Light colour White
 Required components:

PHOTOMETRIC DATA (SIMULATED):

<p>LUMILEDS</p> <p>LED: LUXEON T</p> <p>FWHM / FWTM: 12.0° / 24.0°</p> <p>Efficiency: 93 %</p> <p>Peak intensity: 14.3 cd/lm</p> <p>LEDs/each optic: 1</p> <p>Light colour: White</p> <p>Required components:</p>	
<p>LUMILEDS</p> <p>LED: LUXEON TX</p> <p>FWHM / FWTM: 11.0° / 24.0°</p> <p>Efficiency: 92 %</p> <p>Peak intensity: 15.4 cd/lm</p> <p>LEDs/each optic: 1</p> <p>Light colour: White</p> <p>Required components:</p>	
<p>NICHIA</p> <p>LED: NVSxx19B/NVSxx19C</p> <p>FWHM / FWTM: 13.0° / 27.0°</p> <p>Efficiency: 89 %</p> <p>Peak intensity: 12 cd/lm</p> <p>LEDs/each optic: 1</p> <p>Light colour: White</p> <p>Required components:</p>	
<p>OSRAM Opto Semiconductors</p> <p>LED: OSCONIQ P 3030</p> <p>FWHM / FWTM: 10.0° / 22.0°</p> <p>Efficiency: 92 %</p> <p>Peak intensity: 18 cd/lm</p> <p>LEDs/each optic: 1</p> <p>Light colour: Blue</p> <p>Required components:</p>	

PHOTOMETRIC DATA (SIMULATED):

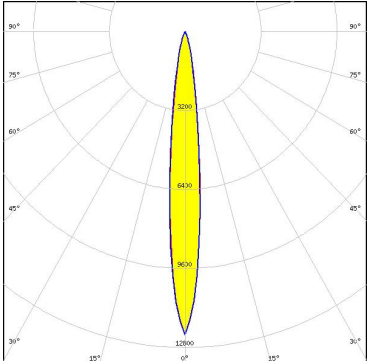
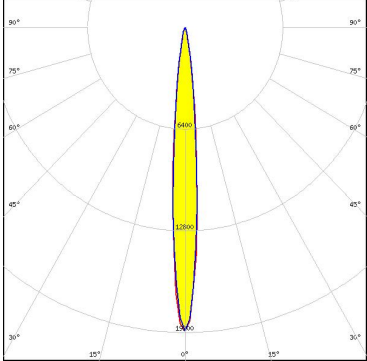
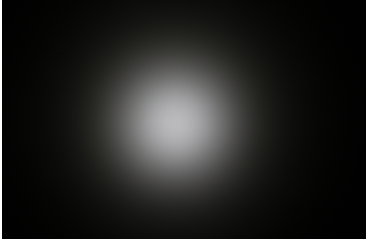
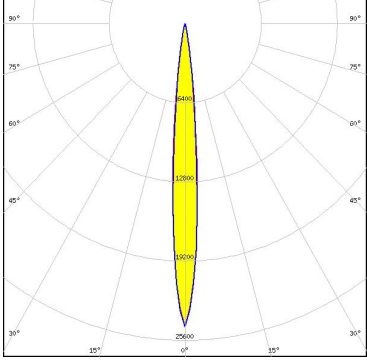
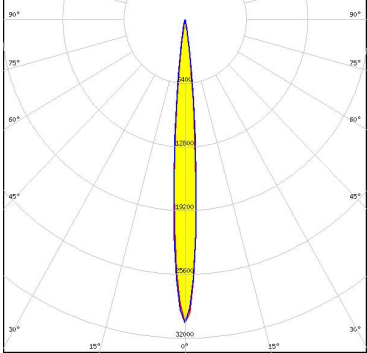
<p>OSRAM Opto Semiconductors</p> <p>LED OSCONIQ P 3737 Flat</p> <p>FWHM / FWTM 12.0° / 28.0°</p> <p>Efficiency 93 %</p> <p>Peak intensity 12.3 cd/lm</p> <p>LEDs/each optic 1</p> <p>Light colour White</p> <p>Required components:</p>	
<p>OSRAM Opto Semiconductors</p> <p>LED OSLON Square Flat</p> <p>FWHM / FWTM 9.4° / 20.0°</p> <p>Efficiency 91 %</p> <p>Peak intensity 19.1 cd/lm</p> <p>LEDs/each optic 1</p> <p>Light colour White</p> <p>Required components:</p>	 
<p>OSRAM Opto Semiconductors</p> <p>LED OSLON SSL 150</p> <p>FWHM / FWTM 10.0° / 19.0°</p> <p>Efficiency 93 %</p> <p>Peak intensity 24.5 cd/lm</p> <p>LEDs/each optic 1</p> <p>Light colour White</p> <p>Required components:</p>	
<p>OSRAM Opto Semiconductors</p> <p>LED OSLON SSL 80</p> <p>FWHM / FWTM 8.3° / 17.0°</p> <p>Efficiency 92 %</p> <p>Peak intensity 30.5 cd/lm</p> <p>LEDs/each optic 1</p> <p>Light colour White</p> <p>Required components:</p>	

PHOTOMETRIC DATA (SIMULATED):

OSRAM

Opto Semiconductors

LED SFH 4715AS
 FWHM / FWTM 11.0° / 24.0°
 Efficiency 92 %
 Peak intensity 15.8 cd/lm
 LEDs/each optic 1
 Light colour IR
 Required components:

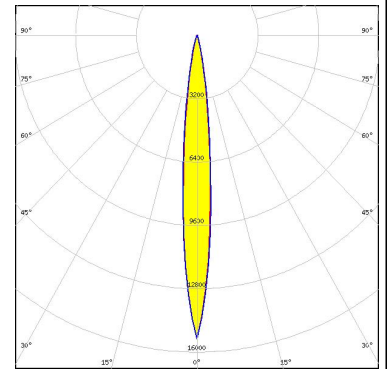

OSRAM

Opto Semiconductors

LED SFH 4770S
 FWHM / FWTM 9.0° / 26.0°
 Efficiency 85 %
 LEDs/each optic 1
 Light colour White
 Required components:

SAMSUNG

LED LH351A
 FWHM / FWTM 11.0° / 23.0°
 Efficiency 91 %
 Peak intensity 15.9 cd/lm
 LEDs/each optic 1
 Light colour White
 Required components:

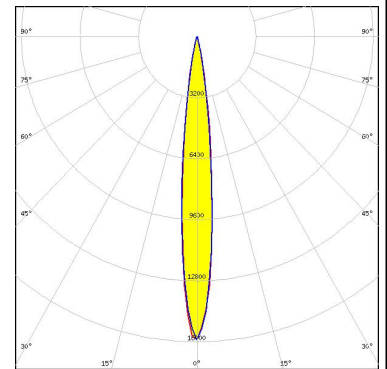

SAMSUNG

LED LH351B
 FWHM / FWTM 12.0° / 26.0°
 Efficiency 92 %
 Peak intensity 13 cd/lm
 LEDs/each optic 1
 Light colour White
 Required components:

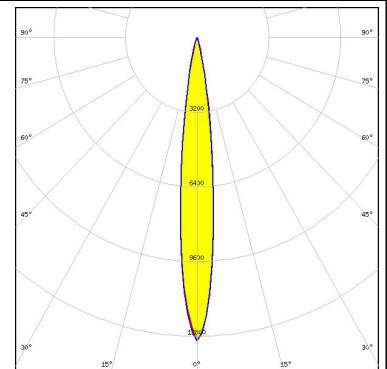

PHOTOMETRIC DATA (SIMULATED):

<p>SEOL SEOUL SEMICONDUCTOR</p> <p>LED Z5M1/Z5M2 FWHM / FWTM 12.0° / 23.0° Efficiency 93 % Peak intensity 15.2 cd/lm LEDs/each optic 1 Light colour White Required components:</p>	
<p>SEOL SEOUL SEMICONDUCTOR</p> <p>LED Z5M4 FWHM / FWTM 13.0° / 30.0° Efficiency 94 % Peak intensity 11.1 cd/lm LEDs/each optic 1 Light colour White Required components:</p>	
<p>SEOL SEOUL SEMICONDUCTOR</p> <p>LED Z5P FWHM / FWTM 10.0° / 22.0° Efficiency 92 % Peak intensity 17.5 cd/lm LEDs/each optic 1 Light colour White Required components:</p>	

GENERAL INFORMATION:

NOTE: The typical beam angle will be changed by different color, chip size and chip position tolerance. The typical total beam angle is the full angle measured where the luminous intensity is half of the peak value.

MATERIALS:

As part of our continuous research and improvement processes, and to ensure the best possible quality and availability of our products, LEDiL reserves the right to change material grades without notice.

PRODUCT DATA USER AGREEMENT AND DISCLAIMER:

The measured data in the provided downloadable LEDiL Product Datasheets and Mechanical 2D-Drawings is rounded and provided as reference for planning. LEDiL Oy's optical specifications have been verified by conducting performance testing of the products in accordance with the company's quality system. The reported data are averaged results of multiple measurements with typical variation. LEDiL Oy reserves the right to without prior notification make changes and improvements to its products.

LEDiL Oy assumes neither warranty, nor guarantee nor any other liability of any kind for the contents and correctness of the provided data. The provided data has been generated with highest diligence but the provided data may in reality not represent the complete possible variation range of all intrinsic parameters. Therefore, in certain cases a deviation from the provided data could occur.

LEDiL Oy reserves the right to undertake technical changes of its products without further notification which could lead to changes in the provided data. LEDiL Oy assumes no liability of any kind for the possible deviation from any provided data or any other damage resulting from the usage of the provided data.

The user agrees to this disclaimer and user agreement with the download or usage of the provided files.

LEDiL Oy

Joensuunkatu 13
FI-24240 SALO
Finland

LEDiL Inc.

228 West Page Street
Suite D
Sycamore IL 60178
USA

Ledil Optics Technology (Shenzhen) Co., Ltd.

405 , Block B
Casic Motor Building
Shenzhen 518057
P.R.CHINA

Local sales and technical support

[www.ledil.com/
where_to_buy](http://www.ledil.com/where_to_buy)

Shipping locations

Salo, Finland
Hong Kong, China

Distribution Partners

[www.ledil.com/
where_to_buy](http://www.ledil.com/where_to_buy)

X-ON Electronics

Largest Supplier of Electrical and Electronic Components

Click to view similar products for [LED Lighting Lenses Assemblies](#) category:

Click to view products by [Ledil](#) manufacturer:

Other Similar products are found below :

[FCN12592_LE1-D-COP](#) [CA16129_OLGA-W](#) [CA16370_HB-SQ-W](#) [FN15972_RONDA-ZT45-C](#) [CS15759_HB-2X2MX-8-W](#)
[CA16435_LXP2-SS-WAS](#) [CN16210_GABRIELLA-MIDI-W](#) [CP17137_CARMEN-M2-C](#) [CA16015_STRADA-SQ-SCL](#) [CP17594_TINA-SC-](#)
[RS](#) [CS15767_HB-2X2MX-8-M](#) [CP10960_RGBX-SS](#) [CP12395_LXP3-W](#) [CP12939_LARISA-RS-CLIP16](#) [C14636_XTM-PF-ADAPTER](#)
[CA11819_STRADA-SQ-T-DW](#) [CA14508_G2-LXP2-D](#) [CA14601_VERONICA-SQ-MINI-RS](#) [FCP13895_SEANNA-A](#) [CP12943_LARISA-](#)
[O-CLIP16](#) [FP11124_LISA2-O-PIN](#) [CS14597_HB-IP-2X6-O](#) [CP14995_FLORENTINA-HLD-O](#) [CS15158_STRADA-IP-2X6-T4-B](#)
[CS16323_STRADELLA-IP-28-HB-M](#) [FN14976_STELLA-DWC2](#) [FN15264_STELLA-HB-WWW](#) [CA15584_ZORYA-MINI-TAPE](#)
[FA15229_ROSE-MRK-S](#) [FA15232_ROSE-MRK-M](#) [FA15233_ROSE-MRK-W](#) [FCN13552_CRYSTAL-RS](#) [FN15552_RONDA-W](#)
[FS15626_FLORENCE-3R-IP-Z90](#) [FS15786_FLORENCE-3R-IP-Z60](#) [FS15847_FLORENCE-3R-IP-O](#) [CA14505_G2-LXP2-RS2-P](#)
[FCN12775_IRIS-O](#) [CP15304_LARISA-RS-PIN](#) [FN15679_RONDA-S](#) [CA15519_VERONICA-SQ-MINI-D](#) [FP14414_LISA2-O-PIN](#)
[LL01CR-DF60L06-M2](#) [FN15993_RONDA-O](#) [FN15977_RONDA-WAS2](#) [CA14366_FLARE-MAXI-TAPE](#) [CA14442_VERONICA-SQ-W](#)
[CA14509_G2-LXP2-M-P](#) [CA15231_VERONICA-SQ-MINI-W](#) [FP11002_LISA2-W-PIN](#)