

VERONICA-SQ-MINI-RS

~17° spot beam

TECHNICAL SPECIFICATIONS:

Dimensions	13.9 x 13.9 mm
Height	8.9 mm
Fastening	tape, pin
ROHS compliant	yes ⓘ

MATERIAL SPECIFICATIONS:

Component	Type	Material	Colour	Finish
VERONICA-SQ-MINI-RS	Single lens	PMMA	clear	
VERONICA-SQ-MINI-TAPE	Tape	Acrylic foam	clear	



ORDERING INFORMATION:

Component	Type	Qty in box	MOQ	MPQ	Box weight (kg)
CA14601_VERONICA-SQ-MINI-RS » Box size: 480 x 280 x 300 mm	Single lens	5544	252	252	7.9

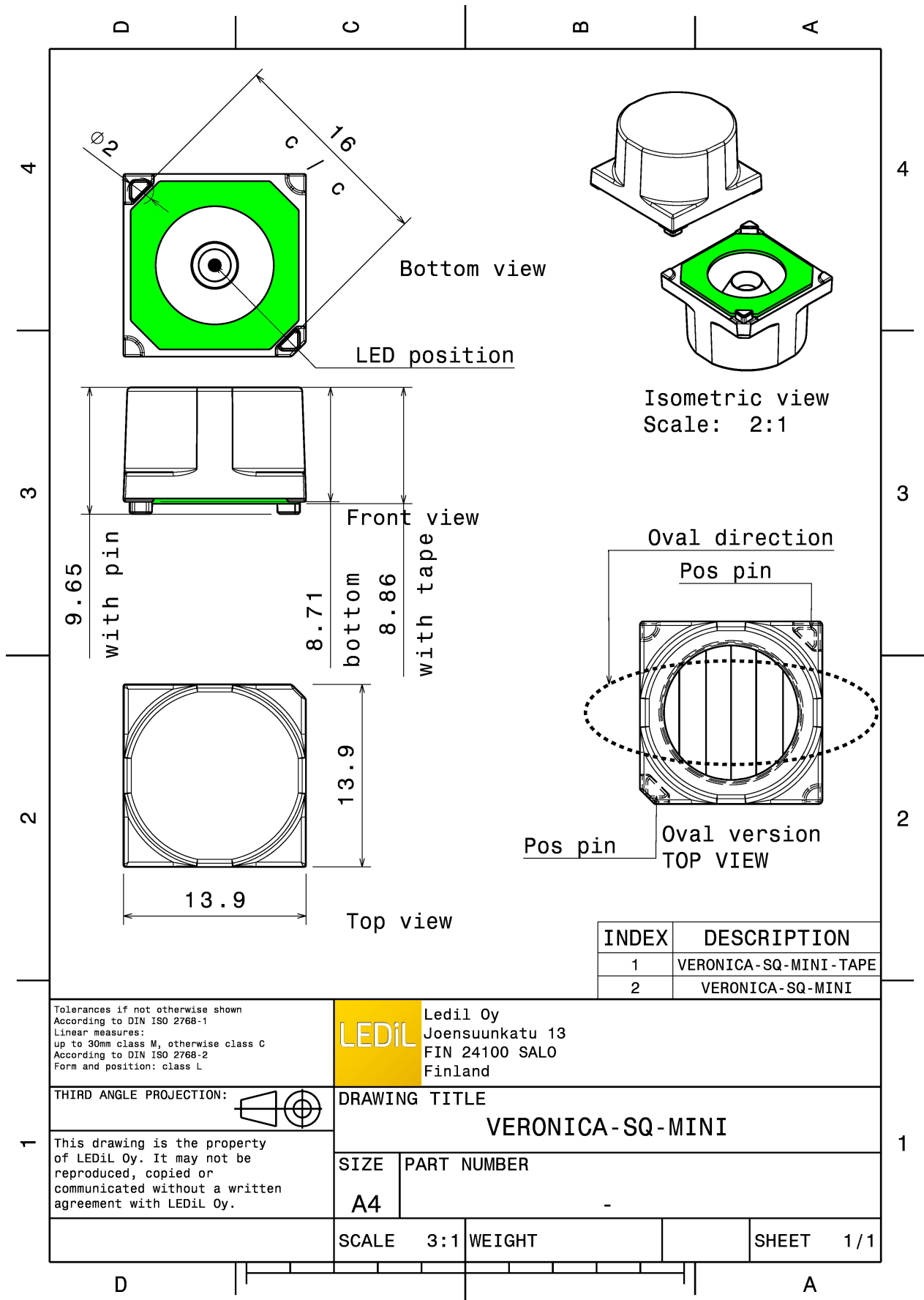

See also our general installation guide: www.ledil.com/installation_guide

PHOTOMETRIC DATA (MEASURED):

CREE LED

LED XD16
 FWHM / FWTM 19.0° / 36.0°
 Efficiency 92 %
 Peak intensity 4.6 cd/lm
 LEDs/each optic 1
 Light colour White
 Required components:

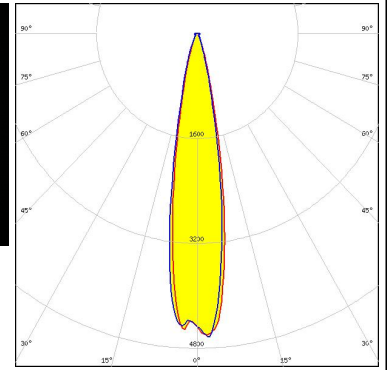

CREE LED

LED XP-E2
 FWHM / FWTM 14.0° / 26.0°
 Efficiency 92 %
 Peak intensity 11 cd/lm
 LEDs/each optic 1
 Light colour White
 Required components:

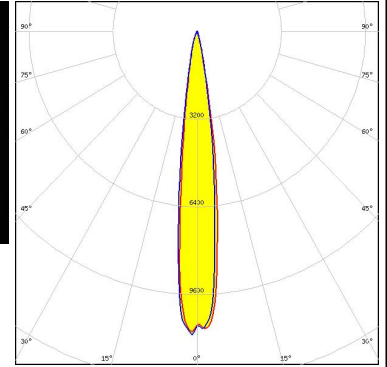

CREE LED

LED XQ-E HI
 FWHM / FWTM 9.4° / 24.0°
 Efficiency 90 %
 Peak intensity 14.7 cd/lm
 LEDs/each optic 1
 Light colour White
 Required components:

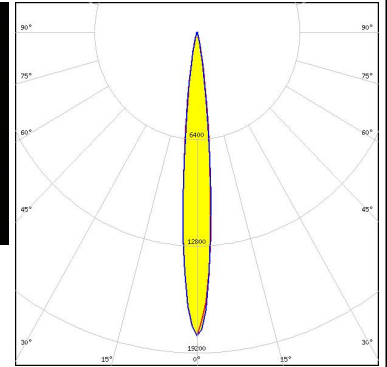





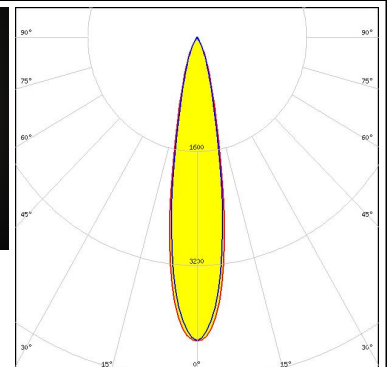
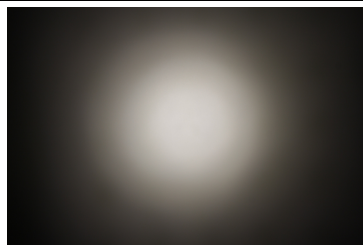

LUMILEDS

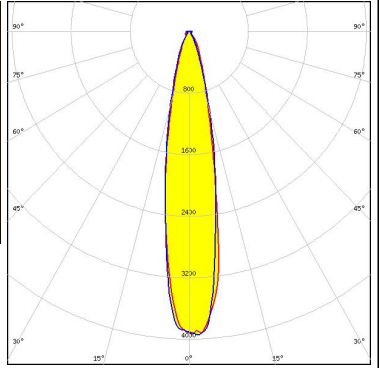
LED LUXEON Rebel ES
 FWHM / FWTM 21.0° / 43.0°
 Efficiency 83 %
 Peak intensity 4.3 cd/lm
 LEDs/each optic 1
 Light colour White
 Required components:

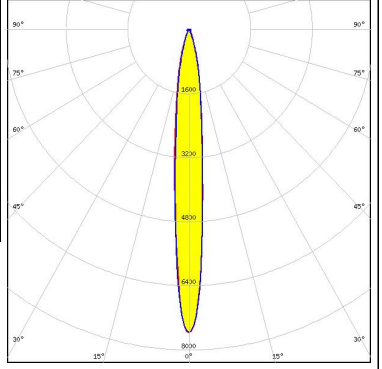

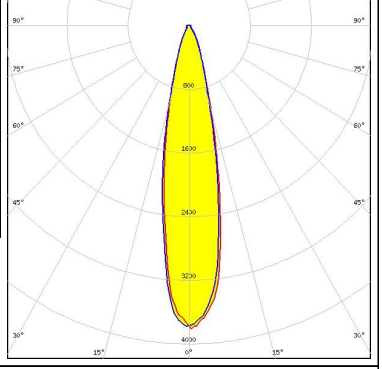
PHOTOMETRIC DATA (MEASURED):

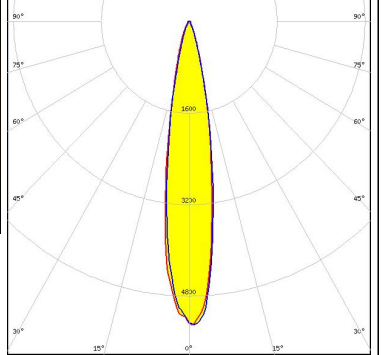
<p>LUMILEDS</p> <p>LED LUXEON TX FWHM / FWTM 20.0° / 44.0° Efficiency 92 % Peak intensity 4 cd/lm LEDs/each optic 1 Light colour White Required components:</p>		
<p>NICHIA</p> <p>LED NCSxE17A FWHM / FWTM 11.0° / 32.0° Efficiency 92 % Peak intensity 7.6 cd/lm LEDs/each optic 1 Light colour White Required components:</p>		
<p>NICHIA</p> <p>LED NVSxx19B/NVSxx19C FWHM / FWTM 21.0° / 45.0° Efficiency 93 % Peak intensity 3.8 cd/lm LEDs/each optic 1 Light colour White Required components:</p>		
<p>OSRAM <small>Opto Semiconductors</small></p> <p>LED OSLON Square EC FWHM / FWTM 18.0° / 37.0° Efficiency 91 % Peak intensity 5.3 cd/lm LEDs/each optic 1 Light colour White Required components:</p>		

PHOTOMETRIC DATA (MEASURED):

OSRAM

Opto Semiconductors

LED SFH 4170S
 FWHM / FWTM 13.0° / 25.0°
 Efficiency %
 LEDs/each optic 1
 Light colour IR
 Required components:

OSRAM

Opto Semiconductors

LED SFH 4180S
 FWHM / FWTM 11.0° / 22.0°
 Efficiency %
 LEDs/each optic 1
 Light colour IR
 Required components:

SAMSUNG

LED LH181A
 FWHM / FWTM 21.0° / 44.0°
 Efficiency 86 %
 Peak intensity 3 cd/lm
 LEDs/each optic 1
 Light colour White
 Required components:

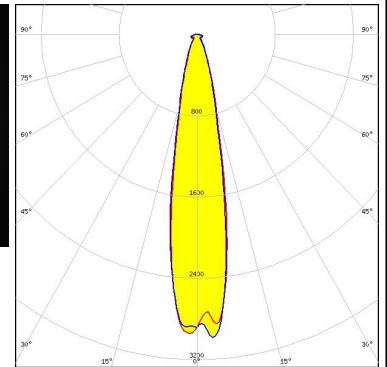

SAMSUNG

LED LH181B
 FWHM / FWTM 22.0° / 45.0°
 Efficiency 94 %
 Peak intensity 3.5 cd/lm
 LEDs/each optic 1
 Light colour White
 Required components:

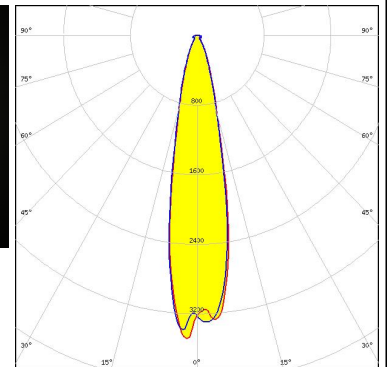

PHOTOMETRIC DATA (MEASURED):



PHOTOMETRIC DATA (SIMULATED):



LED XP-E
 FWHM / FWTM 15.0° / 29.0°
 Efficiency 92 %
 Peak intensity 10.3 cd/lm
 LEDs/each optic 1
 Light colour White
 Required components:

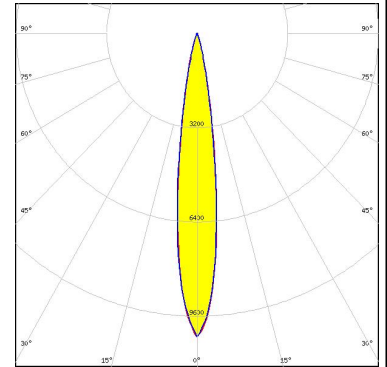

LED XP-G
 FWHM / FWTM 21.0° / 40.0°
 Efficiency 91 %
 Peak intensity 5.2 cd/lm
 LEDs/each optic 1
 Light colour White
 Required components:

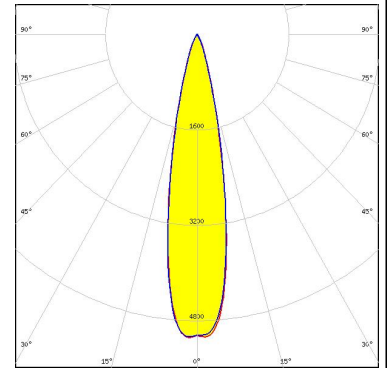

LED XP-G2
 FWHM / FWTM 20.0° / 38.0°
 Efficiency 93 %
 Peak intensity 6 cd/lm
 LEDs/each optic 1
 Light colour White
 Required components:

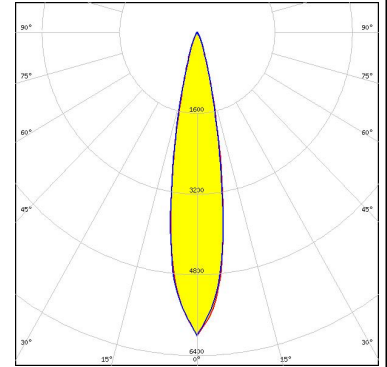

LED XP-G2 HE
 FWHM / FWTM 24.0° / 47.0°
 Efficiency 97 %
 Peak intensity 3.5 cd/lm
 LEDs/each optic 1
 Light colour White
 Required components:

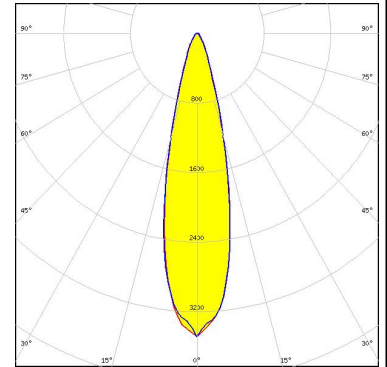

PHOTOMETRIC DATA (SIMULATED):



LED XQ-E HD
 FWHM / FWTM 13.0° / 28.0°
 Efficiency 89 %
 Peak intensity 11 cd/lm
 LEDs/each optic 1
 Light colour White
 Required components:

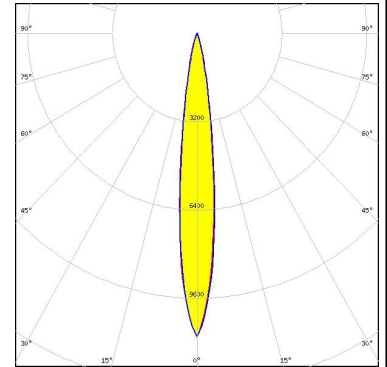

LED LUXEON 2835 Line
 FWHM / FWTM 12.0° / 29.0°
 Efficiency 96 %
 Peak intensity 10 cd/lm
 LEDs/each optic 1
 Light colour PC Amber
 Required components:

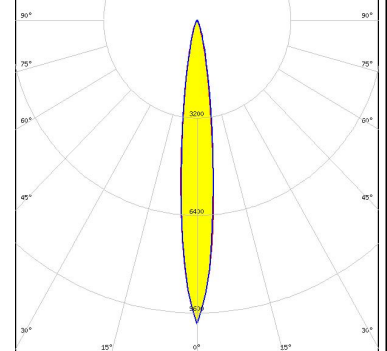

LED LUXEON 3030 2D (Round LES)
 FWHM / FWTM 16.0° / 40.0°
 Efficiency 95 %
 Peak intensity 5.6 cd/lm
 LEDs/each optic 1
 Light colour White
 Required components:

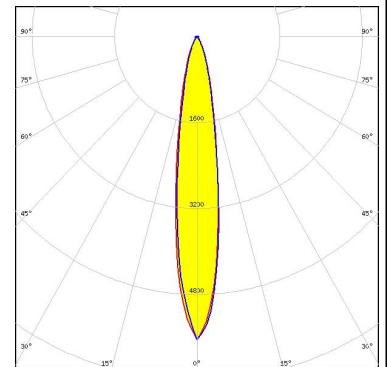

LED LUXEON 3030 HV
 FWHM / FWTM 17.0° / 41.0°
 Efficiency 95 %
 Peak intensity 5.5 cd/lm
 LEDs/each optic 1
 Light colour White
 Required components:

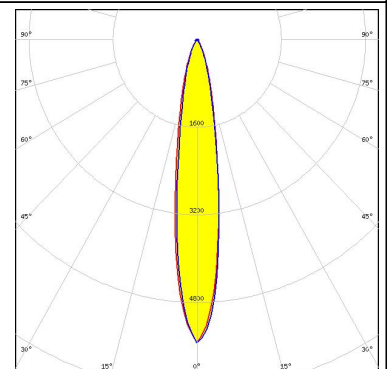

PHOTOMETRIC DATA (SIMULATED):

LUMILEDS

LED LUXEON A
 FWHM / FWTM 21.0° / 42.0°
 Efficiency 89 %
 Peak intensity 4.5 cd/lm
 LEDs/each optic 1
 Light colour White
 Required components:

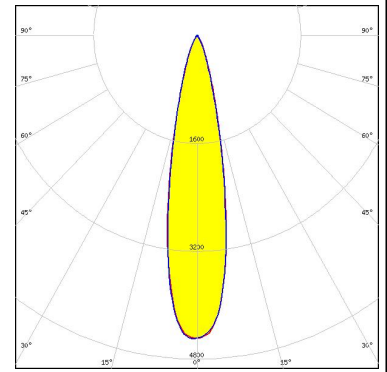

LUMILEDS

LED LUXEON C
 FWHM / FWTM 15.0° / 31.0°
 Efficiency 94 %
 Peak intensity 9.9 cd/lm
 LEDs/each optic 1
 Light colour White
 Required components:

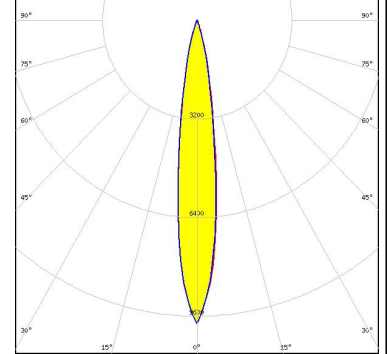

LUMILEDS

LED LUXEON Rebel
 FWHM / FWTM 16.0° / 34.0°
 Efficiency 87 %
 Peak intensity 7.5 cd/lm
 LEDs/each optic 1
 Light colour White
 Required components:

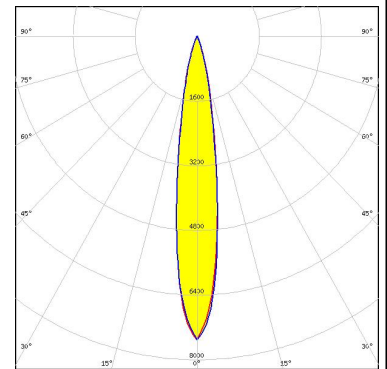

LUMILEDS

LED LUXEON T
 FWHM / FWTM 22.0° / 42.0°
 Efficiency 96 %
 Peak intensity 4.7 cd/lm
 LEDs/each optic 1
 Light colour White
 Required components:

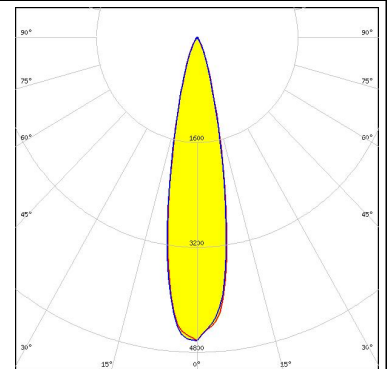

PHOTOMETRIC DATA (SIMULATED):



LED LUXEON Z ES
FWHM / FWTM 14.0° / 31.0°
Efficiency 89 %
Peak intensity 9.5 cd/lm
LEDs/each optic 1
Light colour White
Required components:

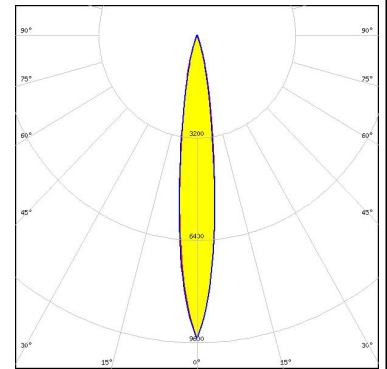

LED NF2x757G
FWHM / FWTM 19.0° / 40.0°
Efficiency 97 %
Peak intensity 5.5 cd/lm
LEDs/each optic 1
Light colour White
Required components:

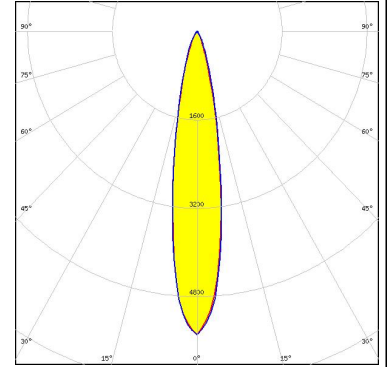

LED NVSxE21A
FWHM / FWTM 15.0° / 41.0°
Efficiency 94 %
Peak intensity 5.3 cd/lm
LEDs/each optic 1
Light colour White
Required components:

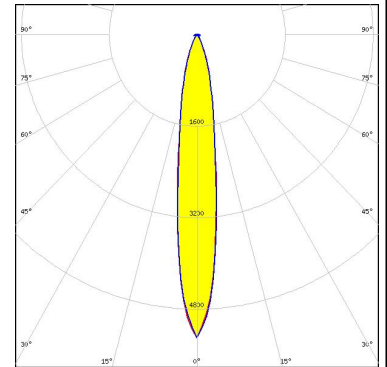

LED OSCONIQ P 3737 (2W version)
FWHM / FWTM 18.0° / 39.0°
Efficiency 94 %
Peak intensity 5.8 cd/lm
LEDs/each optic 1
Light colour White
Required components:

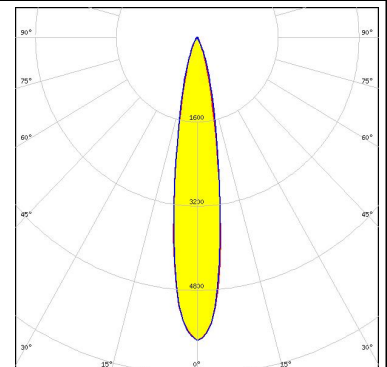

PHOTOMETRIC DATA (SIMULATED):

OSRAM

Opto Semiconductors

LED OSCONIQ P 3737 (3W version)
 FWHM / FWTM 25.0° / 43.0°
 Efficiency 89 %
 Peak intensity 2.6 cd/lm
 LEDs/each optic 1
 Light colour White
 Required components:

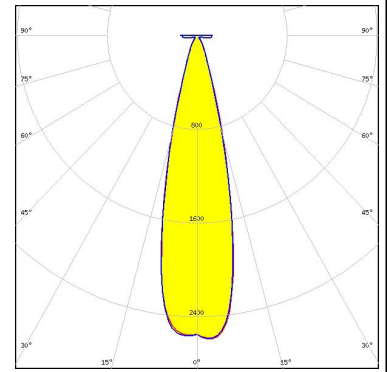

OSRAM

Opto Semiconductors

LED OSLON Square CSSRM2/CSSRM3
 FWHM / FWTM 18.0° / 39.0°
 Efficiency 92 %
 Peak intensity 5.9 cd/lm
 LEDs/each optic 1
 Light colour White
 Required components:

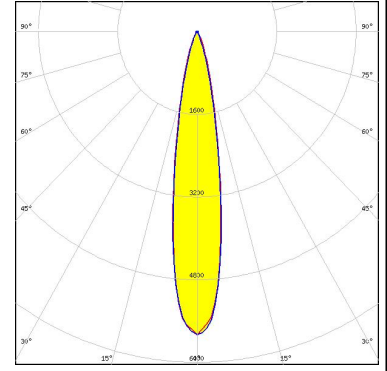

OSRAM

Opto Semiconductors

LED OSLON SSL 150
 FWHM / FWTM 14.0° / 28.0°
 Efficiency 89 %
 Peak intensity 10.7 cd/lm
 LEDs/each optic 1
 Light colour White
 Required components:

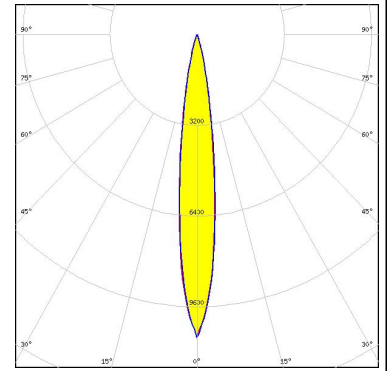

OSRAM

Opto Semiconductors

LED OSLON SSL 80
 FWHM / FWTM 14.0° / 29.0°
 Efficiency 90 %
 Peak intensity 10.2 cd/lm
 LEDs/each optic 1
 Light colour White
 Required components:

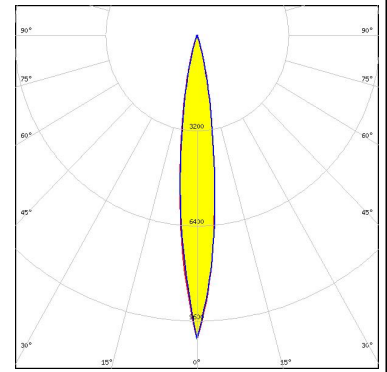

PHOTOMETRIC DATA (SIMULATED):

SAMSUNG

LED LH351B
 FWHM / FWTM 24.0° / 46.0°
 Efficiency 94 %
 Peak intensity 3.9 cd/lm
 LEDs/each optic 1
 Light colour White
 Required components:

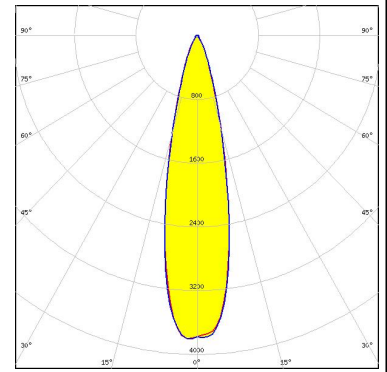

SAMSUNG

LED LH351Z
 FWHM / FWTM 19.0° / 36.0°
 Efficiency 92 %
 Peak intensity 6.1 cd/lm
 LEDs/each optic 1
 Light colour White
 Required components:

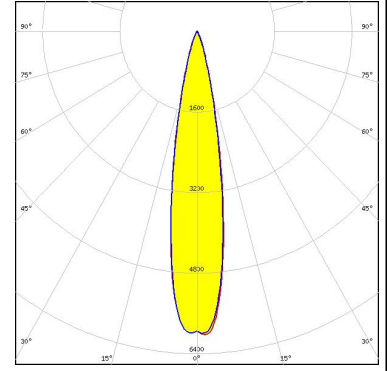

SEOUL SEMICONDUCTOR

LED MJT 3030
 FWHM / FWTM 16.0° / 38.0°
 Efficiency 96 %
 Peak intensity 6.1 cd/lm
 LEDs/each optic 1
 Light colour White
 Required components:

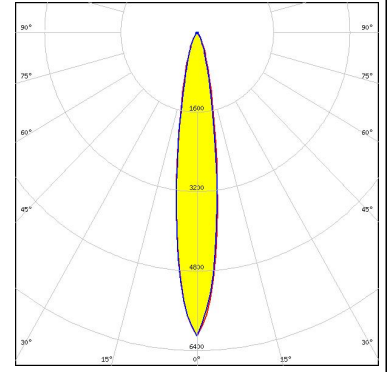

SEOUL SEMICONDUCTOR

LED Z8Y22T
 FWHM / FWTM 19.0° / 50.0°
 Efficiency 94 %
 Peak intensity 3.6 cd/lm
 LEDs/each optic 1
 Light colour White
 Required components:

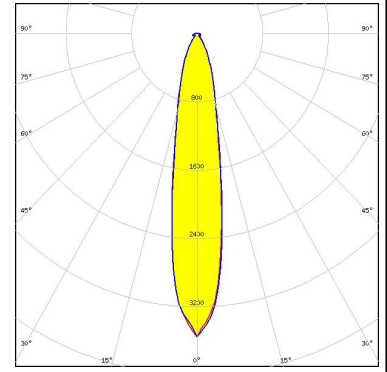

GENERAL INFORMATION:

NOTE: The typical beam angle will be changed by different color, chip size and chip position tolerance. The typical total beam angle is the full angle measured where the luminous intensity is half of the peak value.

MATERIALS:

As part of our continuous research and improvement processes, and to ensure the best possible quality and availability of our products, LEDiL reserves the right to change material grades without notice.

PRODUCT DATA USER AGREEMENT AND DISCLAIMER:

The measured data in the provided downloadable LEDiL Product Datasheets and Mechanical 2D-Drawings is rounded and provided as reference for planning. LEDiL Oy's optical specifications have been verified by conducting performance testing of the products in accordance with the company's quality system. The reported data are averaged results of multiple measurements with typical variation. LEDiL Oy reserves the right to without prior notification make changes and improvements to its products.

LEDiL Oy assumes neither warranty, nor guarantee nor any other liability of any kind for the contents and correctness of the provided data. The provided data has been generated with highest diligence but the provided data may in reality not represent the complete possible variation range of all intrinsic parameters. Therefore, in certain cases a deviation from the provided data could occur.

LEDiL Oy reserves the right to undertake technical changes of its products without further notification which could lead to changes in the provided data. LEDiL Oy assumes no liability of any kind for the possible deviation from any provided data or any other damage resulting from the usage of the provided data.

The user agrees to this disclaimer and user agreement with the download or usage of the provided files.

LEDiL Oy

Joensuunkatu 13
FI-24240 SALO
Finland

LEDiL Inc.

228 West Page Street
Suite D
Sycamore IL 60178
USA

Ledil Optics Technology (Shenzhen) Co., Ltd.

405 , Block B
Casic Motor Building
Shenzhen 518057
P.R.CHINA

Local sales and technical support

[www.ledil.com/
where_to_buy](http://www.ledil.com/where_to_buy)

Shipping locations

Salo, Finland
Hong Kong, China

Distribution Partners

[www.ledil.com/
where_to_buy](http://www.ledil.com/where_to_buy)

X-ON Electronics

Largest Supplier of Electrical and Electronic Components

Click to view similar products for [LED Lighting Lenses Assemblies](#) category:

Click to view products by [Ledil](#) manufacturer:

Other Similar products are found below :

[FCN12592_LE1-D-COP](#) [CA16129_OLGA-W](#) [CA16370_HB-SQ-W](#) [FN15972_RONDA-ZT45-C](#) [CS15759_HB-2X2MX-8-W](#)
[CA16435_LXP2-SS-WAS](#) [CN16210_GABRIELLA-MIDI-W](#) [CP17137_CARMEN-M2-C](#) [CA16015_STRADA-SQ-SCL](#) [CP17594_TINA-SC-](#)
[RS](#) [CS15767_HB-2X2MX-8-M](#) [CP10960_RGBX-SS](#) [CP12395_LXP3-W](#) [CP12939_LARISA-RS-CLIP16](#) [C14636_XTM-PF-ADAPTER](#)
[CA11819_STRADA-SQ-T-DW](#) [CA14506_G2-LXP2-RS2](#) [CA14508_G2-LXP2-D](#) [CA14601_VERONICA-SQ-MINI-RS](#)
[FCP13895_SEANNA-A](#) [FP11124_LISA2-O-PIN](#) [CS14597_HB-IP-2X6-O](#) [CP14995_FLORENTINA-HLD-O](#) [CS15158_STRADA-IP-2X6-](#)
[T4-B](#) [CS16323_STRADELLA-IP-28-HB-M](#) [FN14976_STELLA-DWC2](#) [FN15264_STELLA-HB-WWW](#) [CA15584_ZORYA-MINI-TAPE](#)
[FA15229_ROSE-MRK-S](#) [FA15232_ROSE-MRK-M](#) [FA15233_ROSE-MRK-W](#) [FCN13552_CRYSTAL-RS](#) [FN15552_RONDA-W](#)
[FS15626_FLORENCE-3R-IP-Z90](#) [FS15786_FLORENCE-3R-IP-Z60](#) [FS15847_FLORENCE-3R-IP-O](#) [CA14505_G2-LXP2-RS2-P](#)
[FCN12775_IRIS-O](#) [FCA15007_G2-ROSE-UV-SS](#) [CP15304_LARISA-RS-PIN](#) [FN15679_RONDA-S](#) [CA15519_VERONICA-SQ-MINI-D](#)
[FP14414_LISA2-O-PIN](#) [LL01CR-DF60L06-M2](#) [FN15993_RONDA-O](#) [FN15977_RONDA-WAS2](#) [CA14366_FLARE-MAXI-TAPE](#)
[CA14442_VERONICA-SQ-W](#) [CA14509_G2-LXP2-M-P](#) [CA15231_VERONICA-SQ-MINI-W](#)