

HB-SQ-WWW

~90° beam. Assembly with installation tape.

TECHNICAL SPECIFICATIONS:

Dimensions	25.0 mm
Height	10 mm
Fastening	tape, pin
ROHS compliant	yes 

MATERIAL SPECIFICATIONS:

Component	Type	Material	Colour	Finish
HB-SQ-WWW	Single lens	PMMA	clear	
ROSE-TAPE	Tape	PU tape	black	

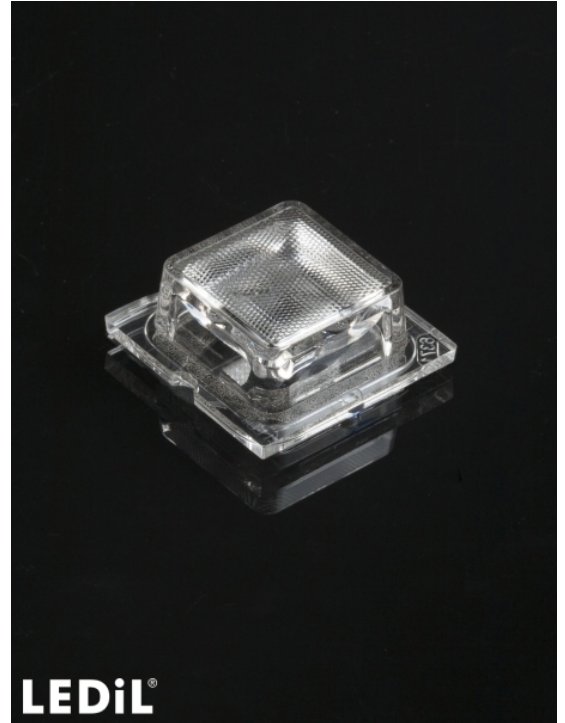

ORDERING INFORMATION:

Component	Type	Qty in box	MOQ	MPQ	Box weight (kg)
CA16372_HB-SQ-WWW » Box size: 480 x 280 x 300 mm	Single lens	2058	294	98	8.9

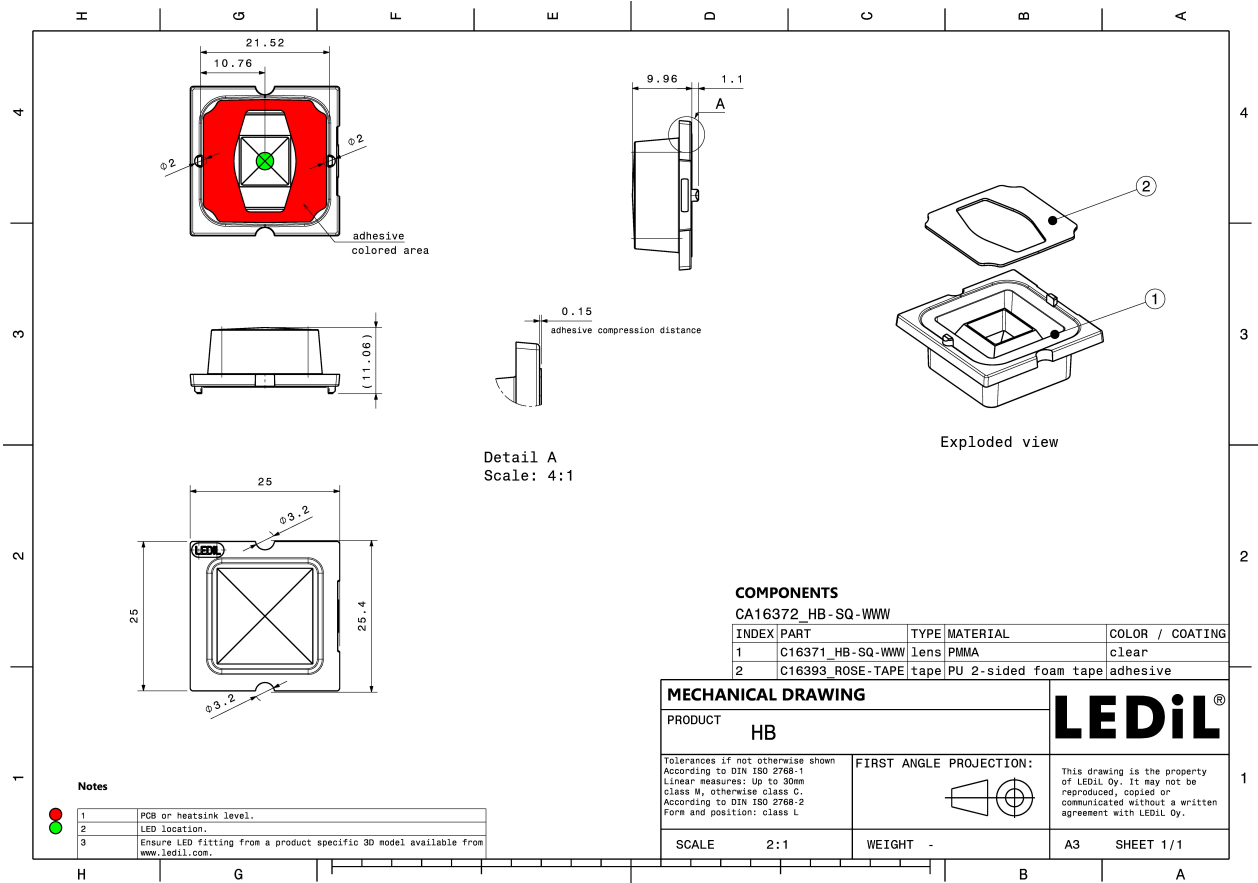

PHOTOMETRIC DATA (MEASURED):





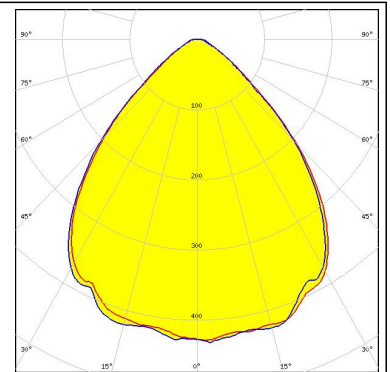
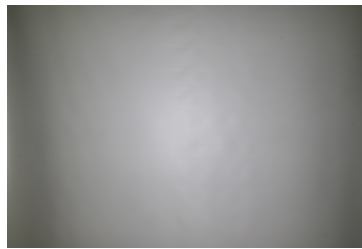

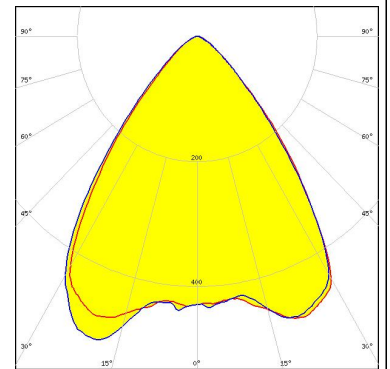
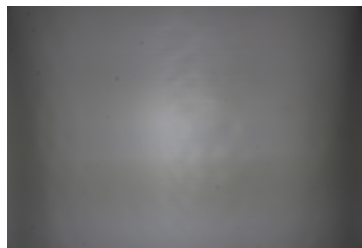

LED XHP70
FWHM 88.0°
Efficiency 91 %
Peak intensity 0.4 cd/lm
LEDs/each optic 1
Light colour White
Required components:

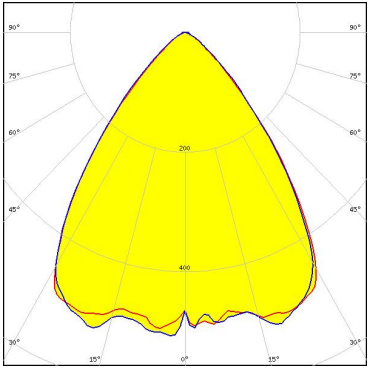

LED LUXEON 5050 Round LES
FWHM 80.0°
Efficiency 93 %
Peak intensity 0.5 cd/lm
LEDs/each optic 1
Light colour White
Required components:

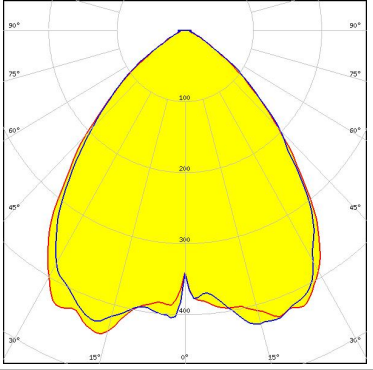

PHOTOMETRIC DATA (SIMULATED):

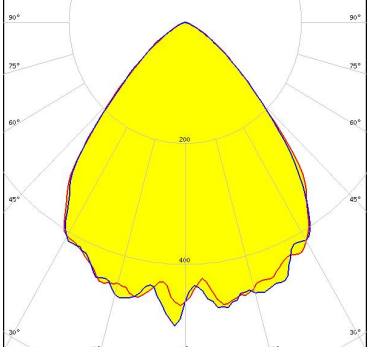
<p> bridgelux</p> <p>LED Bridgelux SMD 5050 FWHM 77.0° Efficiency 93 % Peak intensity 0.5 cd/lm LEDs/each optic 1 Light colour White Required components:</p>	
<p> CREE</p> <p>LED MHD-E/G FWHM 85.5° Efficiency 91 % Peak intensity 0.5 cd/lm LEDs/each optic 1 Light colour White Required components:</p>	
<p> CREE</p> <p>LED XHP50.2 FWHM 86.0° Efficiency 93 % Peak intensity 0.4 cd/lm LEDs/each optic 1 Light colour White Required components:</p>	
<p> CREE</p> <p>LED XHP70 FWHM 83.0° Efficiency 89 % Peak intensity 0.5 cd/lm LEDs/each optic 1 Light colour White Required components:</p>	

PHOTOMETRIC DATA (SIMULATED):



LED XHP70.2
FWHM 85.0°
Efficiency 86 %
Peak intensity 0.4 cd/lm
LEDs/each optic 1
Light colour White
Required components:

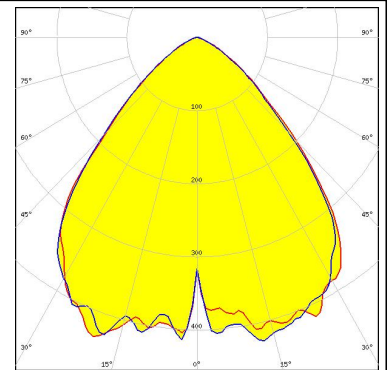

LED LUXEON M/MX
FWHM 80.0°
Efficiency 90 %
Peak intensity 0.6 cd/lm
LEDs/each optic 1
Light colour White
Required components:

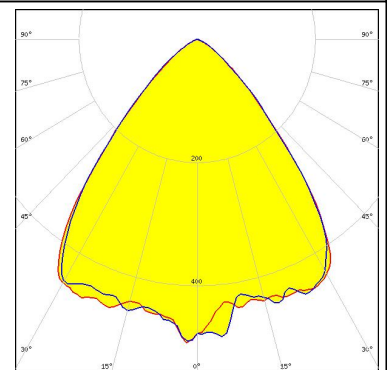

LED LUXEON M/MX
FWHM 88.0°
Efficiency 86 %
Peak intensity 0.4 cd/lm
LEDs/each optic 1
Light colour White
Required components:

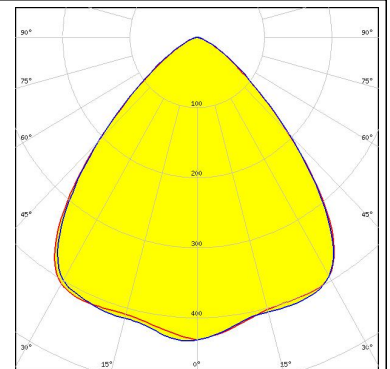

Transparent protective cover



LED LUXEON MZ
FWHM 77.0°
Efficiency 94 %
Peak intensity 0.6 cd/lm
LEDs/each optic 1
Light colour White
Required components:

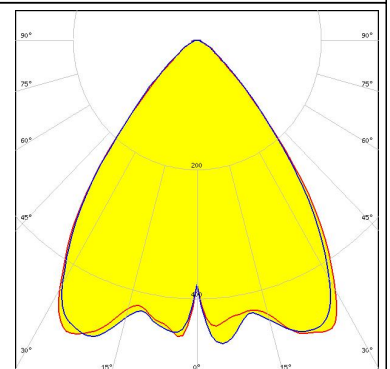

PHOTOMETRIC DATA (SIMULATED):

<p>LUMILEDS</p> <p>LED LUXEON V FWHM 81.0° Efficiency 92 % Peak intensity 0.5 cd/lm LEDs/each optic 1 Light colour White Required components:</p>	
<p>NICHIA</p> <p>LED NV4x144A FWHM 86.0° Efficiency 90 % Peak intensity 0.4 cd/lm LEDs/each optic 1 Light colour White Required components:</p>	
<p>OSRAM Opto Semiconductors</p> <p>LED Duris S10 FWHM 74.0° Efficiency 95 % Peak intensity 0.6 cd/lm LEDs/each optic 1 Light colour White Required components:</p>	
<p>OSRAM Opto Semiconductors</p> <p>LED OSCONIQ P 7070 FWHM 75.0° Efficiency 91 % Peak intensity 0.6 cd/lm LEDs/each optic 1 Light colour White Required components:</p>	

GENERAL INFORMATION:

NOTE: The typical beam angle will be changed by different color, chip size and chip position tolerance. The typical total beam angle is the full angle measured where the luminous intensity is half of the peak value.

MATERIALS:

As part of our continuous research and improvement processes, and to ensure the best possible quality and availability of our products, LEDiL reserves the right to change material grades without notice.

PRODUCT DATA USER AGREEMENT AND DISCLAIMER:

The measured data in the provided downloadable LEDiL Product Datasheets and Mechanical 2D-Drawings is rounded and provided as reference for planning. LEDiL Oy's optical specifications have been verified by conducting performance testing of the products in accordance with the company's quality system. The reported data are averaged results of multiple measurements with typical variation. LEDiL Oy reserves the right to without prior notification make changes and improvements to its products.

LEDiL Oy assumes neither warranty, nor guarantee nor any other liability of any kind for the contents and correctness of the provided data. The provided data has been generated with highest diligence but the provided data may in reality not represent the complete possible variation range of all intrinsic parameters. Therefore, in certain cases a deviation from the provided data could occur.

LEDiL Oy reserves the right to undertake technical changes of its products without further notification which could lead to changes in the provided data. LEDiL Oy assumes no liability of any kind for the possible deviation from any provided data or any other damage resulting from the usage of the provided data.

The user agrees to this disclaimer and user agreement with the download or usage of the provided files.

LEDiL Oy

Joensuunkatu 13
FI-24240 SALO
Finland

LEDiL Inc.

228 West Page Street
Suite D
Sycamore IL 60178
USA

Local sales and technical support

[www.ledil.com/
where_to_buy](http://www.ledil.com/where_to_buy)

Shipping locations

Salo, Finland
Hong Kong, China

Distribution Partners

[www.ledil.com/
where_to_buy](http://www.ledil.com/where_to_buy)

X-ON Electronics

Largest Supplier of Electrical and Electronic Components

Click to view similar products for [LED Lighting Lenses Assemblies](#) category:

Click to view products by [Ledil](#) manufacturer:

Other Similar products are found below :

[FCN12592_LE1-D-COP](#) [CA11362_IRIS](#) [CA16127_OLGA-S](#) [CP16107_CARMEN-50-S-C](#) [CS15763_STRADA-2X2MX-8-VSM](#)
[C17171_DAISSY-8X1-SHD-MATT](#) [C17172_DAISSY-8X1-SHD-MATT-WHT](#) [C17173_DAISSY-4X1-WW-US](#) [C17341_DAISSY-4X1-WW-US-](#)
[D](#) [CS15759_HB-2X2MX-8-W](#) [CS15769_STRADA-2X2MX-8-T2-S](#) [CA16435_LXP2-SS-WAS](#) [CS13756_STRADA-IP-2X6-DWC-PC](#)
[CN16210_GABRIELLA-MIDI-W](#) [CP17138_CARMEN-M2-C-WHT](#) [CP17137_CARMEN-M2-C](#) [CA16015_STRADA-SQ-SCL](#)
[C16989_DAISSY-7X1-W2](#) [C17225_DAISSY-7X1-SHD-WHT-MATT](#) [C17296_ILONA-ZOOM-SUB](#) [FP15752_STRADA-2X2MXS-T3](#)
[C16590_DAISSY-4X1-SHD](#) [FP16562_LISA3-WWW-PIN](#) [CX15819_GABRIELLA-45-W](#) [C16870_DAISSY-7X1-WW](#) [CP12939_LARISA-RS-](#)
[CLIP16](#) [C14636_XTM-PF-ADAPTER](#) [CA14506_G2-LXP2-RS2](#) [CA14508_G2-LXP2-D](#) [FCP13895_SEANNA-A](#) [FN14637_OLIVIA-S](#)
[CP12943_LARISA-O-CLIP16](#) [FP11124_LISA2-O-PIN](#) [CP10444_LISA-SS](#) [CS14597_HB-IP-2X6-O](#) [CP14995_FLORENTINA-HLD-O](#)
[CA16128_OLGA-M](#) [CP14994_FLORENTINA-HLD-M](#) [CP15775_CARMEN-M-C](#) [CS15158_STRADA-IP-2X6-T4-B](#) [CS15363_STRADA-](#)
[IP-2X6-T2-B](#) [CS15751_STRADA-2X2MX-8-DWC](#) [CS15886_STRADA-IP-2X6-T2-B-90](#) [CS16323_STRADELLA-IP-28-HB-M](#)
[FN14976_STELLA-DWC2](#) [FN15264_STELLA-HB-WWW](#) [FN15966_RONDA-WWW-C](#) [FN15971_RONDA-WAS-C](#) [FP15073_ZORYA-](#)
[SC-B](#) [CA15584_ZORYA-MINI-TAPE](#)