

## OLGA-WW

~60° wide beam with flange. Assembly with holder and installation tape.

### TECHNICAL SPECIFICATIONS:

Dimensions	Ø 32.0 mm
Height	19.1 mm
Fastening	tape, pin
ROHS compliant	yes ⓘ

### MATERIAL SPECIFICATIONS:

Component	Type	Material	Colour	Finish
OLGA-WW	Single lens	PMMA		
OLGA-HLD	Holder	PC	black	
SPUTNIK-TAPE3	Tape	Acrylic foam	black	

### ORDERING INFORMATION:

Component	Type	Qty in box	MOQ	MPQ	Box weight (kg)
CA18063_OLGA-WW	Single lens	792	132	66	10.2
» Box size: 476 x 273 x 292 mm					



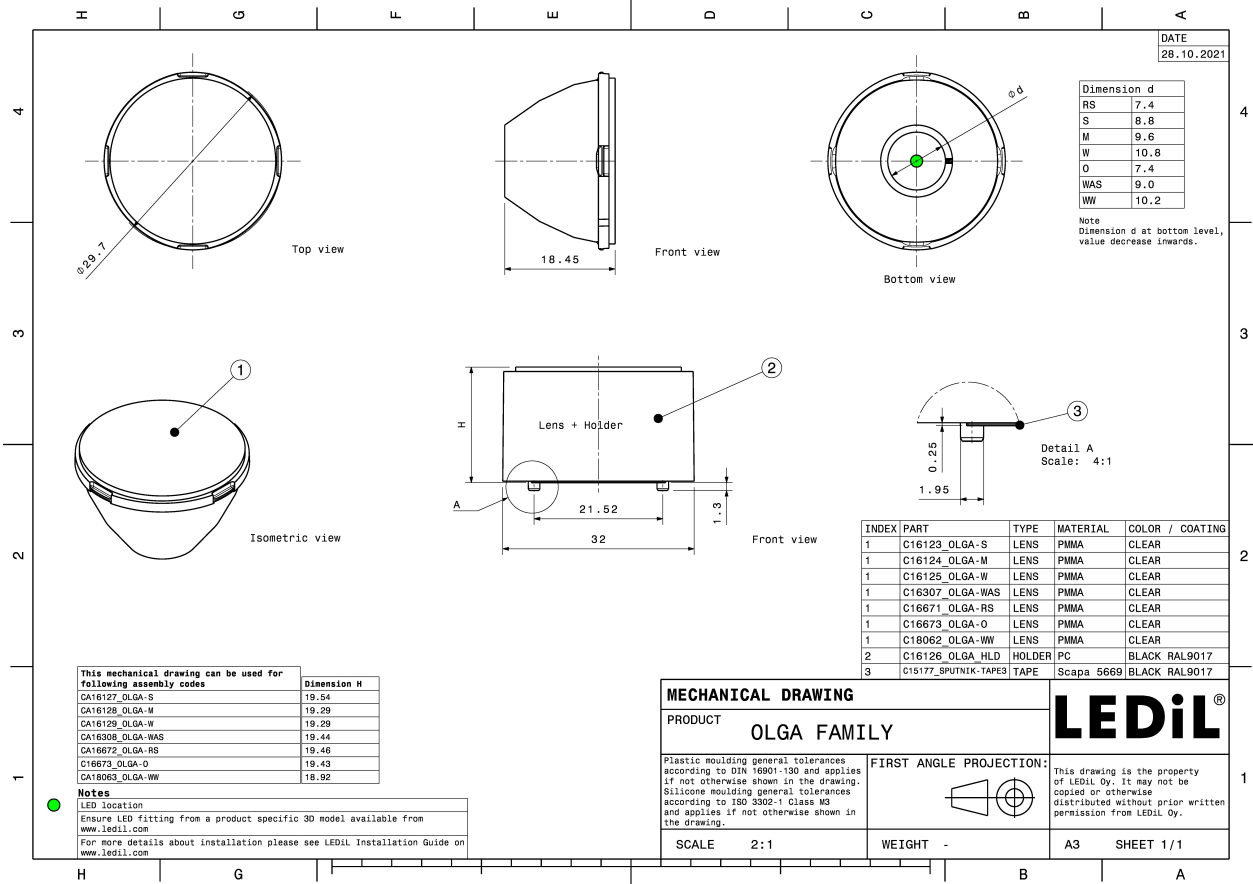

See also our general installation guide: [www.ledil.com/installation\\_guide](http://www.ledil.com/installation_guide)

### PHOTOMETRIC DATA (MEASURED):



LED XHP50.2  
FWHM / FWTM 63.0° / 91.0°  
Efficiency 79 %  
Peak intensity 0.7 cd/lm  
LEDs/each optic 1  
Light colour White  
Required components:

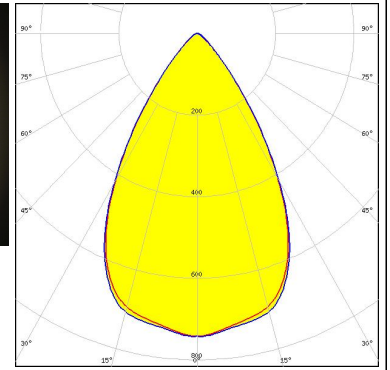
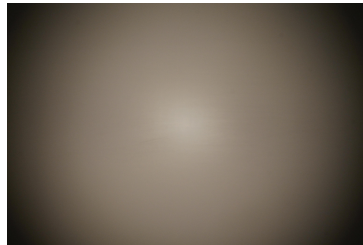

LED LUXEON 5050 Round LES  
FWHM / FWTM 60.0° / 86.0°  
Efficiency 83 %  
Peak intensity 0.9 cd/lm  
LEDs/each optic 1  
Light colour White  
Required components:

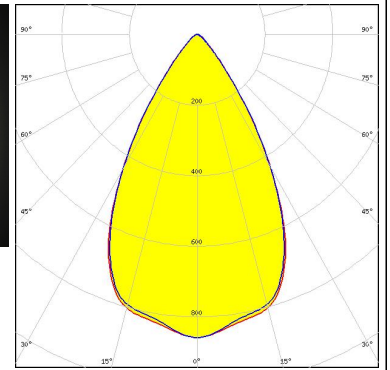
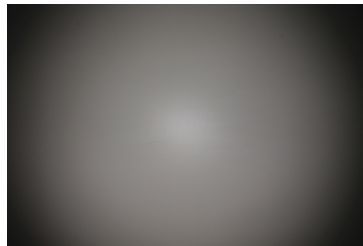

### PHOTOMETRIC DATA (SIMULATED):

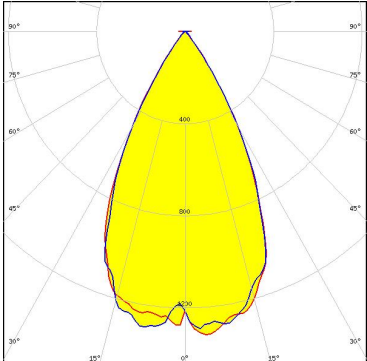
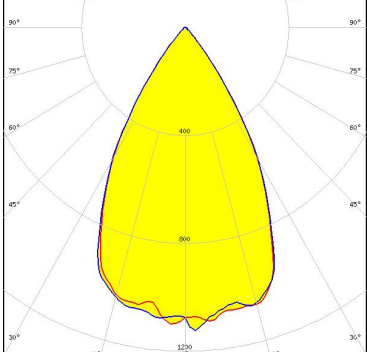
<p><b>CREE</b> LED</p> <p>LED: XP-G3 FWHM / FWTM: 54.0° / 74.0° Efficiency: % LEDs/each optic: 1 Light colour: White Required components: C17899_DAISSY-28X1-SHD-WHT</p>	
<p><b>LUMINUS</b></p> <p>LED: CXM-3 FWHM / FWTM: 60.0° / 82.0° Efficiency: % LEDs/each optic: 1 Light colour: White Required components:</p>	

### GENERAL INFORMATION:

NOTE: The typical beam angle will be changed by different color, chip size and chip position tolerance. The typical total beam angle is the full angle measured where the luminous intensity is half of the peak value.

Due to use of high power COB's with this product, special attention to proper thermal design is highly recommended. LEDiL has no liability for direct, indirect or consecutive damages arising from the LEDiL products being used outside of the recommended temperature range.

### MATERIALS:

As part of our continuous research and improvement processes, and to ensure the best possible quality and availability of our products, LEDiL reserves the right to change material grades without notice.

### PRODUCT DATA USER AGREEMENT AND DISCLAIMER:

The measured data in the provided downloadable LEDiL Product Datasheets and Mechanical 2D-Drawings is rounded and provided as reference for planning. LEDiL Oy's optical specifications have been verified by conducting performance testing of the products in accordance with the company's quality system. The reported data are averaged results of multiple measurements with typical variation. LEDiL Oy reserves the right to without prior notification make changes and improvements to its products.

LEDiL Oy assumes neither warranty, nor guarantee nor any other liability of any kind for the contents and correctness of the provided data. The provided data has been generated with highest diligence but the provided data may in reality not represent the complete possible variation range of all intrinsic parameters. Therefore, in certain cases a deviation from the provided data could occur.

LEDiL Oy reserves the right to undertake technical changes of its products without further notification which could lead to changes in the provided data. LEDiL Oy assumes no liability of any kind for the possible deviation from any provided data or any other damage resulting from the usage of the provided data.

The user agrees to this disclaimer and user agreement with the download or usage of the provided files.

#### LEDiL Oy

Joensuunkatu 13  
FI-24240 SALO  
Finland

#### LEDiL Inc.

228 West Page Street  
Suite D  
Sycamore IL 60178  
USA

#### Ledil Optics Technology (Shenzhen) Co., Ltd.

# 405 , Block B  
Casic Motor Building  
Shenzhen 518057  
P.R.CHINA

#### Local sales and technical support

[www.ledil.com/  
where\\_to\\_buy](http://www.ledil.com/where_to_buy)

#### Shipping locations

Salo, Finland  
Hong Kong, China

#### Distribution Partners

[www.ledil.com/  
where\\_to\\_buy](http://www.ledil.com/where_to_buy)

## X-ON Electronics

Largest Supplier of Electrical and Electronic Components

*Click to view similar products for [LED Lighting Lenses Assemblies](#) category:*

*Click to view products by [Ledil](#) manufacturer:*

Other Similar products are found below :

[CA11362\\_IRIS](#) [CA16127\\_OLGA-S](#) [CP16107\\_CARMEN-50-S-C](#) [CA16129\\_OLGA-W](#) [CA16370\\_HB-SQ-W](#) [FN15972\\_RONDA-ZT45-C](#)  
[CS15759\\_HB-2X2MX-8-W](#) [CA16435\\_LXP2-SS-WAS](#) [CS13756\\_STRADA-IP-2X6-DWC-PC](#) [CN16210\\_GABRIELLA-MIDI-W](#)  
[CP17137\\_CARMEN-M2-C](#) [CA16015\\_STRADA-SQ-SCL](#) [CP17594\\_TINA-SC-RS](#) [CS15767\\_HB-2X2MX-8-M](#) [CP18164\\_AMY-35-ZOOM-B](#)  
[CP10960\\_RGBX-SS](#) [CP12395\\_LXP3-W](#) [CP12939\\_LARISA-RS-CLIP16](#) [C14636\\_XTM-PF-ADAPTER](#) [CA11819\\_STRADA-SQ-T-DW](#)  
[CA14506\\_G2-LXP2-RS2](#) [CA14508\\_G2-LXP2-D](#) [CA14601\\_VERONICA-SQ-MINI-RS](#) [FCP13895\\_SEANNA-A](#) [FP11124\\_LISA2-O-PIN](#)  
[CS14597\\_HB-IP-2X6-O](#) [CP14995\\_FLORENTINA-HLD-O](#) [CS15158\\_STRADA-IP-2X6-T4-B](#) [CS16323\\_STRADELLA-IP-28-HB-M](#)  
[FN14976\\_STELLA-DWC2](#) [FN15264\\_STELLA-HB-WWW](#) [CA15584\\_ZORYA-MINI-TAPE](#) [FA15229\\_ROSE-MRK-S](#) [FA15232\\_ROSE-](#)  
[MRK-M](#) [FCN13552\\_CRYSTAL-RS](#) [FN15552\\_RONDA-W](#) [FS15626\\_FLORENCE-3R-IP-Z90](#) [FS15786\\_FLORENCE-3R-IP-Z60](#)  
[FS15847\\_FLORENCE-3R-IP-O](#) [CA14505\\_G2-LXP2-RS2-P](#) [CP12944\\_LARISA-W-CLIP8](#) [FCN12775\\_IRIS-O](#) [FCA15007\\_G2-ROSE-UV-SS](#)  
[CP15304\\_LARISA-RS-PIN](#) [FN15679\\_RONDA-S](#) [CA15519\\_VERONICA-SQ-MINI-D](#) [FP14414\\_LISA2-O-PIN](#) [LL01CR-DF60L06-M2](#)  
[FN15993\\_RONDA-O](#) [FN15977\\_RONDA-WAS2](#)