

IRIS

~10° spot beam with holder

TECHNICAL SPECIFICATIONS:

Dimensions	Ø 38.0 mm
Height	28.5 mm
Fastening	glue, screw
ROHS compliant	yes ⓘ

MATERIAL SPECIFICATIONS:

Component	Type	Material	Colour	Finish
IRIS	Single lens	PMMA	clear	
IRIS-HLD	Holder	PC	black	







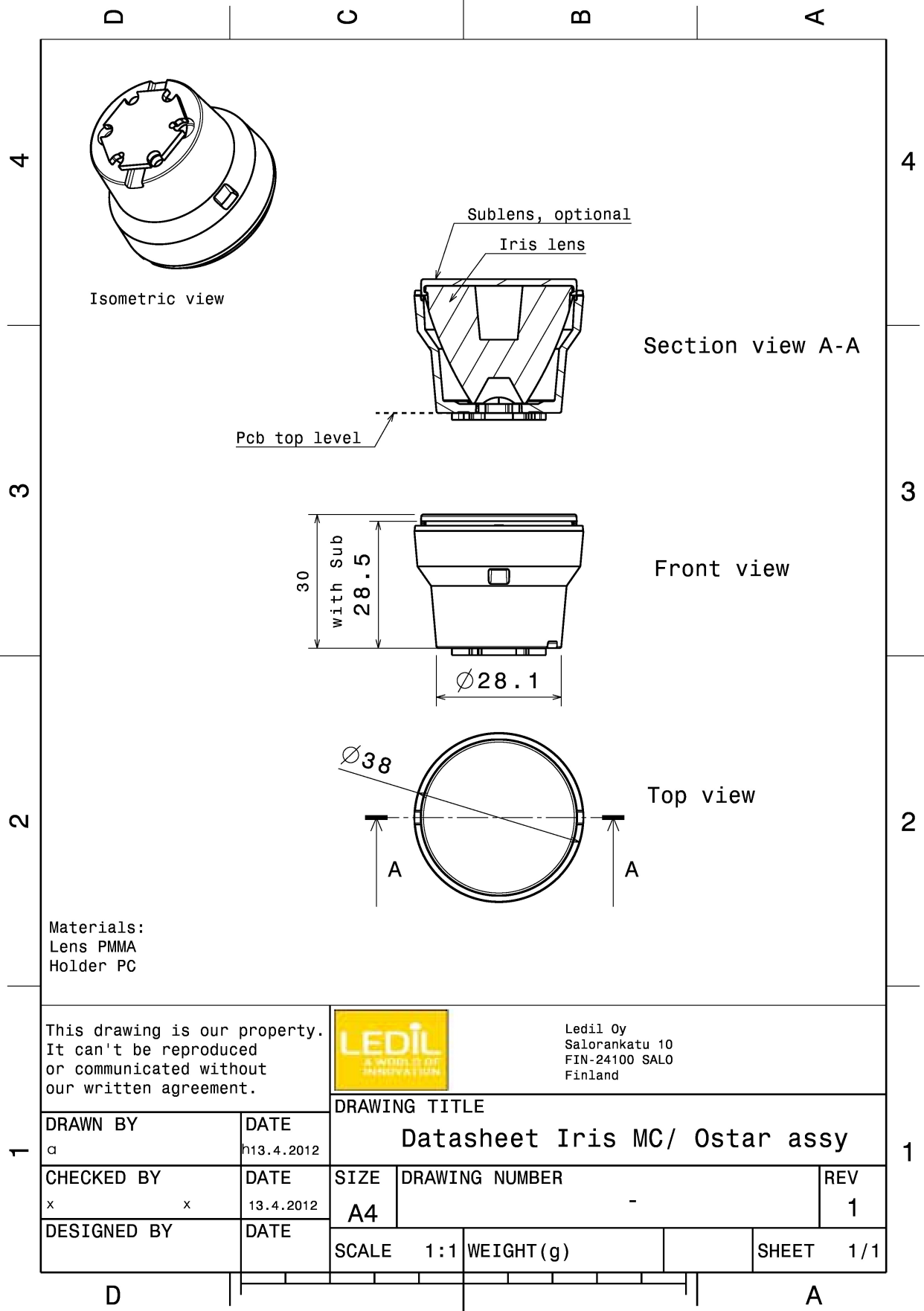

ORDERING INFORMATION:

Component		Qty in box	MOQ	MPQ	Box weight (kg)
CN10861_IRIS	Single lens	580	116	116	0.0
» Box size:					

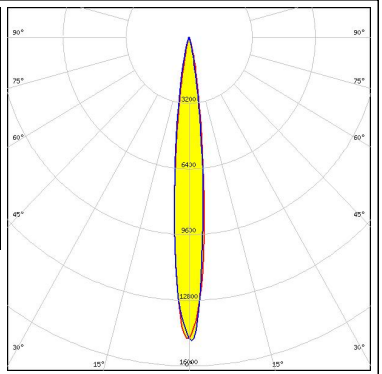

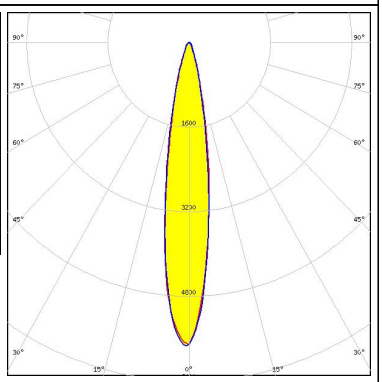
See also our general installation guide: www.ledil.com/installation_guide

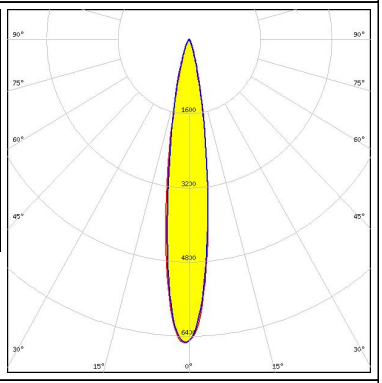
PHOTOMETRIC DATA (MEASURED):

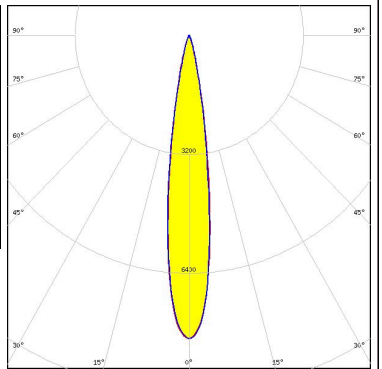
<p>CREE → LED</p> <p>LED MC-E FWHM / FWTM 11.0° / 24.0° Efficiency 89 % Peak intensity 15 cd/lm LEDs/each optic 1 Light colour White Required components:</p>		
<p>CREE → LED</p> <p>LED MHD-E/G FWHM / FWTM 17.0° / 37.0° Efficiency 91 % Peak intensity 5.7 cd/lm LEDs/each optic 1 Light colour White Required components:</p>		
<p>CREE → LED</p> <p>LED XHP50 FWHM / FWTM 16.0° / 33.0° Efficiency 81 % Peak intensity 6.6 cd/lm LEDs/each optic 1 Light colour White Required components:</p>		
<p>CREE → LED</p> <p>LED XHP50.2 FWHM / FWTM 16.0° / 30.0° Efficiency 83 % Peak intensity 8.2 cd/lm LEDs/each optic 1 Light colour White Required components:</p>		

PHOTOMETRIC DATA (MEASURED):

LUMILEDS

LED LUXEON CZ
 FWHM / FWTM 5.0° / 11.0°
 Efficiency 80 %
 Peak intensity 57 cd/lm
 LEDs/each optic 1
 Light colour White
 Required components:

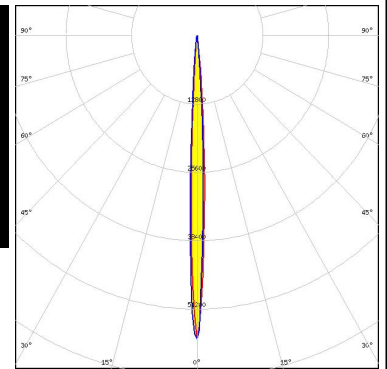

LUMILEDS

LED LUXEON M/MX
 FWHM / FWTM 16.0° / 30.0°
 Efficiency 87 %
 Peak intensity 9.1 cd/lm
 LEDs/each optic 1
 Light colour White
 Required components:

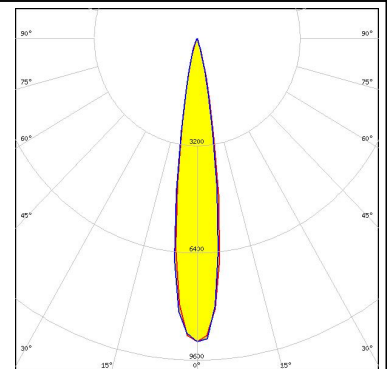

LUMILEDS

LED LUXEON MZ
 FWHM / FWTM 12.0° / 22.0°
 Efficiency 82 %
 Peak intensity 15.8 cd/lm
 LEDs/each optic 1
 Light colour White
 Required components:

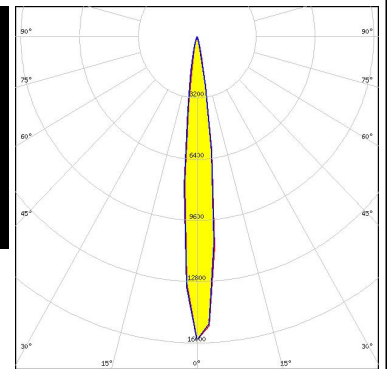



NICHIA

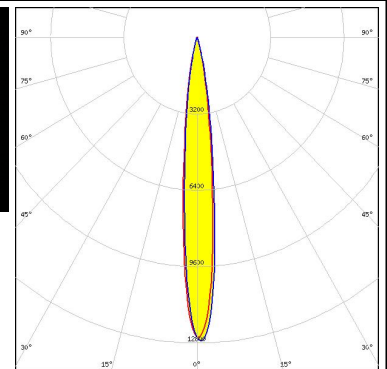



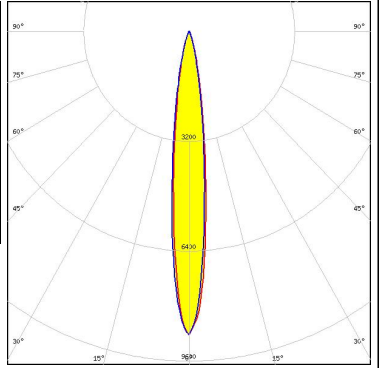

LED NFMW48xA
 FWHM / FWTM 12.0° / 25.0°
 Efficiency 84 %
 Peak intensity 12.8 cd/lm
 LEDs/each optic 1
 Light colour White
 Required components:

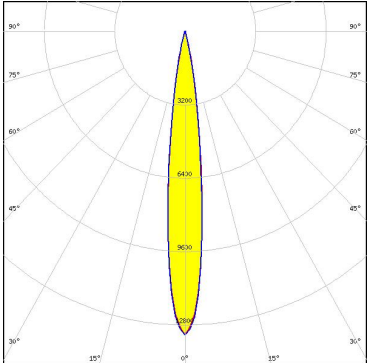

PHOTOMETRIC DATA (MEASURED):

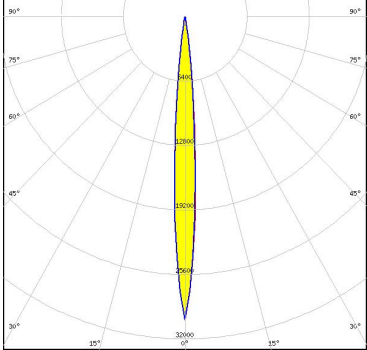
<p>OSRAM Opto Semiconductors</p> <p>LED Duris S10 FWHM / FWTM 13.0° / 29.0° Efficiency 79 % Peak intensity 8.8 cd/lm LEDs/each optic 1 Light colour White Required components:</p>		
<p>OSRAM Opto Semiconductors</p> <p>LED Duris S8 FWHM / FWTM 11.0° / 24.0° Efficiency % LEDs/each optic 1 Light colour White Required components:</p>		
<p>SEOL SEOUL SEMICONDUCTOR</p> <p>LED Z5M1/Z5M2 FWHM / FWTM 7.0° / 14.0° Efficiency 83 % Peak intensity 40.4 cd/lm LEDs/each optic 1 Light colour White Required components:</p>		

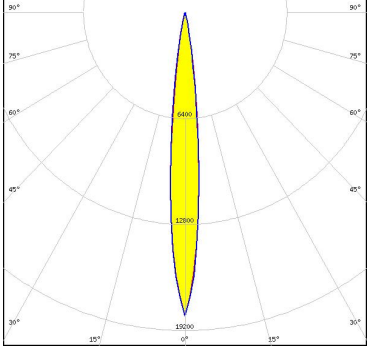
PHOTOMETRIC DATA (SIMULATED):

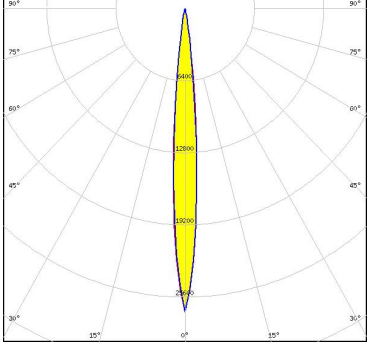
<p> bridgelux.</p> <p>LED: Bridgelux SMD 5050 FWHM / FWTM: 13.0° / 25.0° Efficiency: 91 % Peak intensity: 13.2 cd/lm LEDs/each optic: 1 Light colour: White Required components:</p>	
<p> CREE LED</p> <p>LED: XD16 FWHM / FWTM: 8.0° / 16.0° Efficiency: 82 % Peak intensity: 30.1 cd/lm LEDs/each optic: 1 Light colour: White Required components:</p>	
<p> CREE LED</p> <p>LED: XHP35 HD FWHM / FWTM: 11.0° / 22.0° Efficiency: 91 % Peak intensity: 18.3 cd/lm LEDs/each optic: 1 Light colour: White Required components:</p>	
<p> CREE LED</p> <p>LED: XHP35 HI FWHM / FWTM: 10.0° / 18.0° Efficiency: 90 % Peak intensity: 26.9 cd/lm LEDs/each optic: 1 Light colour: White Required components:</p>	

PHOTOMETRIC DATA (SIMULATED):



LED XHP35.2
 FWHM / FWTM 12.0° / 26.0°
 Efficiency 87 %
 Peak intensity 12.5 cd/lm
 LEDs/each optic 1
 Light colour White
 Required components:

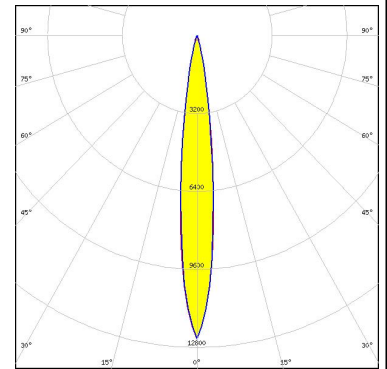

LED XHP50.3 HD
 FWHM / FWTM 14.0° / 24.0°
 Efficiency 87 %
 Peak intensity 13.3 cd/lm
 LEDs/each optic 1
 Light colour White
 Required components:

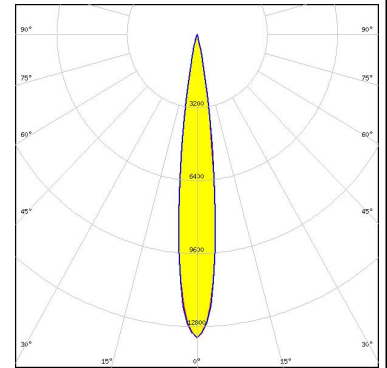

LED XHP50.3 HI
 FWHM / FWTM 12.0° / 22.0°
 Efficiency 88 %
 Peak intensity 17.6 cd/lm
 LEDs/each optic 1
 Light colour White
 Required components:

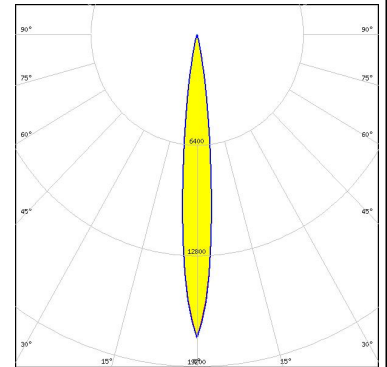

LED XHP70.2
 FWHM / FWTM 20.0° / 36.0°
 Efficiency 84 %
 Peak intensity 5.9 cd/lm
 LEDs/each optic 1
 Light colour White
 Required components:

PHOTOMETRIC DATA (SIMULATED):



LED XHP70.3
 FWHM / FWTM 18.0° / 34.0°
 Efficiency 86 %
 Peak intensity 7 cd/lm
 LEDs/each optic 1
 Light colour White
 Required components:

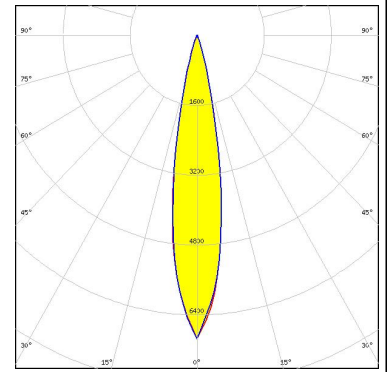

LED XP-E2
 FWHM / FWTM 8.0° / 14.0°
 Efficiency 90 %
 Peak intensity 41.4 cd/lm
 LEDs/each optic 1
 Light colour White
 Required components:

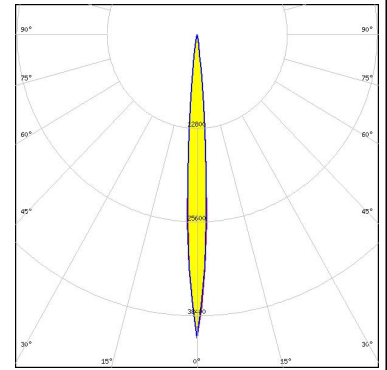

LED LUXEON 3030 2D (Round LES)
 FWHM / FWTM 8.0° / 17.0°
 Efficiency 88 %
 Peak intensity 30.9 cd/lm
 LEDs/each optic 1
 Light colour White
 Required components:

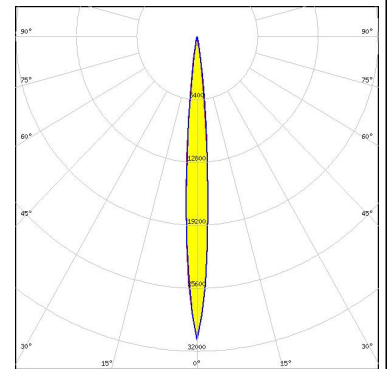

LED LUXEON 5258
 FWHM / FWTM 11.0° / 22.0°
 Efficiency 89 %
 Peak intensity 17.8 cd/lm
 LEDs/each optic 1
 Light colour White
 Required components:

PHOTOMETRIC DATA (SIMULATED):

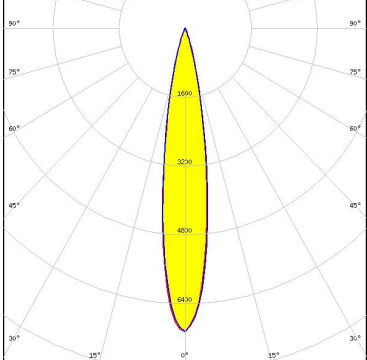
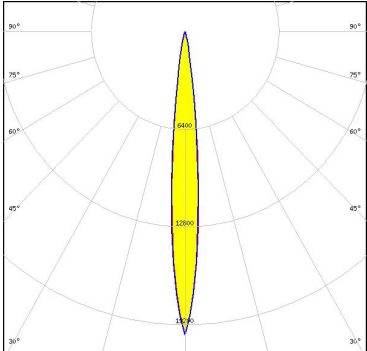
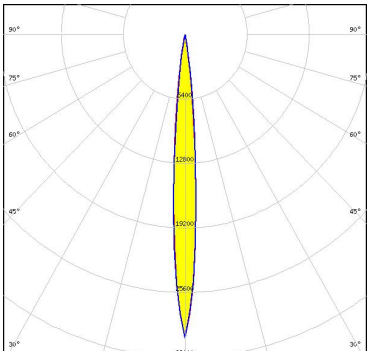
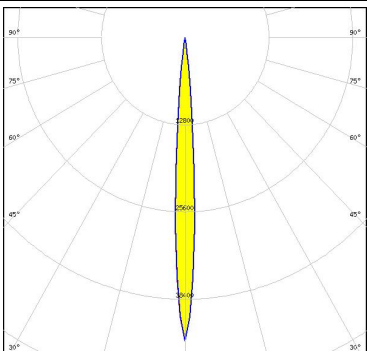
<p>LUMILEDS</p> <p>LED: LUXEON 7070 FWHM / FWTM: 18.0° / 34.0° Efficiency: 86 % Peak intensity: 7.1 cd/lm LEDs/each optic: 1 Light colour: White Required components:</p>	
<p>LUMINUS</p> <p>LED: SST-40 FWHM / FWTM: 10.0° / 21.0° Efficiency: 90 % Peak intensity: 19.9 cd/lm LEDs/each optic: 1 Light colour: White Required components:</p>	
<p>NICHIA</p> <p>LED: NF2x757G FWHM / FWTM: 8.0° / 18.0° Efficiency: 91 % Peak intensity: 30.1 cd/lm LEDs/each optic: 1 Light colour: White Required components:</p>	
<p>OSRAM Opto Semiconductors</p> <p>LED: KW HHL532.TK FWHM / FWTM: 8.0° / 14.0° Efficiency: 88 % Peak intensity: 44.5 cd/lm LEDs/each optic: 1 Light colour: White Required components:</p>	

PHOTOMETRIC DATA (SIMULATED):

OSRAM

Opto Semiconductors

LED KW2 CFLNM2.TK
 FWHM / FWTM 8.0° / 16.0°
 Efficiency 89 %
 Peak intensity 37.2 cd/lm
 LEDs/each optic 1
 Light colour White
 Required components:

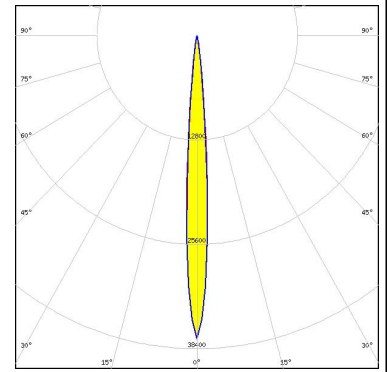

OSRAM

Opto Semiconductors

LED KW2 HIL532.TK
 FWHM / FWTM 8.0° / 16.0°
 Efficiency 88 %
 Peak intensity 34.2 cd/lm
 LEDs/each optic 1
 Light colour White
 Required components:

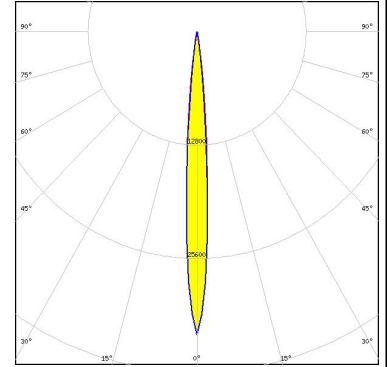

OSRAM

Opto Semiconductors

LED OSCONIQ P 7070
 FWHM / FWTM 14.0° / 23.0°
 Efficiency 87 %
 Peak intensity 13.5 cd/lm
 LEDs/each optic 1
 Light colour White
 Required components:

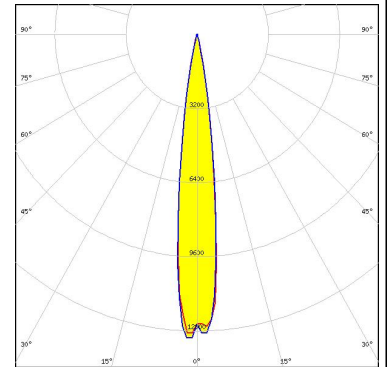

OSRAM

Opto Semiconductors

LED OSLOM Black Flat
 FWHM / FWTM 8.0° / 14.0°
 Efficiency 88 %
 Peak intensity 45.2 cd/lm
 LEDs/each optic 1
 Light colour White
 Required components:

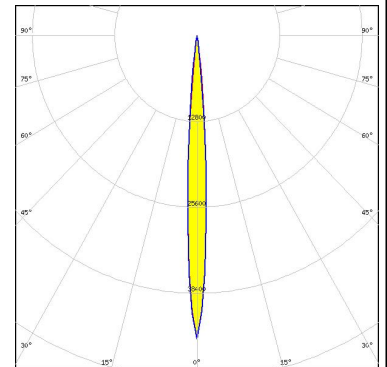

PHOTOMETRIC DATA (SIMULATED):

OSRAM

Opto Semiconductors

LED OSLON Square CSSRM2/CSSRM3
 FWHM / FWTM 7.9° / 16.0°
 Efficiency 89 %
 Peak intensity 36.5 cd/lm
 LEDs/each optic 1
 Light colour White
 Required components:

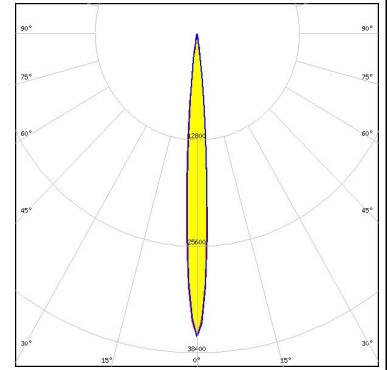

OSRAM

Opto Semiconductors

LED OSLON Square Flat
 FWHM / FWTM 12.0° / 25.0°
 Efficiency 87 %
 Peak intensity 13.8 cd/lm
 LEDs/each optic 1
 Light colour White
 Required components:

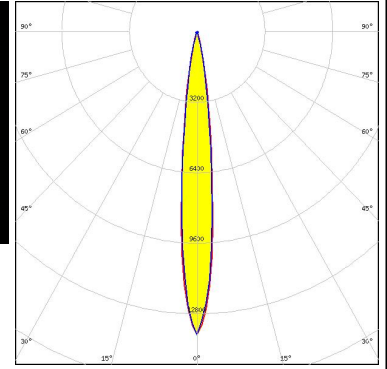
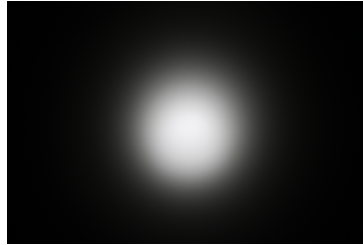

OSRAM

Opto Semiconductors

LED SFH 4715AS
 FWHM / FWTM 8.0° / 16.0°
 Efficiency 89 %
 LEDs/each optic 1
 Light colour IR
 Required components:

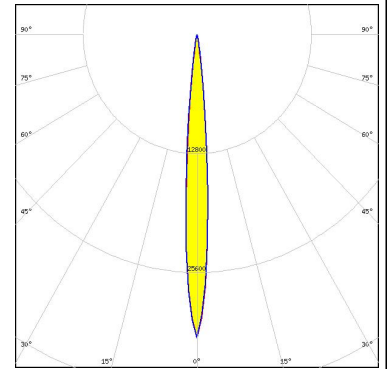





OSRAM

Opto Semiconductors

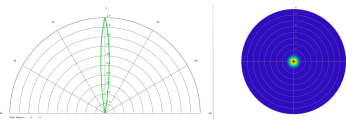
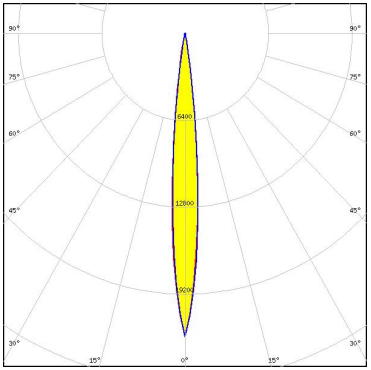
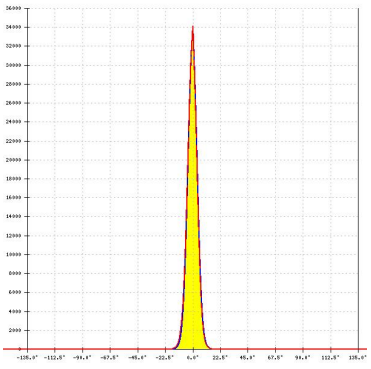
LED SFH 4716AS
 FWHM / FWTM 8.0° / 15.0°
 Efficiency 88 %
 LEDs/each optic 1
 Light colour IR
 Required components:

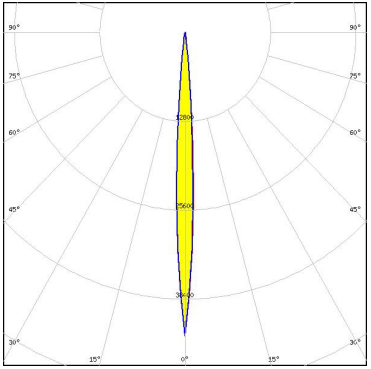
PHOTOMETRIC DATA (SIMULATED):

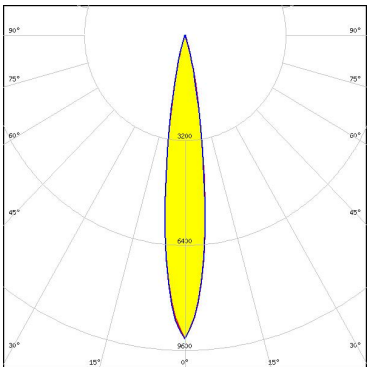
OSRAM <small>Opto Semiconductors</small>	<p>LED SFH 4717AS FWHM / FWTM 10.0° / 19.0° Efficiency 87 % LEDs/each optic 1 Light colour IR Required components:</p>		
OSRAM <small>Opto Semiconductors</small>	<p>LED SFH 4770S FWHM / FWTM 8.1° / 16.6° Efficiency 91 % Peak intensity 3.4 cd/lm LEDs/each optic 1 Light colour IR Required components:</p>		
 <small>SEOUL SEMICONDUCTOR</small>	<p>LED Z8Y22P FWHM / FWTM 6.0° Efficiency 89 % Peak intensity 43.7 cd/lm LEDs/each optic 1 Light colour White Required components:</p>		
 <small>SEOUL SEMICONDUCTOR</small>	<p>LED Z8Y50P FWHM / FWTM 16.0° / 30.0° Efficiency 84 % Peak intensity 9.3 cd/lm LEDs/each optic 1 Light colour White Required components:</p>		

PHOTOMETRIC DATA (SIMULATED):

	
SEOUL SEMICONDUCTOR	
LED	Z8Y50P
FWHM / FWTM	16.0° / 28.0°
Efficiency	84 %
Peak intensity	9.4 cd/lm
LEDs/each optic	1
Light colour	White
Required components:	



GENERAL INFORMATION:

NOTE: The typical beam angle will be changed by different color, chip size and chip position tolerance. The typical total beam angle is the full angle measured where the luminous intensity is half of the peak value.

MATERIALS:

As part of our continuous research and improvement processes, and to ensure the best possible quality and availability of our products, LEDiL reserves the right to change material grades without notice.

PRODUCT DATA USER AGREEMENT AND DISCLAIMER:

The measured data in the provided downloadable LEDiL Product Datasheets and Mechanical 2D-Drawings is rounded and provided as reference for planning. LEDiL Oy's optical specifications have been verified by conducting performance testing of the products in accordance with the company's quality system. The reported data are averaged results of multiple measurements with typical variation. LEDiL Oy reserves the right to without prior notification make changes and improvements to its products.

LEDiL Oy assumes neither warranty, nor guarantee nor any other liability of any kind for the contents and correctness of the provided data. The provided data has been generated with highest diligence but the provided data may in reality not represent the complete possible variation range of all intrinsic parameters. Therefore, in certain cases a deviation from the provided data could occur.

LEDiL Oy reserves the right to undertake technical changes of its products without further notification which could lead to changes in the provided data. LEDiL Oy assumes no liability of any kind for the possible deviation from any provided data or any other damage resulting from the usage of the provided data.

The user agrees to this disclaimer and user agreement with the download or usage of the provided files.

LEDiL Oy

Joensuunkatu 13
FI-24240 SALO
Finland

LEDiL Inc.

228 West Page Street
Suite D
Sycamore IL 60178
USA

Ledil Optics Technology (Shenzhen) Co., Ltd.

405 , Block B
Casic Motor Building
Shenzhen 518057
P.R.CHINA

Local sales and technical support

[www.ledil.com/
where_to_buy](http://www.ledil.com/where_to_buy)

Shipping locations

Salo, Finland
Hong Kong, China

Distribution Partners

[www.ledil.com/
where_to_buy](http://www.ledil.com/where_to_buy)

X-ON Electronics

Largest Supplier of Electrical and Electronic Components

Click to view similar products for [LED Lighting Lenses Assemblies](#) category:

Click to view products by [Ledil](#) manufacturer:

Other Similar products are found below :

[FCN12592_LE1-D-COP](#) [CA16129_OLGA-W](#) [CA16370_HB-SQ-W](#) [FN15972_RONDA-ZT45-C](#) [CS15759_HB-2X2MX-8-W](#)
[CA16435_LXP2-SS-WAS](#) [CN16210_GABRIELLA-MIDI-W](#) [CP17137_CARMEN-M2-C](#) [CA16015_STRADA-SQ-SCL](#) [CP17594_TINA-SC-](#)
[RS](#) [CS15767_HB-2X2MX-8-M](#) [CP10960_RGBX-SS](#) [CP12395_LXP3-W](#) [CP12939_LARISA-RS-CLIP16](#) [C14636_XTM-PF-ADAPTER](#)
[CA11819_STRADA-SQ-T-DW](#) [CA14508_G2-LXP2-D](#) [CA14601_VERONICA-SQ-MINI-RS](#) [FCP13895_SEANNA-A](#) [CP12943_LARISA-](#)
[O-CLIP16](#) [FP11124_LISA2-O-PIN](#) [CS14597_HB-IP-2X6-O](#) [CP14995_FLORENTINA-HLD-O](#) [CS15158_STRADA-IP-2X6-T4-B](#)
[CS16323_STRADELLA-IP-28-HB-M](#) [FN14976_STELLA-DWC2](#) [FN15264_STELLA-HB-WWW](#) [CA15584_ZORYA-MINI-TAPE](#)
[FA15229_ROSE-MRK-S](#) [FA15232_ROSE-MRK-M](#) [FA15233_ROSE-MRK-W](#) [FCN13552_CRYSTAL-RS](#) [FN15552_RONDA-W](#)
[FS15626_FLORENCE-3R-IP-Z90](#) [FS15786_FLORENCE-3R-IP-Z60](#) [FS15847_FLORENCE-3R-IP-O](#) [CA14505_G2-LXP2-RS2-P](#)
[FCN12775_IRIS-O](#) [CP15304_LARISA-RS-PIN](#) [FN15679_RONDA-S](#) [CA15519_VERONICA-SQ-MINI-D](#) [FP14414_LISA2-O-PIN](#)
[LL01CR-DF60L06-M2](#) [FN15993_RONDA-O](#) [FN15977_RONDA-WAS2](#) [CA14366_FLARE-MAXI-TAPE](#) [CA14442_VERONICA-SQ-W](#)
[CA14509_G2-LXP2-M-P](#) [CA15231_VERONICA-SQ-MINI-W](#) [FP11002_LISA2-W-PIN](#)