

## CRYSTAL-RS

~5.1° spot beam. Assembly with holder.

### TECHNICAL SPECIFICATIONS:

Dimensions	Ø 49.7 mm
Height	28.7 mm
Fastening	pin, screw
ROHS compliant	yes ⓘ

### MATERIAL SPECIFICATIONS:

Component	Type	Material	Colour	Finish
CRYSTAL-RS	Single lens	PMMA	clear	
CRYSTAL-HLD	Holder	PC	white	



### ORDERING INFORMATION:

Component		Qty in box	MOQ	MPQ	Box weight (kg)
FCN13552_CRYSTAL-RS	Single lens	288	64	32	0.0
» Box size:					

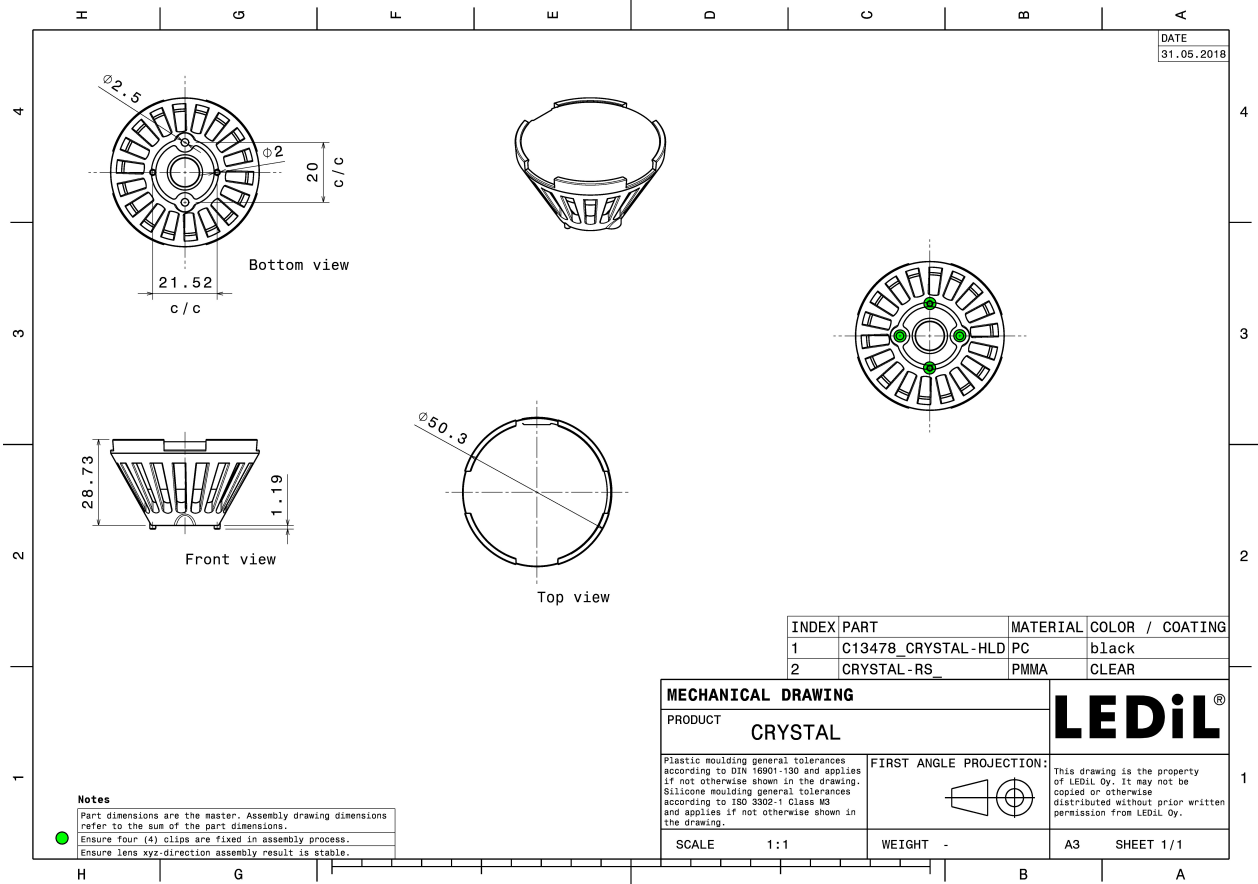

See also our general installation guide: [www.ledil.com/installation\\_guide](http://www.ledil.com/installation_guide)

#### PHOTOMETRIC DATA (MEASURED):

##### CREE LED

LED XHP35 HI  
 FWHM / FWTM 5.7° / 15.0°  
 Efficiency 89 %  
 Peak intensity 48.3 cd/lm  
 LEDs/each optic 1  
 Light colour White  
 Required components:

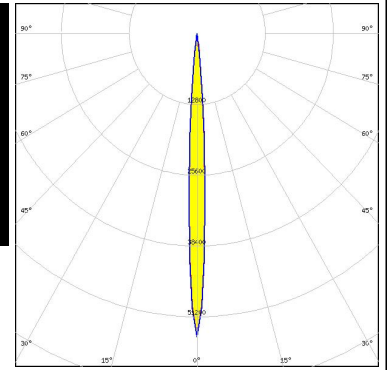
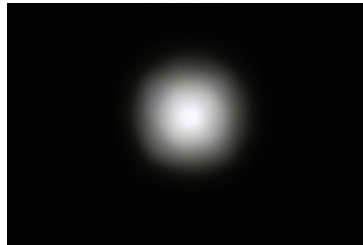

##### CREE LED

LED XHP50  
 FWHM / FWTM 11.0° / 24.0°  
 Efficiency 93 %  
 Peak intensity 14.1 cd/lm  
 LEDs/each optic 1  
 Light colour White  
 Required components:

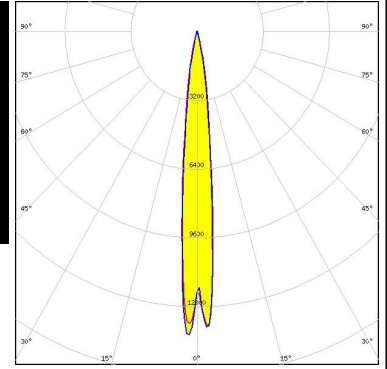
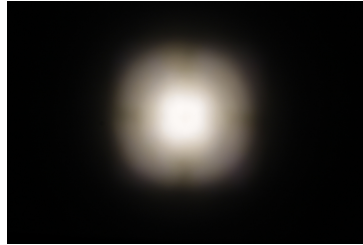

##### CREE LED

LED XM-L  
 FWHM / FWTM 7.0° / 17.0°  
 Efficiency 94 %  
 Peak intensity 34.9 cd/lm  
 LEDs/each optic 1  
 Light colour White  
 Required components:

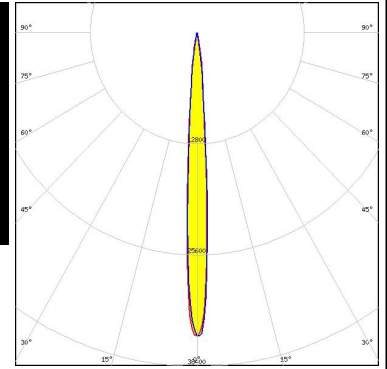

##### CREE LED

LED XP-G  
 FWHM / FWTM 4.9° / 11.4°  
 Efficiency 89 %  
 Peak intensity 68.3 cd/lm  
 LEDs/each optic 1  
 Light colour White  
 Required components:

#### PHOTOMETRIC DATA (MEASURED):



LED XP-L HD  
 FWHM / FWTM 7.0° / 15.0°  
 Efficiency 88 %  
 Peak intensity 34.7 cd/lm  
 LEDs/each optic 1  
 Light colour White  
 Required components:

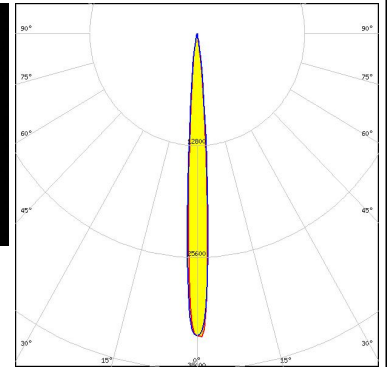

LED LUXEON 3030 2D (Round LES)  
 FWHM / FWTM 4.0° / 15.0°  
 Efficiency 94 %  
 Peak intensity 52.1 cd/lm  
 LEDs/each optic 1  
 Light colour White  
 Required components:

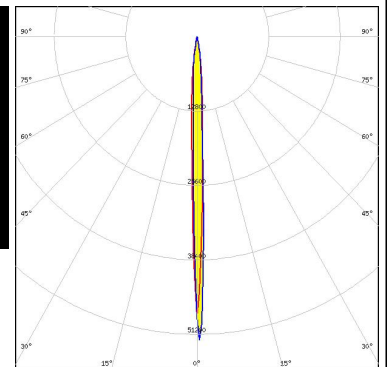
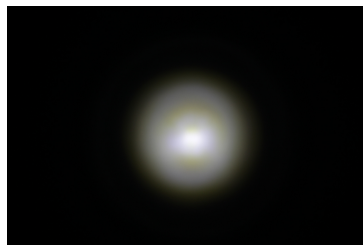



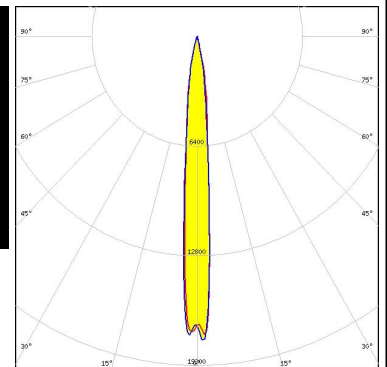
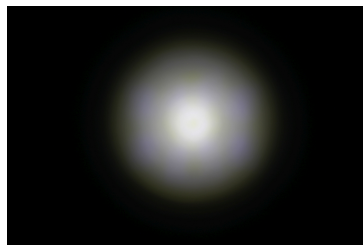

LED LUXEON 5050 Round LES  
 FWHM / FWTM 9.0° / 24.0°  
 Efficiency 94 %  
 Peak intensity 17.8 cd/lm  
 LEDs/each optic 1  
 Light colour White  
 Required components:



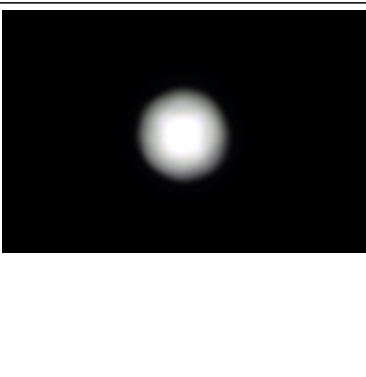
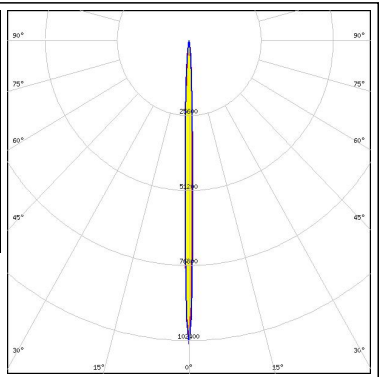

LED LUXEON A  
 FWHM / FWTM 5.1° / 14.0°  
 Efficiency 89 %  
 Peak intensity 58.9 cd/lm  
 LEDs/each optic 1  
 Light colour White  
 Required components:

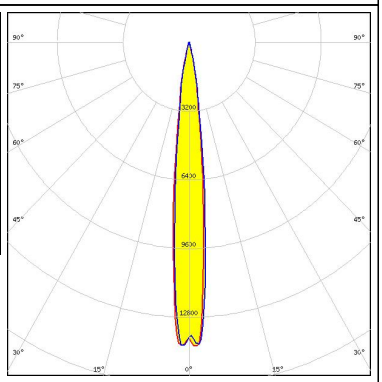
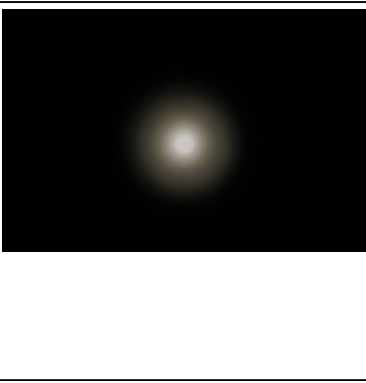
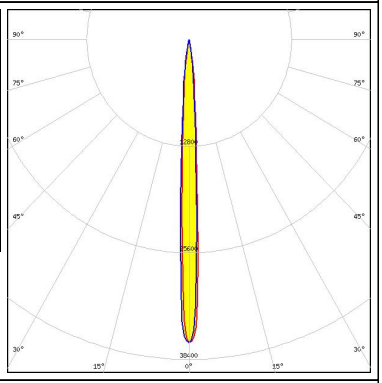

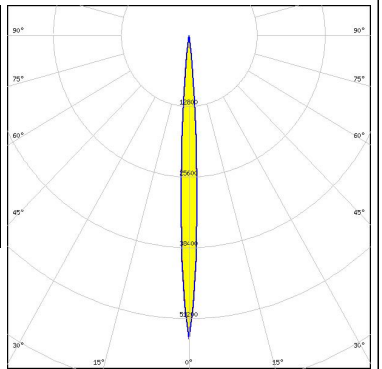
#### PHOTOMETRIC DATA (MEASURED):

<p><b>LUMILEDS</b></p> <p>LED LUXEON Z ES</p> <p>FWHM / FWTM 3.0° / 9.0°</p> <p>Efficiency 93 %</p> <p>Peak intensity 103.8 cd/lm</p> <p>LEDs/each optic 1</p> <p>Light colour White</p> <p>Required components:</p>		
<p><b>NICHIA</b></p> <p>LED NV4x144A</p> <p>FWHM / FWTM 12.0° / 25.0°</p> <p>Efficiency 92 %</p> <p>Peak intensity 14.2 cd/lm</p> <p>LEDs/each optic 1</p> <p>Light colour White</p> <p>Required components:</p>		
<p><b>NICHIA</b></p> <p>LED NVSW3x9A</p> <p>FWHM / FWTM 6.0° / 16.0°</p> <p>Efficiency 89 %</p> <p>Peak intensity 36.5 cd/lm</p> <p>LEDs/each optic 1</p> <p>Light colour White</p> <p>Required components:</p>		
<p><b>NICHIA</b></p> <p>LED NVSxx19B/NVSxx19C</p> <p>FWHM / FWTM 5.3° / 17.0°</p> <p>Efficiency 89 %</p> <p>Peak intensity 42.5 cd/lm</p> <p>LEDs/each optic 1</p> <p>Light colour White</p> <p>Required components:</p>		

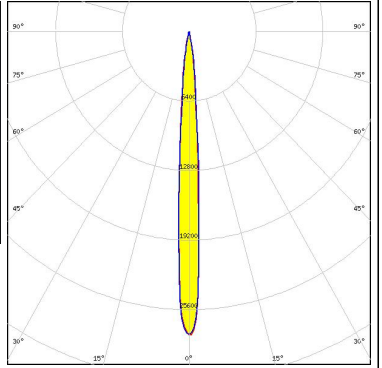
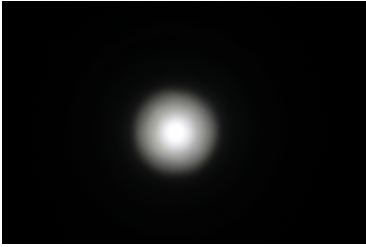
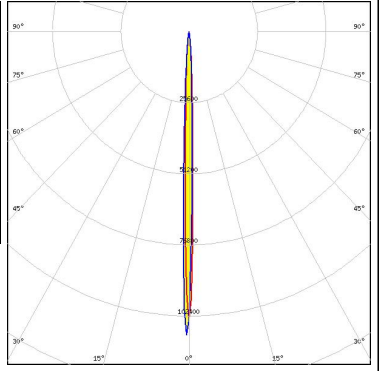
#### PHOTOMETRIC DATA (MEASURED):

<p><b>NICHIA</b></p> <p>LED NWSx229A            FWHM / FWTM 8.0° / 18.0°            Efficiency 92 %            Peak intensity 27.9 cd/lm            LEDs/each optic 1            Light colour White            Required components:</p>		
<p><b>OSRAM</b>  <small>Opto Semiconductors</small></p> <p>LED OSLON SSL 150            FWHM / FWTM 3.0° / 9.0°            Efficiency 94 %            Peak intensity 108.9 cd/lm            LEDs/each optic 1            Light colour White            Required components:</p>		
<p><b>SAMSUNG</b></p> <p>LED LH351B            FWHM / FWTM 5.3° / 14.0°            Efficiency 90 %            Peak intensity 57 cd/lm            LEDs/each optic 1            Light colour White            Required components:</p>		
<p><b>SAMSUNG</b></p> <p>LED LH351Z            FWHM / FWTM 4.4° / 12.0°            Efficiency 90 %            Peak intensity 77 cd/lm            LEDs/each optic 1            Light colour White            Required components:</p>		

### PHOTOMETRIC DATA (MEASURED):





#### PHOTOMETRIC DATA (SIMULATED):



LED XHP50.3 HI  
 FWHM / FWTM 10.0 + 8.0° / 18.0°  
 Efficiency 97 %  
 Peak intensity 27.4 cd/lm  
 LEDs/each optic 1  
 Light colour White  
 Required components:

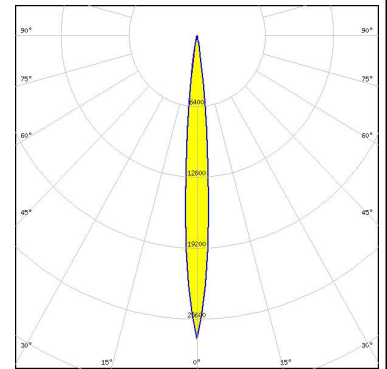

LED XHP70.2  
 FWHM / FWTM 16.0° / 30.0°  
 Efficiency 95 %  
 Peak intensity 9 cd/lm  
 LEDs/each optic 1  
 Light colour White  
 Required components:

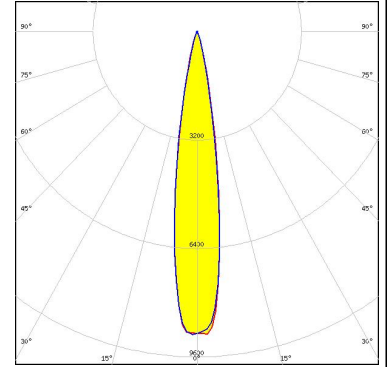

LED XP-L HI  
 FWHM / FWTM 5.6° / 12.0°  
 Efficiency 94 %  
 Peak intensity 70.2 cd/lm  
 LEDs/each optic 1  
 Light colour White  
 Required components:

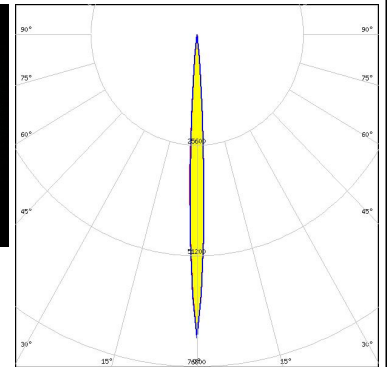

LED XP-P  
 FWHM / FWTM 4.0° / 10.0°  
 Efficiency 95 %  
 Peak intensity 115.4 cd/lm  
 LEDs/each optic 1  
 Light colour White  
 Required components:

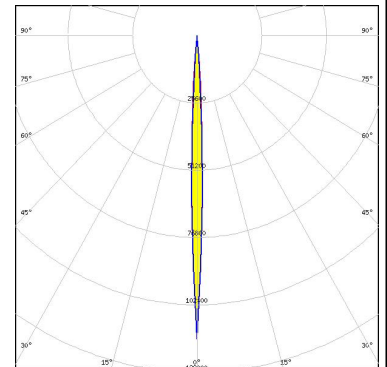

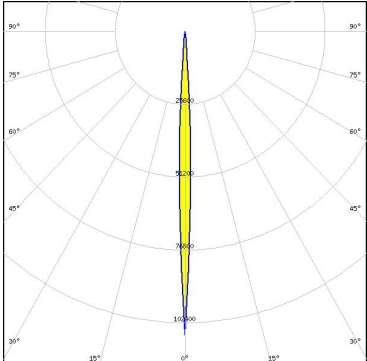
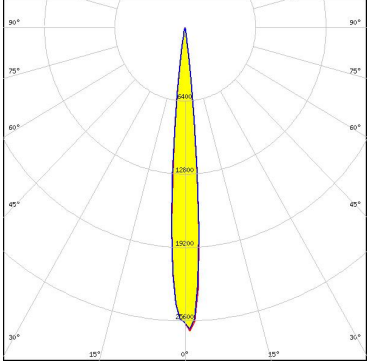
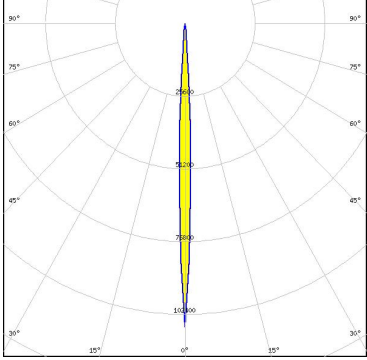
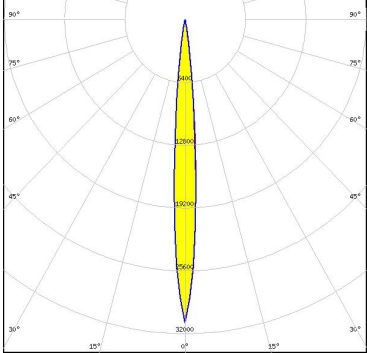

#### PHOTOMETRIC DATA (SIMULATED):

<p><b>CREE</b> LED</p> <p>LED: XQ-E HI            FWHM / FWTM: 4.5° / 10.0°            Efficiency: 95 %            Peak intensity: 106.7 cd/lm            LEDs/each optic: 1            Light colour: White            Required components:</p>	
<p><b>LUMILEDS</b></p> <p>LED: LUXEON Rubix (white)            FWHM / FWTM: 10.0° / 17.0°            Efficiency: 97 %            Peak intensity: 26.8 cd/lm            LEDs/each optic: 4            Light colour: RGBW            Required components:</p>	
<p><b>LUMILEDS</b></p> <p>LED: LUXEON Rubix (white)            FWHM / FWTM: 4.0° / 10.0°            Efficiency: 95 %            Peak intensity: 106.8 cd/lm            LEDs/each optic: 1            Light colour: White            Required components:</p>	
<p><b>LUMILEDS</b></p> <p>LED: LUXEON V            FWHM / FWTM: 8.0° / 17.0°            Efficiency: 95 %            Peak intensity: 30.9 cd/lm            LEDs/each optic: 1            Light colour: White            Required components:</p>	

#### PHOTOMETRIC DATA (SIMULATED):

<p><b>LUMINUS</b></p> <p>LED SBT-90</p> <p>FWHM / FWTM 8.0° / 18.0°</p> <p>Efficiency 97 %</p> <p>Peak intensity 33.1 cd/lm</p> <p>LEDs/each optic 1</p> <p>Light colour White</p> <p>Required components:</p>	
<p><b>LUMINUS</b></p> <p>LED SST-40</p> <p>FWHM / FWTM 8.0° / 16.0°</p> <p>Efficiency 97 %</p> <p>Peak intensity 31.7 cd/lm</p> <p>LEDs/each optic 1</p> <p>Light colour White</p> <p>Required components:</p>	
<p><b>OSRAM</b> Opto Semiconductors</p> <p>LED Duris S5 (Single chip)</p> <p>FWHM / FWTM 4.0° / 10.0°</p> <p>Efficiency 95 %</p> <p>Peak intensity 101.9 cd/lm</p> <p>LEDs/each optic 1</p> <p>Light colour Green</p> <p>Required components:</p>	
<p><b>OSRAM</b> Opto Semiconductors</p> <p>LED Duris S5 (Single chip)</p> <p>FWHM / FWTM 4.0° / 10.0°</p> <p>Efficiency 95 %</p> <p>Peak intensity 106 cd/lm</p> <p>LEDs/each optic 1</p> <p>Light colour Red</p> <p>Required components:</p>	

#### PHOTOMETRIC DATA (SIMULATED):

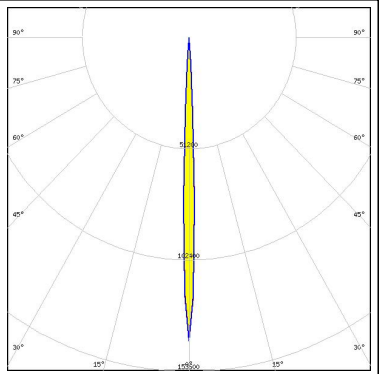
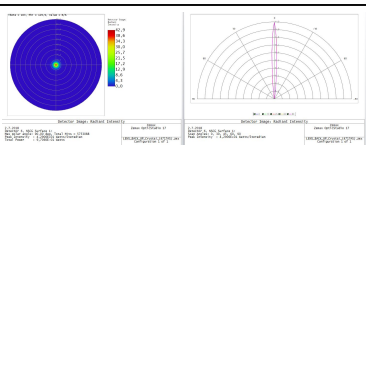
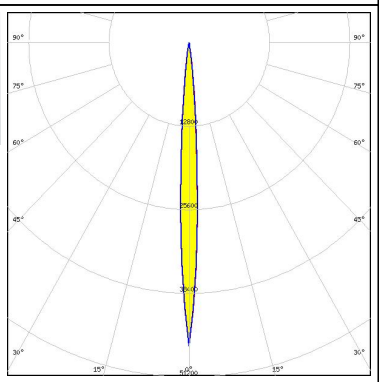
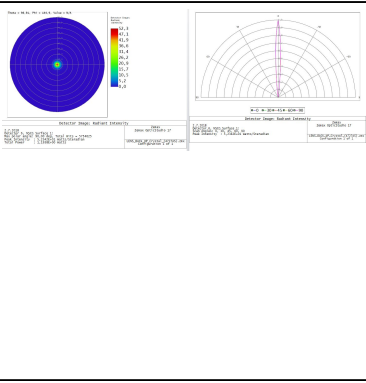
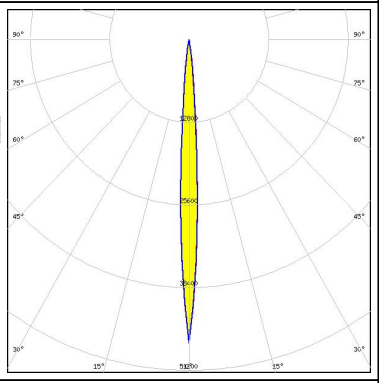
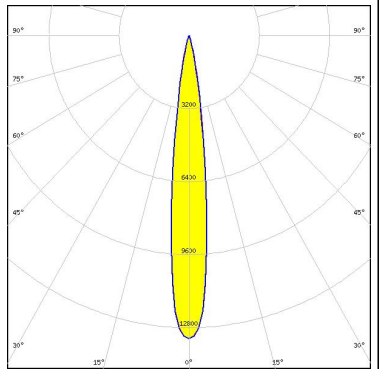
<p><b>OSRAM</b> Opto Semiconductors</p> <p>LED OSTAR Projection Compact (Kx.CSLNM1.xx)</p> <p>FWHM / FWTM 4.0° / 8.0°</p> <p>Efficiency 94 %</p> <p>Peak intensity 139.7 cd/lm</p> <p>LEDs/each optic 1</p> <p>Light colour White</p> <p>Required components:</p>		
<p><b>OSRAM</b> Opto Semiconductors</p> <p>LED SFH 4717AS</p> <p>FWHM / FWTM 6.7° / 14.5°</p> <p>Efficiency 94 %</p> <p>Peak intensity 46.5 cd/lm</p> <p>LEDs/each optic 1</p> <p>Light colour White</p> <p>Required components:</p>		
<p><b>OSRAM</b> Opto Semiconductors</p> <p>LED SFH 4727AS</p> <p>FWHM / FWTM 6.7° / 14.5°</p> <p>Efficiency 94 %</p> <p>Peak intensity 47 cd/lm</p> <p>LEDs/each optic 1</p> <p>Light colour White</p> <p>Required components:</p>		
<p><b>SEOL</b> SEOL SEMICONDUCTOR</p> <p>LED Z8Y50P</p> <p>FWHM / FWTM 14.0° / 26.0°</p> <p>Efficiency 97 %</p> <p>Peak intensity 13.3 cd/lm</p> <p>LEDs/each optic 1</p> <p>Light colour White</p> <p>Required components:</p>		

### GENERAL INFORMATION:

NOTE: The typical beam angle will be changed by different color, chip size and chip position tolerance. The typical total beam angle is the full angle measured where the luminous intensity is half of the peak value.

### MATERIALS:

As part of our continuous research and improvement processes, and to ensure the best possible quality and availability of our products, LEDiL reserves the right to change material grades without notice.

### PRODUCT DATA USER AGREEMENT AND DISCLAIMER:

The measured data in the provided downloadable LEDiL Product Datasheets and Mechanical 2D-Drawings is rounded and provided as reference for planning. LEDiL Oy's optical specifications have been verified by conducting performance testing of the products in accordance with the company's quality system. The reported data are averaged results of multiple measurements with typical variation. LEDiL Oy reserves the right to without prior notification make changes and improvements to its products.

LEDiL Oy assumes neither warranty, nor guarantee nor any other liability of any kind for the contents and correctness of the provided data. The provided data has been generated with highest diligence but the provided data may in reality not represent the complete possible variation range of all intrinsic parameters. Therefore, in certain cases a deviation from the provided data could occur.

LEDiL Oy reserves the right to undertake technical changes of its products without further notification which could lead to changes in the provided data. LEDiL Oy assumes no liability of any kind for the possible deviation from any provided data or any other damage resulting from the usage of the provided data.

The user agrees to this disclaimer and user agreement with the download or usage of the provided files.

#### LEDiL Oy

Joensuunkatu 13  
FI-24240 SALO  
Finland

#### LEDiL Inc.

228 West Page Street  
Suite D  
Sycamore IL 60178  
USA

#### Ledil Optics Technology (Shenzhen) Co., Ltd.

# 405 , Block B  
Casic Motor Building  
Shenzhen 518057  
P.R.CHINA

#### Local sales and technical support

[www.ledil.com/  
where\\_to\\_buy](http://www.ledil.com/where_to_buy)

#### Shipping locations

Salo, Finland  
Hong Kong, China

#### Distribution Partners

[www.ledil.com/  
where\\_to\\_buy](http://www.ledil.com/where_to_buy)

## X-ON Electronics

Largest Supplier of Electrical and Electronic Components

*Click to view similar products for [LED Lighting Lenses Assemblies](#) category:*

*Click to view products by [Ledil](#) manufacturer:*

Other Similar products are found below :

[FCN12592\\_LE1-D-COP](#) [CA16129\\_OLGA-W](#) [CA16370\\_HB-SQ-W](#) [FN15972\\_RONDA-ZT45-C](#) [CS15759\\_HB-2X2MX-8-W](#)  
[CA16435\\_LXP2-SS-WAS](#) [CN16210\\_GABRIELLA-MIDI-W](#) [CP17137\\_CARMEN-M2-C](#) [CA16015\\_STRADA-SQ-SCL](#) [CP17594\\_TINA-SC-](#)  
[RS](#) [CS15767\\_HB-2X2MX-8-M](#) [CP10960\\_RGBX-SS](#) [CP12395\\_LXP3-W](#) [CP12939\\_LARISA-RS-CLIP16](#) [C14636\\_XTM-PF-ADAPTER](#)  
[CA11819\\_STRADA-SQ-T-DW](#) [CA14508\\_G2-LXP2-D](#) [CA14601\\_VERONICA-SQ-MINI-RS](#) [FCP13895\\_SEANNA-A](#) [CP12943\\_LARISA-](#)  
[O-CLIP16](#) [FP11124\\_LISA2-O-PIN](#) [CS14597\\_HB-IP-2X6-O](#) [CP14995\\_FLORENTINA-HLD-O](#) [CS15158\\_STRADA-IP-2X6-T4-B](#)  
[CS16323\\_STRADELLA-IP-28-HB-M](#) [FN14976\\_STELLA-DWC2](#) [FN15264\\_STELLA-HB-WWW](#) [CA15584\\_ZORYA-MINI-TAPE](#)  
[FA15229\\_ROSE-MRK-S](#) [FA15232\\_ROSE-MRK-M](#) [FA15233\\_ROSE-MRK-W](#) [FCN13552\\_CRYSTAL-RS](#) [FN15552\\_RONDA-W](#)  
[FS15626\\_FLORENCE-3R-IP-Z90](#) [FS15786\\_FLORENCE-3R-IP-Z60](#) [FS15847\\_FLORENCE-3R-IP-O](#) [CA14505\\_G2-LXP2-RS2-P](#)  
[FCN12775\\_IRIS-O](#) [CP15304\\_LARISA-RS-PIN](#) [FN15679\\_RONDA-S](#) [CA15519\\_VERONICA-SQ-MINI-D](#) [FP14414\\_LISA2-O-PIN](#)  
[LL01CR-DF60L06-M2](#) [FN15993\\_RONDA-O](#) [FN15977\\_RONDA-WAS2](#) [CA14366\\_FLARE-MAXI-TAPE](#) [CA14442\\_VERONICA-SQ-W](#)  
[CA14509\\_G2-LXP2-M-P](#) [CA15231\\_VERONICA-SQ-MINI-W](#) [FP11002\\_LISA2-W-PIN](#)