

IRENE-IR-4

~65° + 65° rectangular beam

TECHNICAL SPECIFICATIONS:

Dimensions	Ø 21.6 mm
Height	14.3 mm
Fastening	glue, pin
ROHS compliant	yes ⓘ

MATERIAL SPECIFICATIONS:

Component	Type	Material	Colour	Finish
IRENE-4	Multi-lens	PMMA	clear	
IRENE-HLD	Holder	PC	white	

ORDERING INFORMATION:

Component	Type	Qty in box	MOQ	MPQ	Box weight (kg)
CP13069_IRENE-IR-4	Multi-lens	1792	336	112	10.6
» Box size: 480 x 280 x 300 mm					



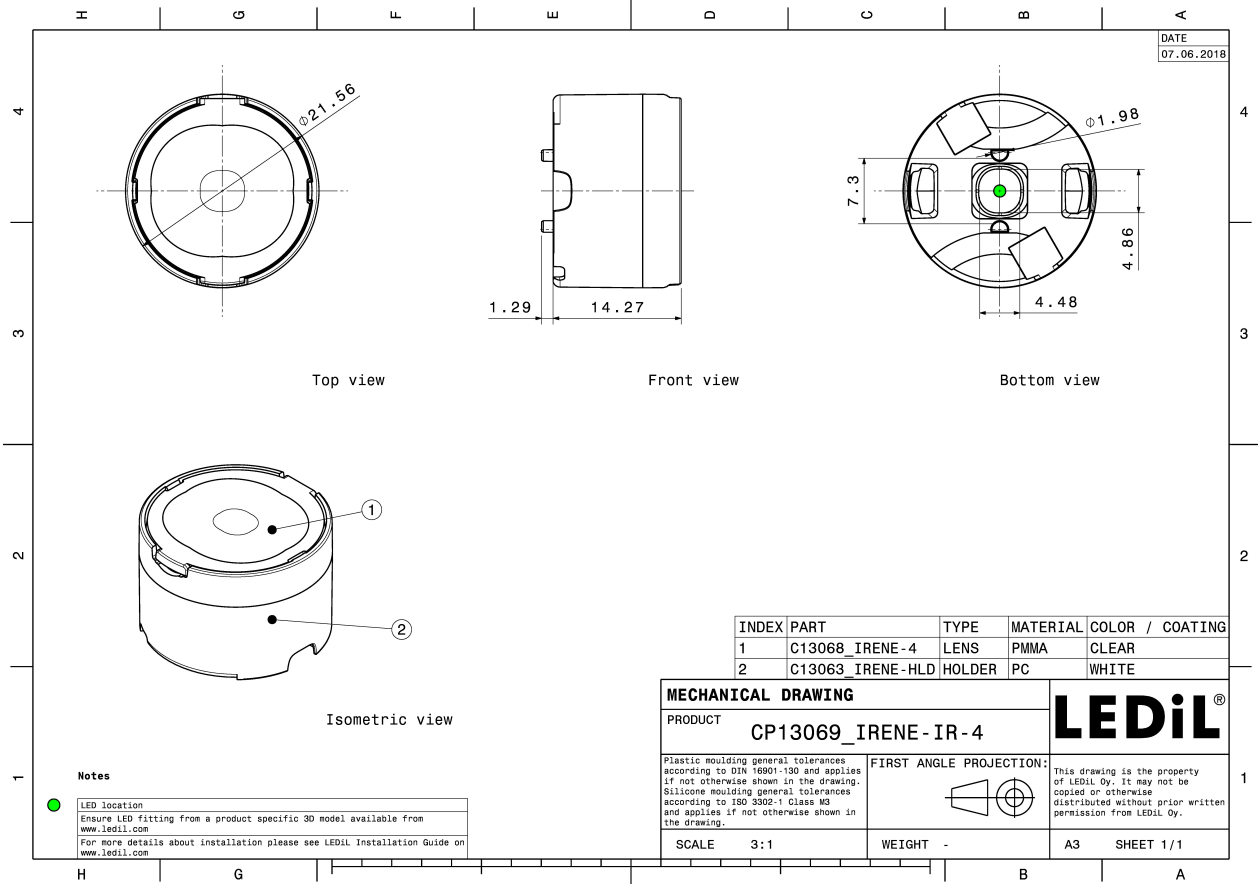

See also our general installation guide: www.ledil.com/installation_guide

PHOTOMETRIC DATA (MEASURED):

OSRAM
Opto Semiconductors

LED SFH 4715S
FWHM / FWTM 67.0°
Efficiency %
LEDs/each optic 1
Light colour White
Required components:

OSRAM
Opto Semiconductors

LED SFH 4725S
FWHM / FWTM 68.0° / 96.0°
Efficiency %
LEDs/each optic 1
Light colour White
Required components:

PHOTOMETRIC DATA (SIMULATED):

LUMILEDS

LED: LUXEON IR 2720
 FWHM / FWTM: 74.0 + 66.0° / 97.0 + 92.0°
 Efficiency: 93 %
 LEDs/each optic: 1
 Light colour: IR
 Required components:



LUMILEDS

LED: LUXEON IR Compact
 FWHM / FWTM: 72.0 + 62.0° / 89.0 + 83.0°
 Efficiency: 79 %
 LEDs/each optic: 1
 Light colour: White
 Required components:

OSRAM
 Opto Semiconductors

LED: SFH 4714A
 FWHM / FWTM: 78.0 + 66.0° / 102.0 + 91.0°
 Efficiency: 71 %
 LEDs/each optic: 1
 Light colour: IR
 Required components:

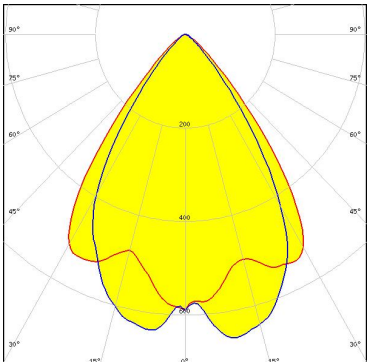
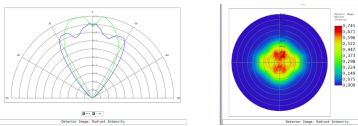
OSRAM
 Opto Semiconductors

LED: SFH 4725AS
 FWHM / FWTM: 70.0 + 62.0° / 91.0 + 85.0°
 Efficiency: 92 %
 LEDs/each optic: 1
 Light colour: IR
 Required components:



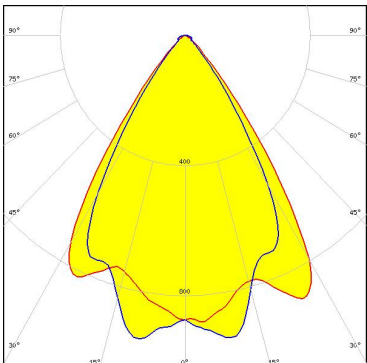
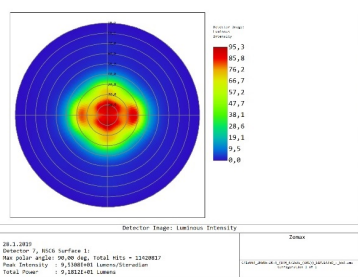



Detector Stage: Luminous Intensity	Value
95.3	
85.8	
76.2	
66.7	
57.2	
47.7	
38.1	
28.6	
19.1	
9.5	
0.0	

20.1.2021
 Detector: 1, BSC Surface 1:
 The detector angle: 90.00 deg. Dist. Axis = 112.0007
 Peak Intensity: 9.108046E Lumens/steradian
 Total Power: 1.910321E lumens

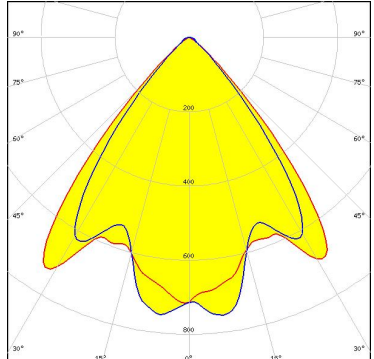
PHOTOMETRIC DATA (SIMULATED):

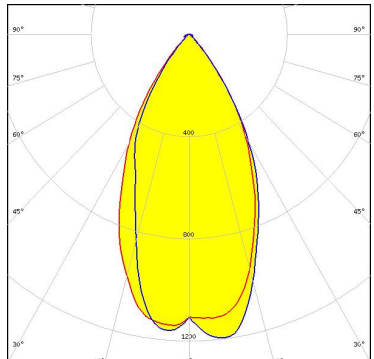
<p>OSRAM Opto Semiconductors</p> <p>LED SFH 4770S FWHM / FWTM 63.0 + 53.0° / 89.0 + 82.0° Efficiency 92 % LEDs/each optic 1 Light colour White Required components:</p>		
<p>STANLEY</p> <p>LED FWR1107MS FWHM / FWTM 66.0 + 59.0° / 91.0 + 84.0° Efficiency 93 % LEDs/each optic 1 Light colour IR Required components:</p>		
<p>STANLEY</p> <p>LED FWR1108MS FWHM / FWTM 75.0 + 67.0° / 97.0 + 91.0° Efficiency 92 % LEDs/each optic 1 Light colour IR Required components:</p>		
<p>STANLEY</p> <p>LED MFN1107MS FWHM / FWTM 53.0° / 84.0° Efficiency 91 % Peak intensity 1.2 cd/lm LEDs/each optic 1 Light colour IR Required components:</p>		

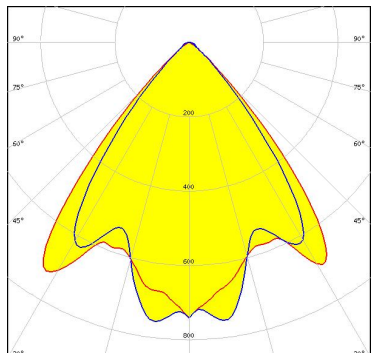
PHOTOMETRIC DATA (SIMULATED):

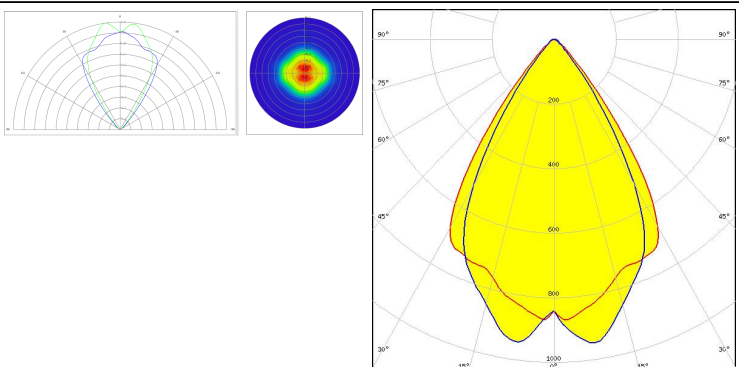
	<p>LED MFN1108MS FWHM / FWTM 81.0° / 99.0° Efficiency 91 % Peak intensity 0.8 cd/lm LEDs/each optic 1 Light colour IR Required components:</p>	
	<p>LED MGN1107MS FWHM / FWTM 53.0° / 84.0° Efficiency 91 % Peak intensity 1.2 cd/lm LEDs/each optic 1 Light colour IR Required components:</p>	
	<p>LED MGN1108MS FWHM / FWTM 81.0° / 99.0° Efficiency 91 % Peak intensity 0.8 cd/lm LEDs/each optic 1 Light colour IR Required components:</p>	
	<p>LED MJN1107MS FWHM / FWTM 69.0 + 61.0° / 91.0 + 88.0° Efficiency 92 % LEDs/each optic 1 Light colour IR Required components:</p>	

PHOTOMETRIC DATA (SIMULATED):

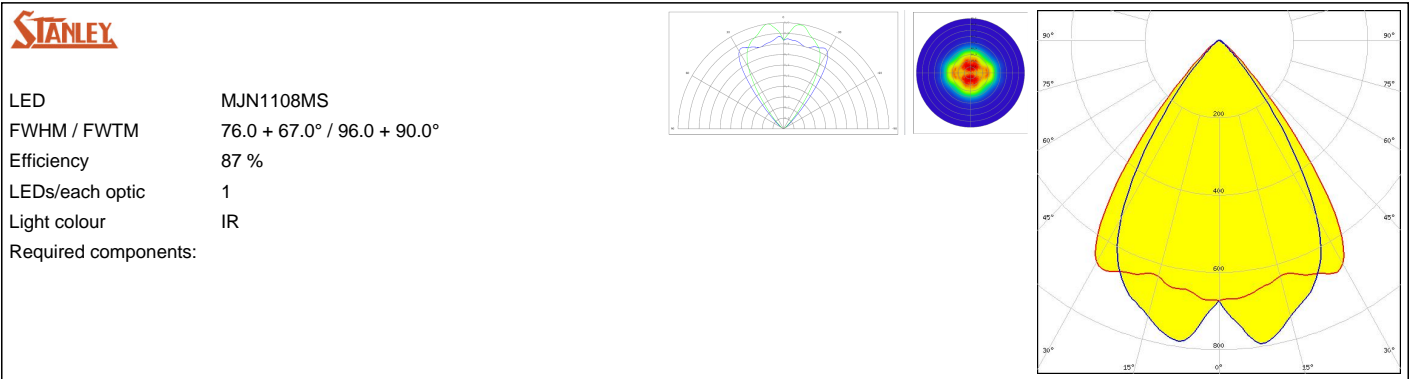

GENERAL INFORMATION:

NOTE: The typical beam angle will be changed by different color, chip size and chip position tolerance. The typical total beam angle is the full angle measured where the luminous intensity is half of the peak value.

MATERIALS:

As part of our continuous research and improvement processes, and to ensure the best possible quality and availability of our products, LEDiL reserves the right to change material grades without notice.

PRODUCT DATA USER AGREEMENT AND DISCLAIMER:

The measured data in the provided downloadable LEDiL Product Datasheets and Mechanical 2D-Drawings is rounded and provided as reference for planning. LEDiL Oy's optical specifications have been verified by conducting performance testing of the products in accordance with the company's quality system. The reported data are averaged results of multiple measurements with typical variation. LEDiL Oy reserves the right to without prior notification make changes and improvements to its products.

LEDiL Oy assumes neither warranty, nor guarantee nor any other liability of any kind for the contents and correctness of the provided data. The provided data has been generated with highest diligence but the provided data may in reality not represent the complete possible variation range of all intrinsic parameters. Therefore, in certain cases a deviation from the provided data could occur.

LEDiL Oy reserves the right to undertake technical changes of its products without further notification which could lead to changes in the provided data. LEDiL Oy assumes no liability of any kind for the possible deviation from any provided data or any other damage resulting from the usage of the provided data.

The user agrees to this disclaimer and user agreement with the download or usage of the provided files.

LEDiL Oy

Joensuunkatu 13
FI-24240 SALO
Finland

LEDiL Inc.

228 West Page Street
Suite D
Sycamore IL 60178
USA

Ledil Optics Technology (Shenzhen) Co., Ltd.

405 , Block B
Casic Motor Building
Shenzhen 518057
P.R.CHINA

Local sales and technical support

[www.ledil.com/
where_to_buy](http://www.ledil.com/where_to_buy)

Shipping locations

Salo, Finland
Hong Kong, China

Distribution Partners

[www.ledil.com/
where_to_buy](http://www.ledil.com/where_to_buy)

X-ON Electronics

Largest Supplier of Electrical and Electronic Components

Click to view similar products for [LED Lighting Lenses Assemblies](#) category:

Click to view products by [Ledil](#) manufacturer:

Other Similar products are found below :

[FCN12592_LE1-D-COP](#) [CA16129_OLGA-W](#) [CA16370_HB-SQ-W](#) [FN15972_RONDA-ZT45-C](#) [CS15759_HB-2X2MX-8-W](#)
[CA16435_LXP2-SS-WAS](#) [CN16210_GABRIELLA-MIDI-W](#) [CP17137_CARMEN-M2-C](#) [CA16015_STRADA-SQ-SCL](#) [CP17594_TINA-SC-](#)
[RS](#) [CS15767_HB-2X2MX-8-M](#) [CP10960_RGBX-SS](#) [CP12395_LXP3-W](#) [CP12939_LARISA-RS-CLIP16](#) [C14636_XTM-PF-ADAPTER](#)
[CA11819_STRADA-SQ-T-DW](#) [CA14508_G2-LXP2-D](#) [CA14601_VERONICA-SQ-MINI-RS](#) [FCP13895_SEANNA-A](#) [CP12943_LARISA-](#)
[O-CLIP16](#) [FP11124_LISA2-O-PIN](#) [CS14597_HB-IP-2X6-O](#) [CP14995_FLORENTINA-HLD-O](#) [CS15158_STRADA-IP-2X6-T4-B](#)
[CS16323_STRADELLA-IP-28-HB-M](#) [FN14976_STELLA-DWC2](#) [FN15264_STELLA-HB-WWW](#) [CA15584_ZORYA-MINI-TAPE](#)
[FA15229_ROSE-MRK-S](#) [FA15232_ROSE-MRK-M](#) [FA15233_ROSE-MRK-W](#) [FCN13552_CRYSTAL-RS](#) [FN15552_RONDA-W](#)
[FS15626_FLORENCE-3R-IP-Z90](#) [FS15786_FLORENCE-3R-IP-Z60](#) [FS15847_FLORENCE-3R-IP-O](#) [CA14505_G2-LXP2-RS2-P](#)
[FCN12775_IRIS-O](#) [CP15304_LARISA-RS-PIN](#) [FN15679_RONDA-S](#) [CA15519_VERONICA-SQ-MINI-D](#) [FP14414_LISA2-O-PIN](#)
[LL01CR-DF60L06-M2](#) [FN15993_RONDA-O](#) [FN15977_RONDA-WAS2](#) [CA14366_FLARE-MAXI-TAPE](#) [CA14442_VERONICA-SQ-W](#)
[CA14509_G2-LXP2-M-P](#) [CA15231_VERONICA-SQ-MINI-W](#) [FP11002_LISA2-W-PIN](#)