

CARMEN-RS-C

~10° spot beam. Assembly with holder C compatible with LEDiL HEKLA.

TECHNICAL SPECIFICATIONS:

Dimensions	Ø 69.5 mm
Height	41.5 mm
Fastening	socket
ROHS compliant	yes ⓘ



MATERIAL SPECIFICATIONS:

Component	Type	Material	Colour	Finish
CARMEN-RS	Single lens	PMMA	clear	
CARMEN-HLD-C	Holder	PC	black	





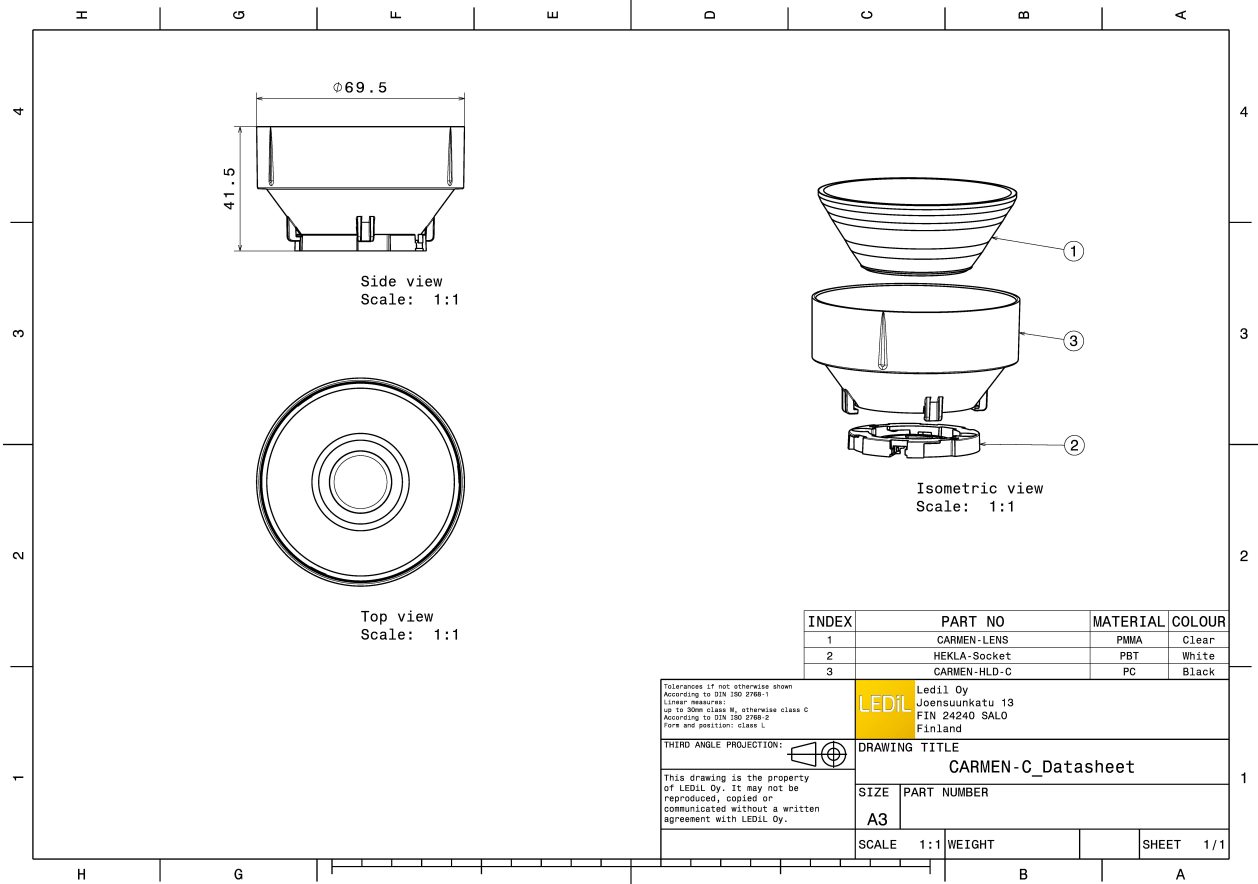

ORDERING INFORMATION:

Component	Type	Qty in box	MOQ	MPQ	Box weight (kg)
CP15916_CARMEN-RS-C » Box size: 480 x 280 x 300 mm	Single lens	150	150	15	6.2

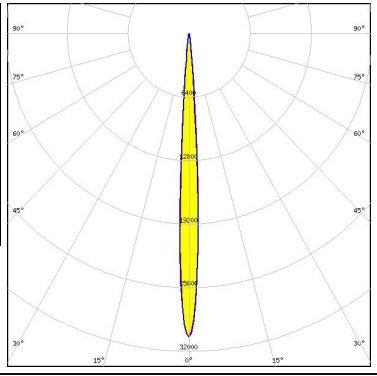

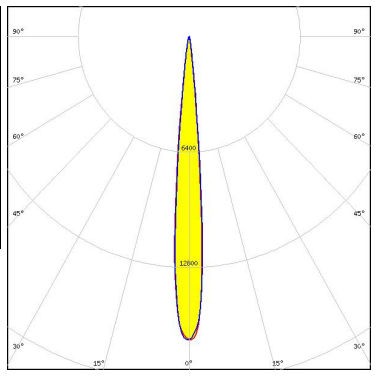
See also our general installation guide: www.ledil.com/installation_guide

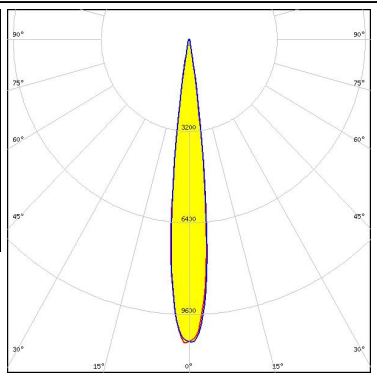
PHOTOMETRIC DATA (MEASURED):

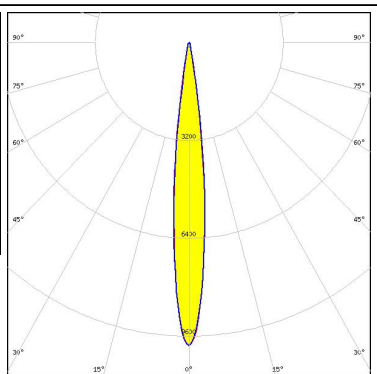
<p>bridgelux.</p> <p>LED V4 HD</p> <p>FWHM / FWTM 7.0° / 12.0°</p> <p>Efficiency 68 %</p> <p>Peak intensity 31 cd/lm</p> <p>LEDs/each optic 1</p> <p>Light colour White</p> <p>Required components: F15253_HEKLA-SOCKET-A</p>		
<p>bridgelux.</p> <p>LED V6 HD</p> <p>FWHM / FWTM 9.6° / 15.0°</p> <p>Efficiency 65 %</p> <p>Peak intensity 16.9 cd/lm</p> <p>LEDs/each optic 1</p> <p>Light colour White</p> <p>Required components: F15255_HEKLA-SOCKET-C</p>		
<p>bridgelux.</p> <p>LED V9 HD</p> <p>FWHM / FWTM 13.0° / 20.0°</p> <p>Efficiency 63 %</p> <p>Peak intensity 10.6 cd/lm</p> <p>LEDs/each optic 1</p> <p>Light colour White</p> <p>Required components: F15859_HEKLA-SOCKET-I</p>		
<p>bridgelux.</p> <p>LED VERO10</p> <p>FWHM / FWTM 12.0° / 21.0°</p> <p>Efficiency 61 %</p> <p>Peak intensity 9.9 cd/lm</p> <p>LEDs/each optic 1</p> <p>Light colour White</p> <p>Required components: F15616_HEKLA-SOCKET-F</p>		

PHOTOMETRIC DATA (MEASURED):

bridgelux.

LED Vesta TW 6mm DP
 FWHM / FWTM 9.0° / 16.0°
 Efficiency 59 %
 Peak intensity 16.5 cd/lm
 LEDs/each optic 1
 Light colour White

Required components:
 C16142_HEKLA-SOCKET-K
 Bender Wirth: 504 Typ L8



bridgelux.

LED Vesta TW 9mm (9W) DP
 FWHM / FWTM 12.0° / 23.0°
 Efficiency 56 %
 Peak intensity 7.8 cd/lm
 LEDs/each optic 1
 Light colour White

Required components:
 C16142_HEKLA-SOCKET-K
 Bender Wirth: 489 Typ L8



CITIZEN

LED CLL02x/CLU02x (LES10)
 FWHM / FWTM 13.0° / 22.0°
 Efficiency 59 %
 Peak intensity 8.6 cd/lm
 LEDs/each optic 1
 Light colour White

Required components:
 F15255_HEKLA-SOCKET-C



CITIZEN

LED CLU700/701/702
 FWHM / FWTM 9.0° / 15.0°
 Efficiency 69 %
 Peak intensity 22.6 cd/lm
 LEDs/each optic 1
 Light colour White

Required components:
 F15255_HEKLA-SOCKET-C

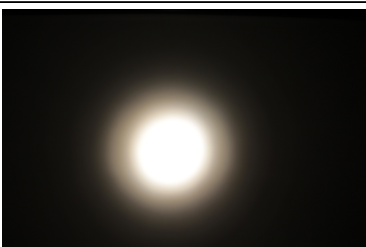
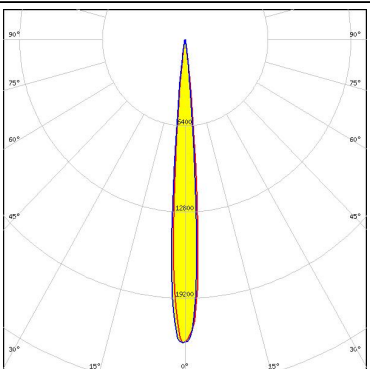
PHOTOMETRIC DATA (MEASURED):

CITIZEN

LED CLU700/701/702
 FWHM / FWTM 8.0° / 15.0°
 Efficiency 62 %
 Peak intensity 20.2 cd/lm
 LEDs/each optic 1
 Light colour White
 Required components:
 F15255_HEKLA-SOCKET-C

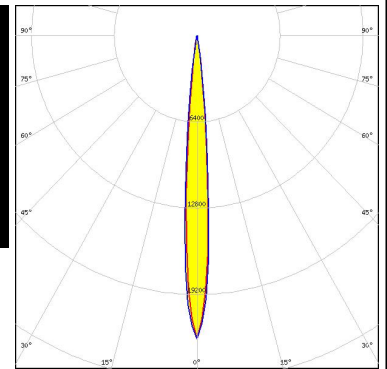

CITIZEN

LED CLU710/711
 FWHM / FWTM 12.0° / 19.0°
 Efficiency 64 %
 Peak intensity 11.5 cd/lm
 LEDs/each optic 1
 Light colour White
 Required components:
 F15859_HEKLA-SOCKET-I

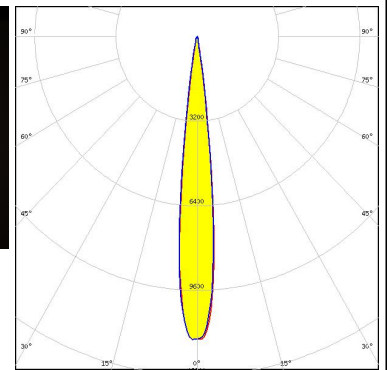
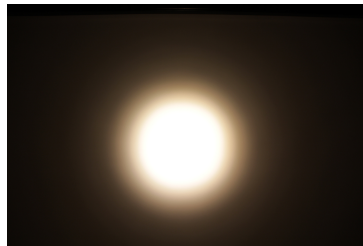

CITIZEN

LED CLU7A2 (LES 4.2mm)
 FWHM / FWTM 6.0° / 11.0°
 Efficiency 65 %
 Peak intensity 34.7 cd/lm
 LEDs/each optic 1
 Light colour White
 Required components:
 F15255_HEKLA-SOCKET-C

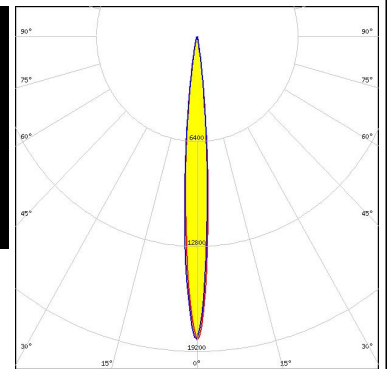





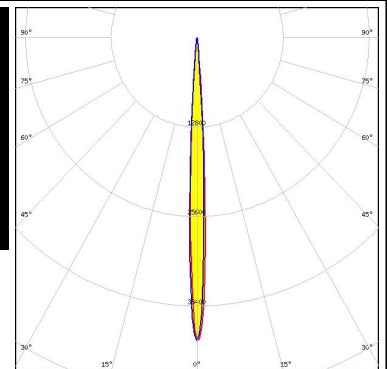
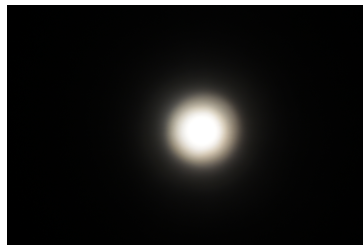

CITIZEN

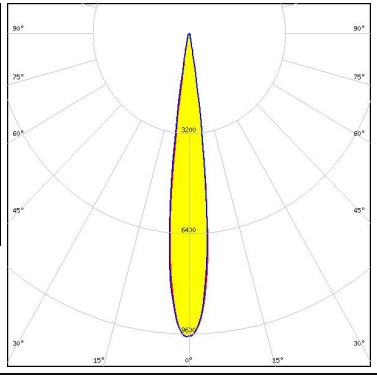

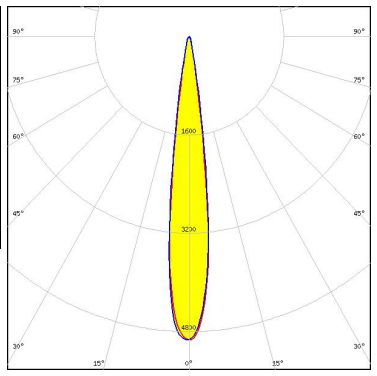

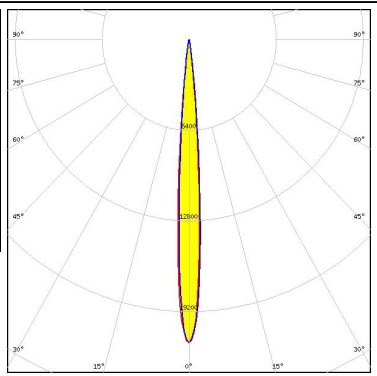

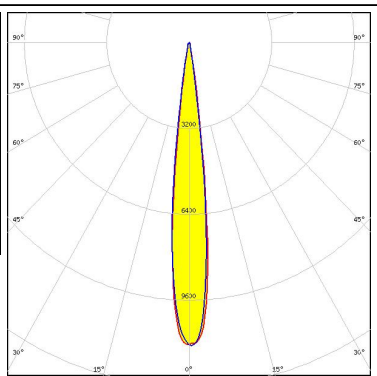
LED CLU7B2
 FWHM / FWTM 6.0° / 10.0°
 Efficiency 66 %
 Peak intensity 43.4 cd/lm
 LEDs/each optic 1
 Light colour White
 Required components:
 F15255_HEKLA-SOCKET-C

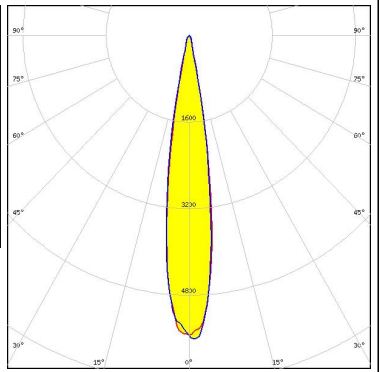

PHOTOMETRIC DATA (MEASURED):

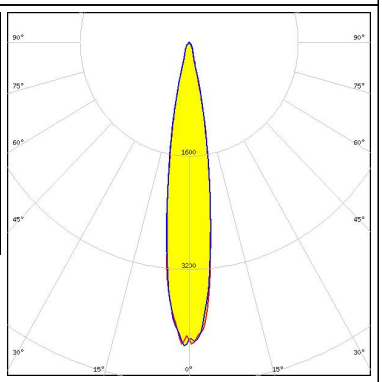
<p>CREE LED</p> <p>LED CMA1516 FWHM / FWTM 13.0° / 20.0° Efficiency 63 % Peak intensity 9.7 cd/lm LEDs/each optic 1 Light colour White Required components: F15256_HEKLA-SOCKET-D</p>		
<p>CREE LED</p> <p>LED CMT14xx FWHM / FWTM 14.0° / 23.0° Efficiency 40 % Peak intensity 5 cd/lm LEDs/each optic 1 Light colour White Required components: F15255_HEKLA-SOCKET-C</p>		
<p>CREE LED</p> <p>LED CXA/B 13xx FWHM / FWTM 8.0° / 15.0° Efficiency 64 % Peak intensity 21.4 cd/lm LEDs/each optic 1 Light colour White Required components: F15956_HEKLA-SOCKET-J</p>		
<p>CREE LED</p> <p>LED CXA/B 15xx FWHM / FWTM 13.0° / 20.0° Efficiency 65 % Peak intensity 11.3 cd/lm LEDs/each optic 1 Light colour White Required components: F15256_HEKLA-SOCKET-D</p>		

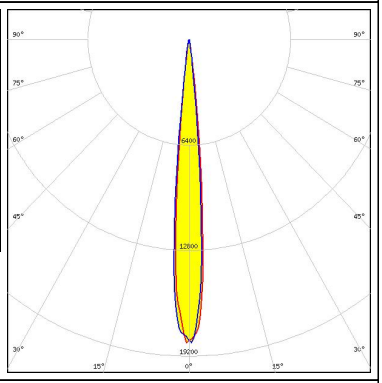
PHOTOMETRIC DATA (MEASURED):

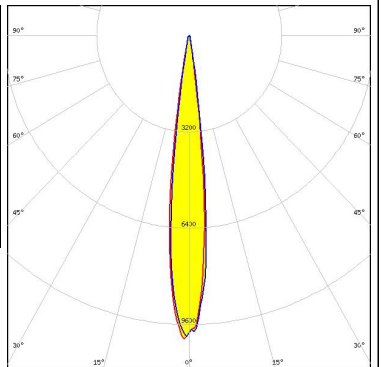
<p>CREE LED</p> <p>LED CXA/B 1816 & CXA/B 1820 & CXA 1850</p> <p>FWHM / FWTM 17.0° / 26.0°</p> <p>Efficiency 59 %</p> <p>Peak intensity 5.6 cd/lm</p> <p>LEDs/each optic 1</p> <p>Light colour White</p> <p>Required components: F15256_HEKLA-SOCKET-D</p>		
<p>LUMILEDS</p> <p>LED LUXEON CX Plus CoB L08 (Gen2)</p> <p>FWHM / FWTM 17.0° / 30.0°</p> <p>Efficiency 54 %</p> <p>Peak intensity 4.3 cd/lm</p> <p>LEDs/each optic 1</p> <p>Light colour White</p> <p>Required components: Bender Wirth: 637a Hekla</p>		
<p>LUMILEDS</p> <p>LED LUXEON CoB 1202HD</p> <p>FWHM / FWTM 9.7° / 15.0°</p> <p>Efficiency 66 %</p> <p>Peak intensity 18.5 cd/lm</p> <p>LEDs/each optic 1</p> <p>Light colour White</p> <p>Required components: F15848_HEKLA-SOCKET-G</p>		
<p>LUMILEDS</p> <p>LED LUXEON CoB 1204HD</p> <p>FWHM / FWTM 13.0° / 20.0°</p> <p>Efficiency 63 %</p> <p>Peak intensity 10 cd/lm</p> <p>LEDs/each optic 1</p> <p>Light colour White</p> <p>Required components: F15858_HEKLA-SOCKET-H</p>		

PHOTOMETRIC DATA (MEASURED):

LUMILEDS

LED LUXEON CoB 1205HD
 FWHM / FWTM 15.0° / 25.0°
 Efficiency 59 %
 Peak intensity 6.4 cd/lm
 LEDs/each optic 1
 Light colour White
 Required components:
 F15858_HEKLA-SOCKET-H

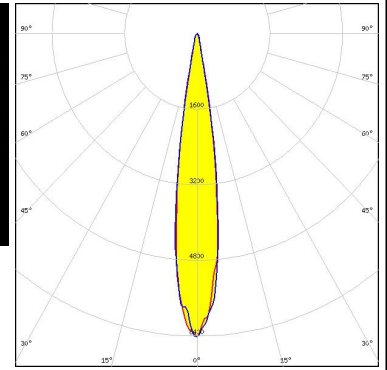
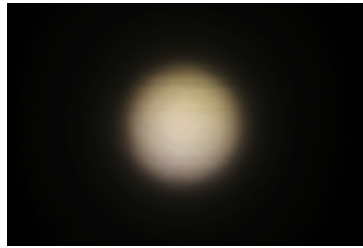

LUMILEDS

LED LUXEON CX Plus CoB - HD S01H4
 FWHM / FWTM 8.0° / 14.0°
 Efficiency 67 %
 Peak intensity 27.5 cd/lm
 LEDs/each optic 1
 Light colour White
 Required components:
 Bender Wirth: 634c Hekla

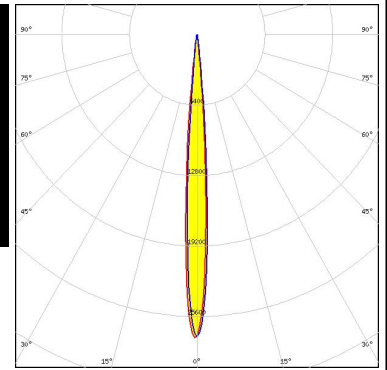
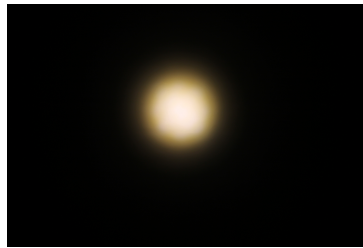

LUMILEDS

LED LUXEON CX Plus CoB - HD S04H9
 FWHM / FWTM 13.0° / 20.0°
 Efficiency 61 %
 Peak intensity 10.3 cd/lm
 LEDs/each optic 1
 Light colour White
 Required components:
 Bender Wirth: 634c Hekla

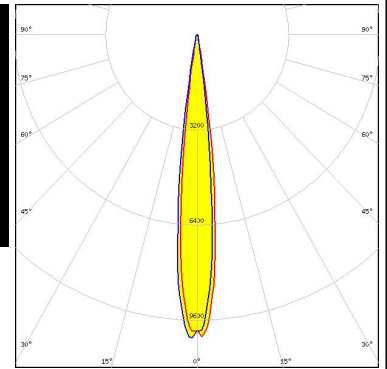



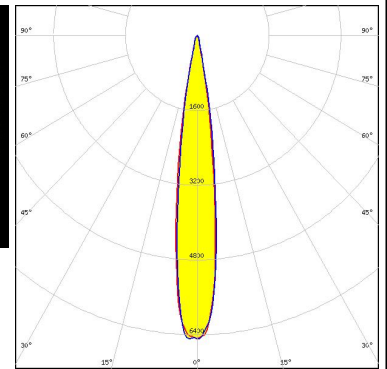

LUMILEDS

LED LUXEON CX Plus CoB L04 / L05 (Gen2)
 FWHM / FWTM 15.0° / 26.0°
 Efficiency 58 %
 Peak intensity 6.5 cd/lm
 LEDs/each optic 1
 Light colour White
 Required components:
 Bender Wirth: 637a Hekla

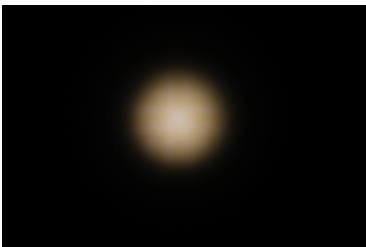
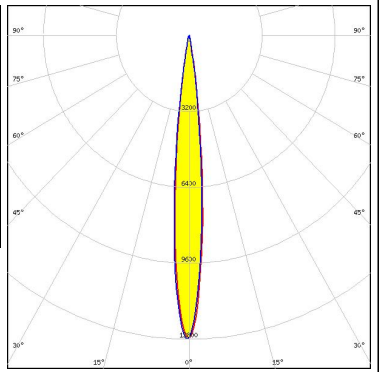
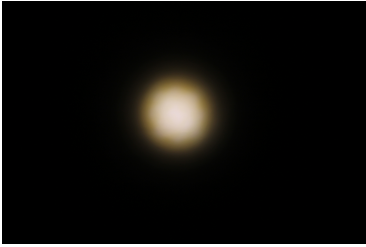
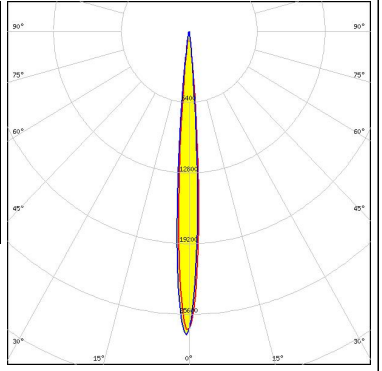

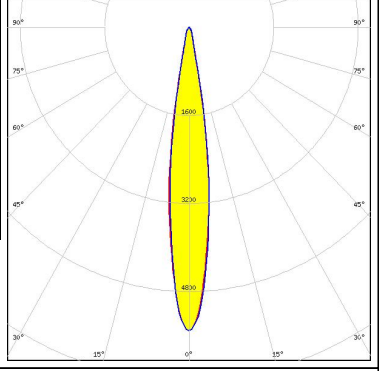
PHOTOMETRIC DATA (MEASURED):

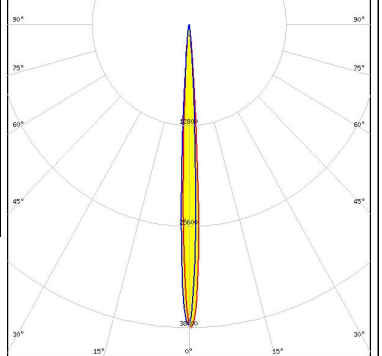
<p>LUMILEDS</p> <p>LED LUXEON CX Plus CoB M02 / M03 (Gen2)</p> <p>FWHM / FWTM 11.0° / 20.0°</p> <p>Efficiency 62 %</p> <p>Peak intensity 12.8 cd/lm</p> <p>LEDs/each optic 1</p> <p>Light colour White</p> <p>Required components: Bender Wirth: 641a Hekla</p>		
<p>LUMILEDS</p> <p>LED LUXEON CX Plus CoB S01 (Gen2)</p> <p>FWHM / FWTM 8.0° / 14.0°</p> <p>Efficiency 66 %</p> <p>Peak intensity 27.5 cd/lm</p> <p>LEDs/each optic 1</p> <p>Light colour White</p> <p>Required components: Bender Wirth: 634c Hekla</p>		
<p>LUMINUS</p> <p>LED CxM-11 (19x19)</p> <p>FWHM / FWTM 15.0° / 26.0°</p> <p>Efficiency 56 %</p> <p>Peak intensity 5.5 cd/lm</p> <p>LEDs/each optic 1</p> <p>Light colour White</p> <p>Required components: F15859_HEKLA-SOCKET-I</p>		
<p>LUMINUS</p> <p>LED CXM-3</p> <p>FWHM / FWTM 6.0° / 11.0°</p> <p>Efficiency 66 %</p> <p>Peak intensity 38.5 cd/lm</p> <p>LEDs/each optic 1</p> <p>Light colour White</p> <p>Required components: F15255_HEKLA-SOCKET-C</p>		

PHOTOMETRIC DATA (MEASURED):



LED CXM-4
 FWHM / FWTM 7.0° / 13.0°
 Efficiency 63 %
 Peak intensity 28.1 cd/lm
 LEDs/each optic 1
 Light colour White
 Required components:
 F15255_HEKLA-SOCKET-C

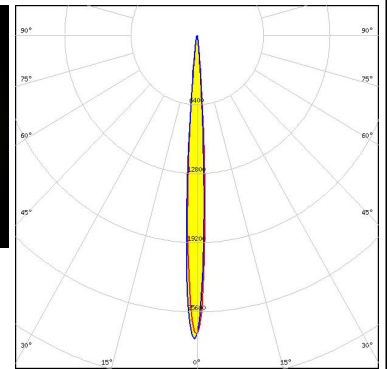

LED CxM-9 (13.5x13.5)
 FWHM / FWTM 13.0° / 21.0°
 Efficiency 59 %
 Peak intensity 9.3 cd/lm
 LEDs/each optic 1
 Light colour White
 Required components:
 F15255_HEKLA-SOCKET-C

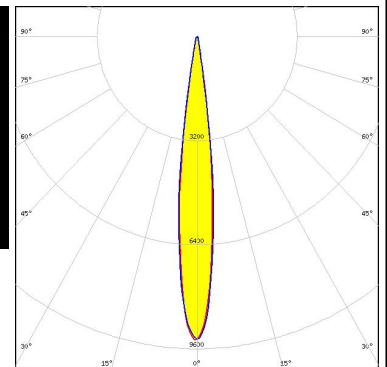

LED Fortimo SLM L09 CoB
 FWHM / FWTM 13.0° / 21.0°
 Efficiency 63 %
 Peak intensity 9.6 cd/lm
 LEDs/each optic 1
 Light colour White
 Required components:
 F15858_HEKLA-SOCKET-H

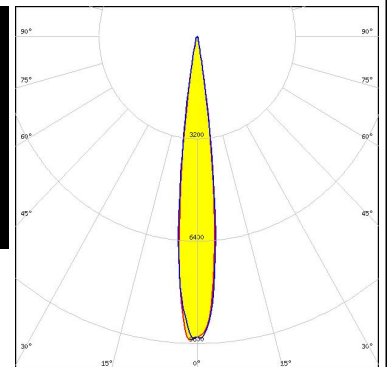

LED LC003D / LC006D / LC009D / LC013D
 FWHM / FWTM 13.0° / 21.0°
 Efficiency 60 %
 Peak intensity 9.3 cd/lm
 LEDs/each optic 1
 Light colour White
 Required components:
 F15255_HEKLA-SOCKET-C

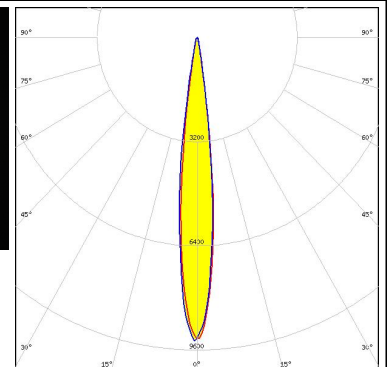
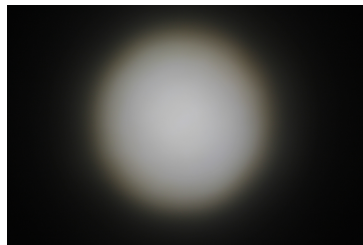

PHOTOMETRIC DATA (MEASURED):

SAMSUNG

LED LC020C
 FWHM / FWTM 11.0° / 19.0°
 Efficiency 61 %
 Peak intensity 12 cd/lm
 LEDs/each optic 1
 Light colour White
 Required components:
 F15848_HEKLA-SOCKET-G

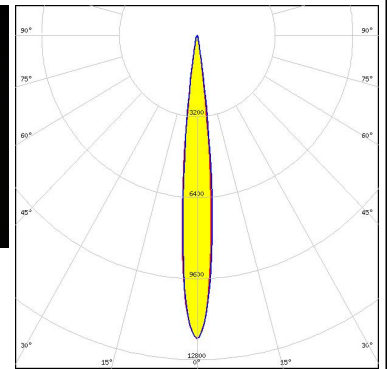

SAMSUNG

LED LC020C G2
 FWHM / FWTM 12.0° / 20.0°
 Efficiency 59 %
 Peak intensity 10 cd/lm
 LEDs/each optic 1
 Light colour White
 Required components:
 F15859_HEKLA-SOCKET-I

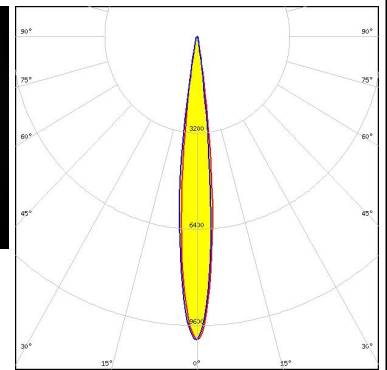

TRIDONIC

LED SLE G7 LES09
 FWHM / FWTM 12.0° / 19.0°
 Efficiency 61 %
 Peak intensity 10.9 cd/lm
 LEDs/each optic 1
 Light colour White
 Required components:
 F15255_HEKLA-SOCKET-C

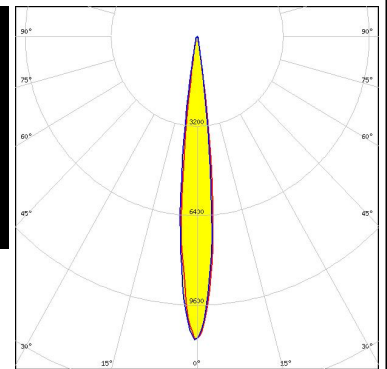
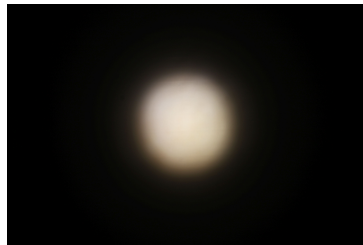

TRIDONIC

LED SLE G7 LES13
 FWHM / FWTM 17.0° / 28.0°
 Efficiency 56 %
 Peak intensity 5 cd/lm
 LEDs/each optic 1
 Light colour White
 Required components:
 F15859_HEKLA-SOCKET-I

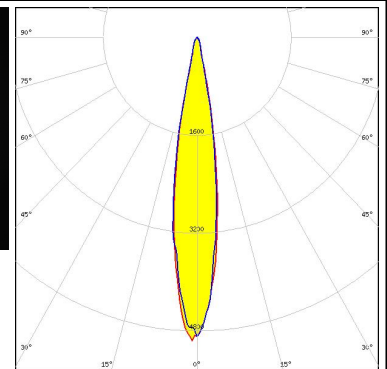
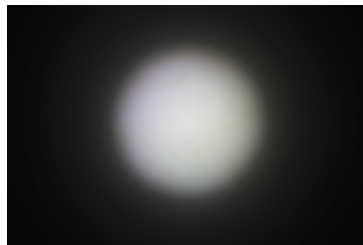

PHOTOMETRIC DATA (MEASURED):

XICATO

LED XOB 6 mm
 FWHM / FWTM 9.0° / 15.0°
 Efficiency 62 %
 Peak intensity 20.1 cd/lm
 LEDs/each optic 1
 Light colour White
 Required components:
 F15255_HEKLA-SOCKET-C

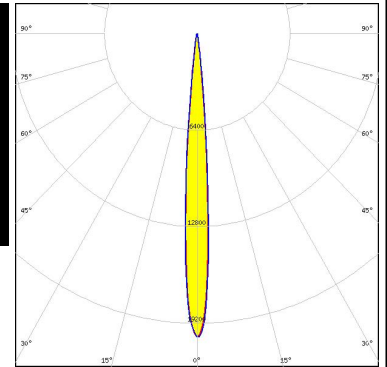
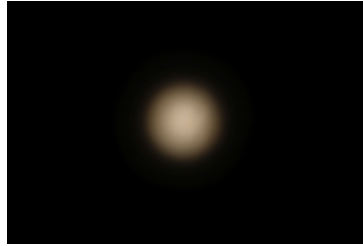

XICATO

LED XOB 9.8 mm
 FWHM / FWTM 12.0° / 20.0° + 20.5°
 Efficiency 60 %
 Peak intensity 10.4 cd/lm
 LEDs/each optic 1
 Light colour White
 Required components:
 F15255_HEKLA-SOCKET-C

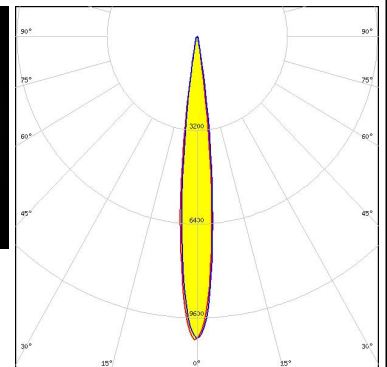
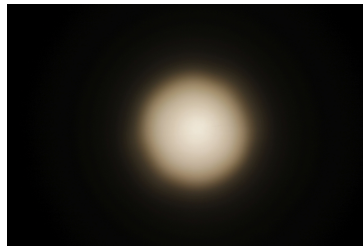

XICATO

LED XTM - 19mm LES
 FWHM / FWTM 18.0° / 38.0°
 Efficiency 50 %
 Peak intensity 2.9 cd/lm
 LEDs/each optic 1
 Light colour White
 Required components:
 C16058_XTM-ADAPTER-50-C

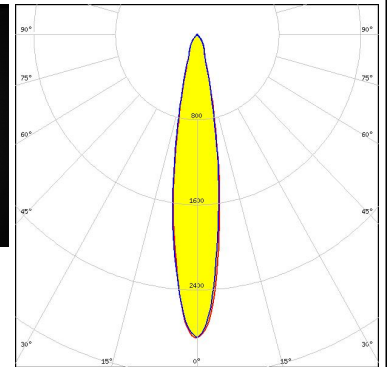

PHOTOMETRIC DATA (SIMULATED):

bridgelux

LED VERO13
 FWHM / FWTM 15.0° / 30.0°
 Efficiency 61 %
 Peak intensity 5.3 cd/lm
 LEDs/each optic 1
 Light colour White
 Required components:
 C16142_HEKLA-SOCKET-K

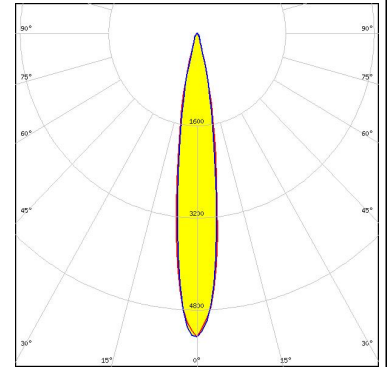

CITIZEN

LED CLL02x/CLU02x (LES10)
 FWHM / FWTM 14.0° / 24.0°
 Efficiency 45 %
 Peak intensity 7.3 cd/lm
 LEDs/each optic 1
 Light colour White
 Required components:
 F15859_HEKLA-SOCKET-I
 C16752_CARMEN-70-SHD

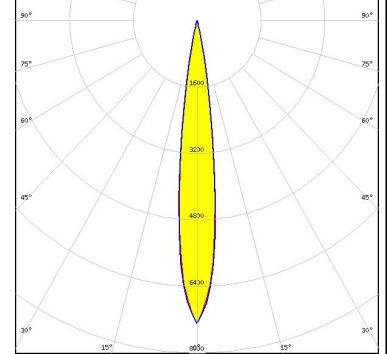

CITIZEN

LED CLU700/701/702
 FWHM / FWTM 9.0° / 16.0°
 Efficiency 51 %
 Peak intensity 17.5 cd/lm
 LEDs/each optic 1
 Light colour White
 Required components:
 F15255_HEKLA-SOCKET-C
 C16752_CARMEN-70-SHD

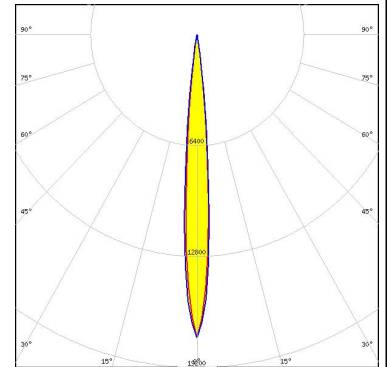

CITIZEN

LED CLU712
 FWHM / FWTM 12.0° / 22.0°
 Efficiency 64 %
 Peak intensity 10.8 cd/lm
 LEDs/each optic 1
 Light colour White
 Required components:
 F15859_HEKLA-SOCKET-I

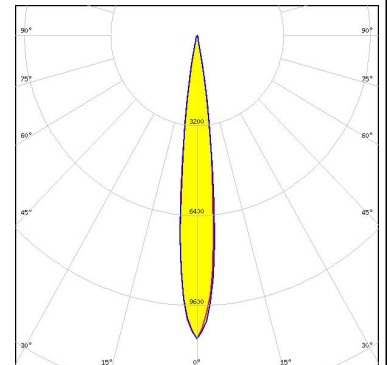

PHOTOMETRIC DATA (SIMULATED):

CITIZEN

LED CLU712
 FWHM / FWTM 13.0° / 22.0°
 Efficiency 47 %
 Peak intensity 8.7 cd/lm
 LEDs/each optic 1
 Light colour White
 Required components:
 F15859_HEKLA-SOCKET-I
 C16752_CARMEN-70-SHD

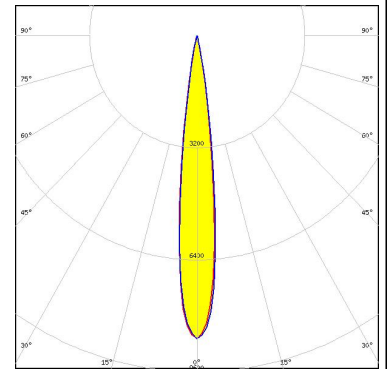

CITIZEN

LED CLU720/721
 FWHM / FWTM 15.0° / 29.0°
 Efficiency 61 %
 Peak intensity 6.6 cd/lm
 LEDs/each optic 1
 Light colour White
 Required components:
 F15859_HEKLA-SOCKET-I

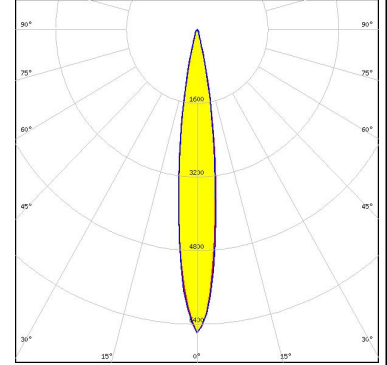

CITIZEN

LED CLU7A2 (LES 4.2mm)
 FWHM / FWTM 8.0° / 14.0°
 Efficiency 52 %
 Peak intensity 25.9 cd/lm
 LEDs/each optic 1
 Light colour White
 Required components:
 F15255_HEKLA-SOCKET-C
 C16752_CARMEN-70-SHD

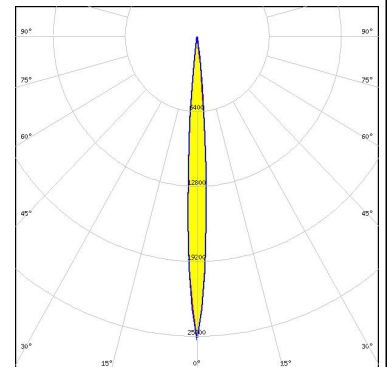

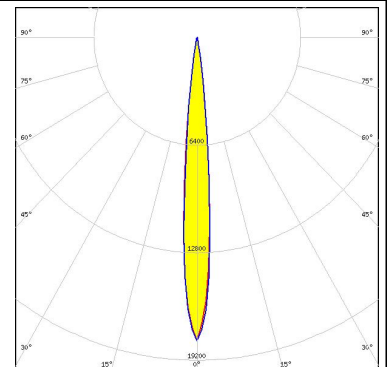

LUMILEDS

LED LUXEON CoB Compact
 FWHM / FWTM 10.0° / 18.0°
 Efficiency 71 %
 Peak intensity 18 cd/lm
 LEDs/each optic 1
 Light colour White
 Required components:
 F15848_HEKLA-SOCKET-G

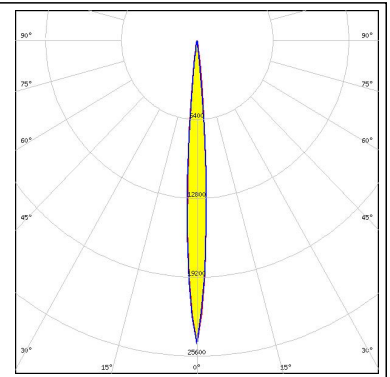
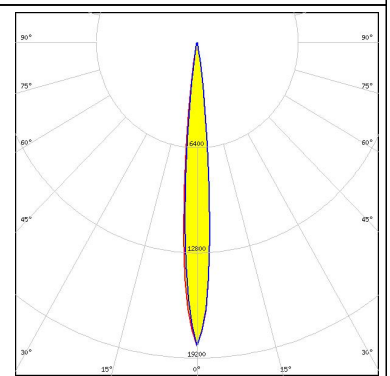
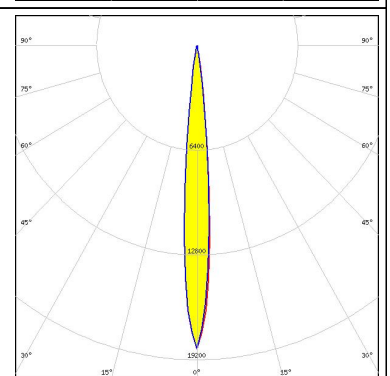
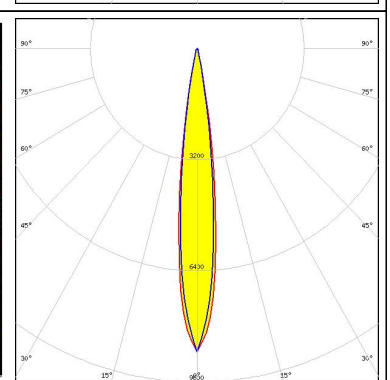

PHOTOMETRIC DATA (SIMULATED):

<p>LUMINUS</p> <p>LED CXM-4 FWHM / FWTM 8.0° / 14.0° Efficiency 52 % Peak intensity 24.6 cd/lm LEDs/each optic 1 Light colour White Required components: F17435_HEKLA-G2-C C16752_CARMEN-70-SHD</p>	
<p>LUMINUS</p> <p>LED CxM-6 (12x13) FWHM / FWTM 10.0° / 18.0° Efficiency 68 % Peak intensity 18.5 cd/lm LEDs/each optic 1 Light colour White Required components: F15255_HEKLA-SOCKET-C</p>	
<p>LUMINUS</p> <p>LED CxM-6 (13.5x13.5) FWHM / FWTM 10.0° / 18.0° Efficiency 68 % Peak intensity 18.5 cd/lm LEDs/each optic 1 Light colour White Required components: F17435_HEKLA-G2-C</p>	
<p>SAMSUNG</p> <p>LED LC003D / LC006D / LC009D / LC013D FWHM / FWTM 13.0° / 24.0° Efficiency 62 % Peak intensity 8.7 cd/lm LEDs/each optic 1 Light colour White Required components: F17435_HEKLA-G2-C</p>	 

PHOTOMETRIC DATA (SIMULATED):

SAMSUNG

LED LC003D / LC006D / LC009D / LC013D
FWHM / FWTM 14.0° / 24.0°
Efficiency 62 %
Peak intensity 8.5 cd/lm
LEDs/each optic 1
Light colour White
Required components:
F17435_HEKLA-G2-C

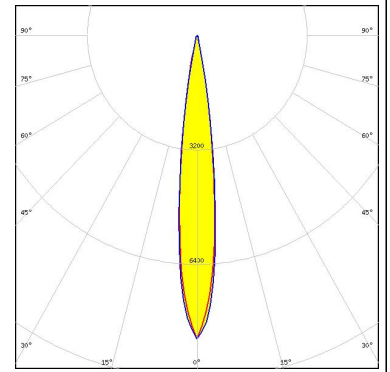

SAMSUNG

LED LC010C
FWHM / FWTM 10.0° / 18.0°
Efficiency 68 %
Peak intensity 18.6 cd/lm
LEDs/each optic 1
Light colour White
Required components:
F17435_HEKLA-G2-C

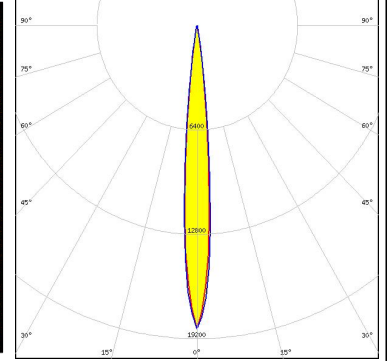

GENERAL INFORMATION:

NOTE: The typical beam angle will be changed by different color, chip size and chip position tolerance. The typical total beam angle is the full angle measured where the luminous intensity is half of the peak value.

Due to use of high power COB's with this product, special attention to proper thermal design is highly recommended. LEDiL has no liability for direct, indirect or consecutive damages arising from the LEDiL products being used outside of the recommended temperature range.

MATERIALS:

As part of our continuous research and improvement processes, and to ensure the best possible quality and availability of our products, LEDiL reserves the right to change material grades without notice.

PRODUCT DATA USER AGREEMENT AND DISCLAIMER:

The measured data in the provided downloadable LEDiL Product Datasheets and Mechanical 2D-Drawings is rounded and provided as reference for planning. LEDiL Oy's optical specifications have been verified by conducting performance testing of the products in accordance with the company's quality system. The reported data are averaged results of multiple measurements with typical variation. LEDiL Oy reserves the right to without prior notification make changes and improvements to its products.

LEDiL Oy assumes neither warranty, nor guarantee nor any other liability of any kind for the contents and correctness of the provided data. The provided data has been generated with highest diligence but the provided data may in reality not represent the complete possible variation range of all intrinsic parameters. Therefore, in certain cases a deviation from the provided data could occur.

LEDiL Oy reserves the right to undertake technical changes of its products without further notification which could lead to changes in the provided data. LEDiL Oy assumes no liability of any kind for the possible deviation from any provided data or any other damage resulting from the usage of the provided data.

The user agrees to this disclaimer and user agreement with the download or usage of the provided files.

LEDiL Oy

Joensuunkatu 13
FI-24240 SALO
Finland

LEDiL Inc.

228 West Page Street
Suite D
Sycamore IL 60178
USA

Ledil Optics Technology (Shenzhen) Co., Ltd.

405 , Block B
Casic Motor Building
Shenzhen 518057
P.R.CHINA

Local sales and technical support

[www.ledil.com/
where_to_buy](http://www.ledil.com/where_to_buy)

Shipping locations

Salo, Finland
Hong Kong, China

Distribution Partners

[www.ledil.com/
where_to_buy](http://www.ledil.com/where_to_buy)

X-ON Electronics

Largest Supplier of Electrical and Electronic Components

Click to view similar products for [LED Lighting Lenses Assemblies](#) category:

Click to view products by [Ledil](#) manufacturer:

Other Similar products are found below :

[FCN12592_LE1-D-COP](#) [CA16129_OLGA-W](#) [CA16370_HB-SQ-W](#) [FN15972_RONDA-ZT45-C](#) [CS15759_HB-2X2MX-8-W](#)
[CA16435_LXP2-SS-WAS](#) [CN16210_GABRIELLA-MIDI-W](#) [CP17137_CARMEN-M2-C](#) [CA16015_STRADA-SQ-SCL](#) [CP17594_TINA-SC-](#)
[RS](#) [CS15767_HB-2X2MX-8-M](#) [CP10960_RGBX-SS](#) [CP12395_LXP3-W](#) [CP12939_LARISA-RS-CLIP16](#) [C14636_XTM-PF-ADAPTER](#)
[CA11819_STRADA-SQ-T-DW](#) [CA14508_G2-LXP2-D](#) [CA14601_VERONICA-SQ-MINI-RS](#) [FCP13895_SEANNA-A](#) [CP12943_LARISA-](#)
[O-CLIP16](#) [FP11124_LISA2-O-PIN](#) [CS14597_HB-IP-2X6-O](#) [CP14995_FLORENTINA-HLD-O](#) [CS15158_STRADA-IP-2X6-T4-B](#)
[CS16323_STRADELLA-IP-28-HB-M](#) [FN14976_STELLA-DWC2](#) [FN15264_STELLA-HB-WWW](#) [CA15584_ZORYA-MINI-TAPE](#)
[FA15229_ROSE-MRK-S](#) [FA15232_ROSE-MRK-M](#) [FA15233_ROSE-MRK-W](#) [FCN13552_CRYSTAL-RS](#) [FN15552_RONDA-W](#)
[FS15626_FLORENCE-3R-IP-Z90](#) [FS15786_FLORENCE-3R-IP-Z60](#) [FS15847_FLORENCE-3R-IP-O](#) [CA14505_G2-LXP2-RS2-P](#)
[FCN12775_IRIS-O](#) [CP15304_LARISA-RS-PIN](#) [FN15679_RONDA-S](#) [CA15519_VERONICA-SQ-MINI-D](#) [FP14414_LISA2-O-PIN](#)
[LL01CR-DF60L06-M2](#) [FN15993_RONDA-O](#) [FN15977_RONDA-WAS2](#) [CA14366_FLARE-MAXI-TAPE](#) [CA14442_VERONICA-SQ-W](#)
[CA14509_G2-LXP2-M-P](#) [CA15231_VERONICA-SQ-MINI-W](#) [FP11002_LISA2-W-PIN](#)