

CARMEN-50-RS-C

~12° spot beam. Assembly with holder C compatible with LEDiL HEKLA.

TECHNICAL SPECIFICATIONS:

Dimensions	Ø 50.0 mm
Height	25.5 mm
Fastening	socket
ROHS compliant	yes ⓘ

MATERIAL SPECIFICATIONS:

Component	Type	Material	Colour	Finish
CARMEN-50-RS	Single lens	PMMA	clear	
CARMEN-50-HLD-C	Holder	PC	black	

ORDERING INFORMATION:



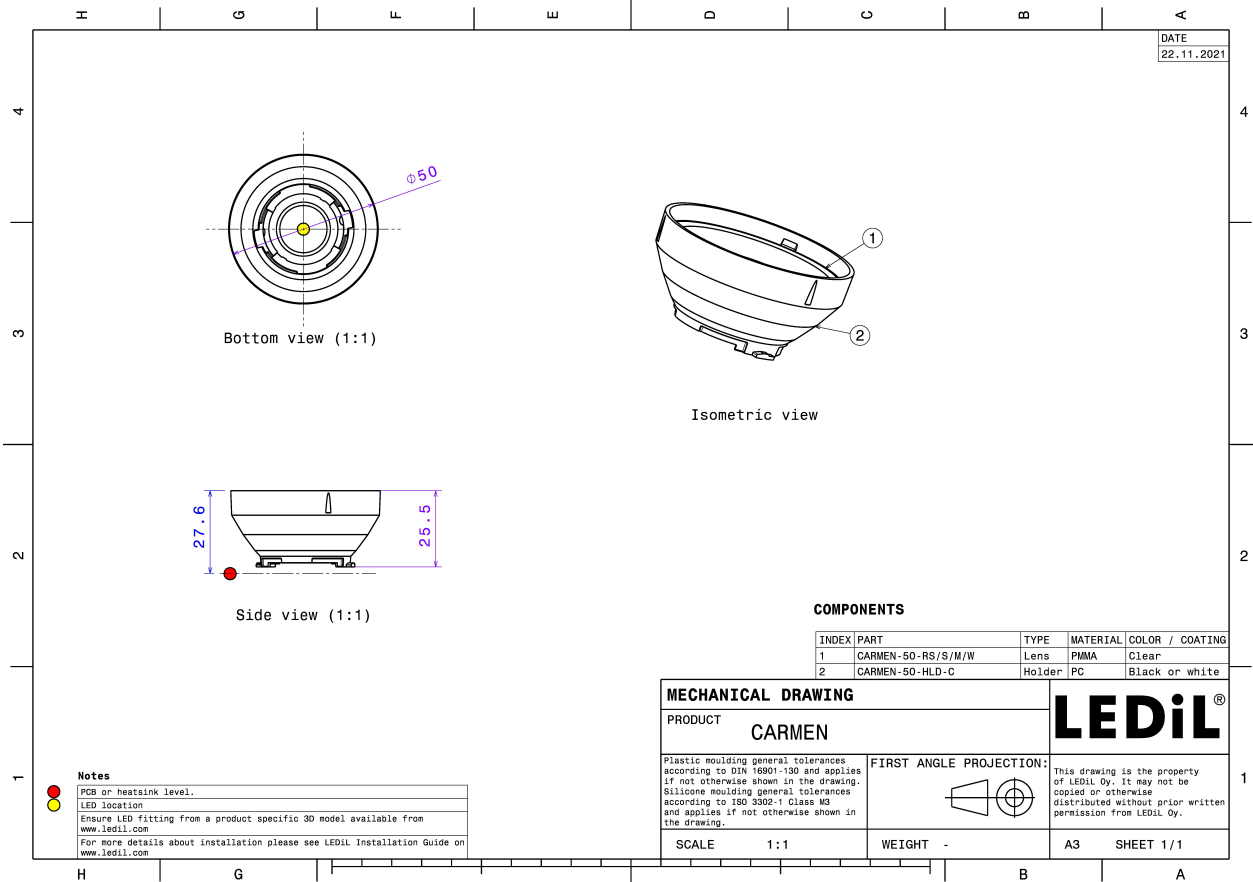

Component	Type	Qty in box	MOQ	MPQ	Box weight (kg)
CP16106_CARMEN-50-RS-C » Box size: 476 x 273 x 292 mm	Single lens	308	112	28	7.2



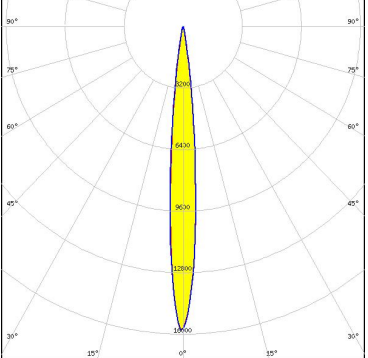

See also our general installation guide: www.ledil.com/installation_guide

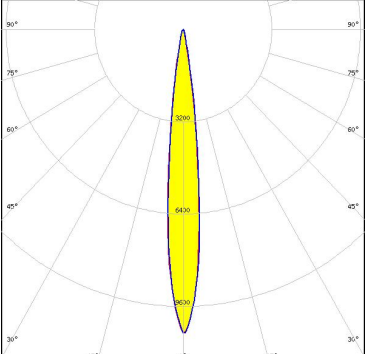
PHOTOMETRIC DATA (MEASURED):

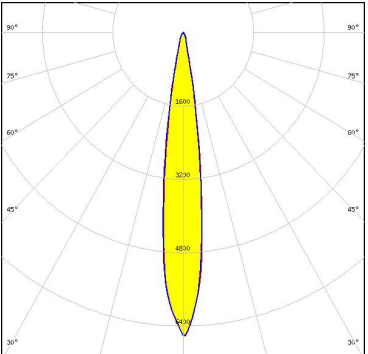
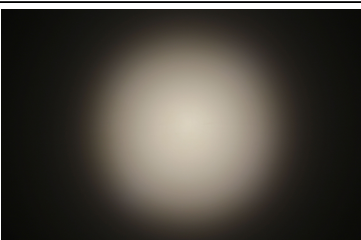
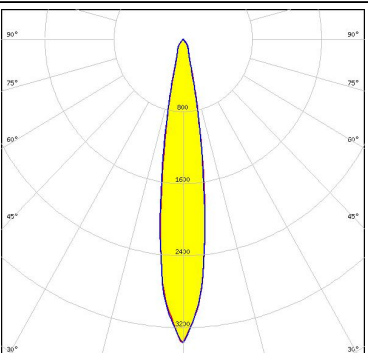
<p>bridgelux.</p> <p>LED V4 HD</p> <p>FWHM / FWTM 10.0° / 19.0°</p> <p>Efficiency 71 %</p> <p>Peak intensity 16 cd/lm</p> <p>LEDs/each optic 1</p> <p>Light colour White</p> <p>Required components: F15253_HEKLA-SOCKET-A</p>		
<p>bridgelux.</p> <p>LED V6 HD</p> <p>FWHM / FWTM 12.0° / 22.0°</p> <p>Efficiency 68 %</p> <p>Peak intensity 10.6 cd/lm</p> <p>LEDs/each optic 1</p> <p>Light colour White</p> <p>Required components: F15255_HEKLA-SOCKET-C</p>		
<p>bridgelux.</p> <p>LED V9 HD</p> <p>FWHM / FWTM 15.0° / 26.0°</p> <p>Efficiency 64 %</p> <p>Peak intensity 6.7 cd/lm</p> <p>LEDs/each optic 1</p> <p>Light colour White</p> <p>Required components: F15859_HEKLA-SOCKET-I</p>		
<p>bridgelux.</p> <p>LED VERO13</p> <p>FWHM / FWTM 17.0° / 33.0°</p> <p>Efficiency 51 %</p> <p>Peak intensity 3.4 cd/lm</p> <p>LEDs/each optic 1</p> <p>Light colour White</p> <p>Required components: C16142_HEKLA-SOCKET-K</p>		

PHOTOMETRIC DATA (MEASURED):

bridgelux.

LED Vesta TW 6mm DP
 FWHM / FWTM 11.0° / 21.0°
 Efficiency 59 %
 Peak intensity 9.9 cd/lm
 LEDs/each optic 1
 Light colour White

Required components:
 C16142_HEKLA-SOCKET-K
 Bender Wirth: 504 Typ L8



bridgelux.

LED Vesta TW 9mm (9W) DP
 FWHM / FWTM 15.0° / 28.0°
 Efficiency 54 %
 Peak intensity 5.1 cd/lm
 LEDs/each optic 1
 Light colour White

Required components:
 C16142_HEKLA-SOCKET-K
 Bender Wirth: 489 Typ L8



CITIZEN

LED CLL02x/CLU02x (LES10)
 FWHM / FWTM 16.0° / 29.0°
 Efficiency 63 %
 Peak intensity 5.6 cd/lm
 LEDs/each optic 1
 Light colour White

Required components:
 F15255_HEKLA-SOCKET-C



CITIZEN

LED CLU700/701/702
 FWHM / FWTM 11.0° / 21.0°
 Efficiency 67 %
 Peak intensity 11.8 cd/lm
 LEDs/each optic 1
 Light colour White

Required components:
 F15255_HEKLA-SOCKET-C



PHOTOMETRIC DATA (MEASURED):

CITIZEN

LED CLU710/711
 FWHM / FWTM 14.0° / 27.0°
 Efficiency 62 %
 Peak intensity 6.4 cd/lm
 LEDs/each optic 1
 Light colour White
 Required components:
 F15859_HEKLA-SOCKET-I

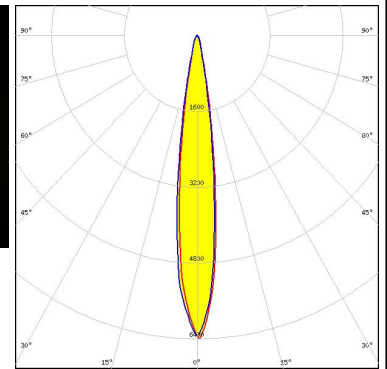

CITIZEN

LED CLU7A2 (LES 4.2mm)
 FWHM / FWTM 9.0° / 18.0°
 Efficiency 72 %
 Peak intensity 18.5 cd/lm
 LEDs/each optic 1
 Light colour White
 Required components:
 F15255_HEKLA-SOCKET-C

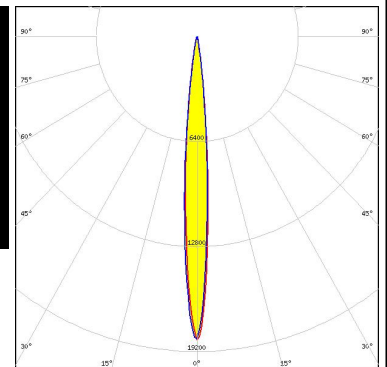

CITIZEN

LED CLU7B2
 FWHM / FWTM 8.0° / 17.0°
 Efficiency 71 %
 Peak intensity 20 cd/lm
 LEDs/each optic 1
 Light colour White
 Required components:
 F15255_HEKLA-SOCKET-C

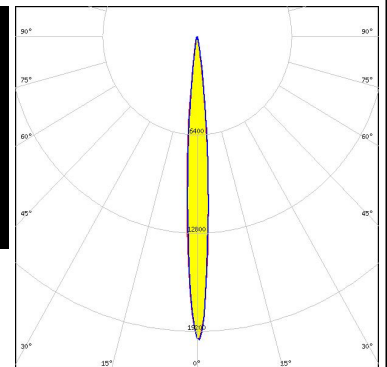
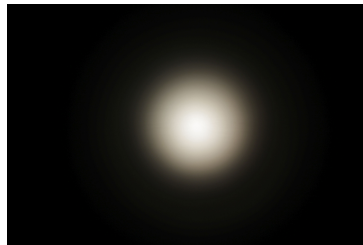





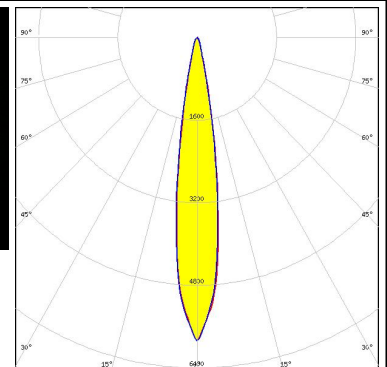
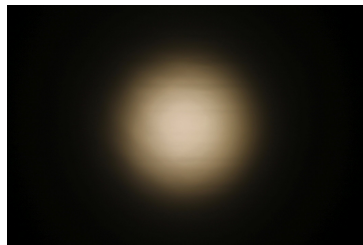

CREE LED

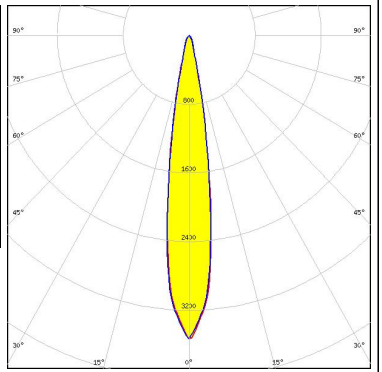

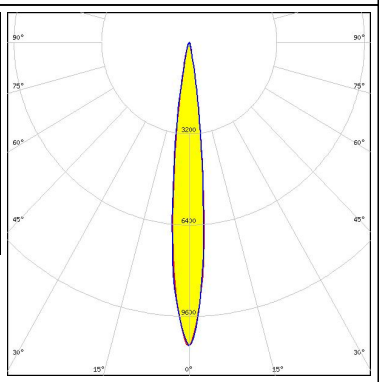

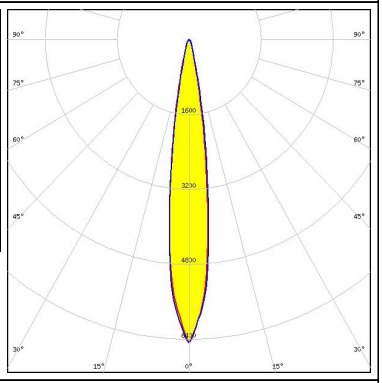
LED CMA1516
 FWHM / FWTM 16.0° / 29.0°
 Efficiency 65 %
 Peak intensity 5.9 cd/lm
 LEDs/each optic 1
 Light colour White
 Required components:
 F15256_HEKLA-SOCKET-D

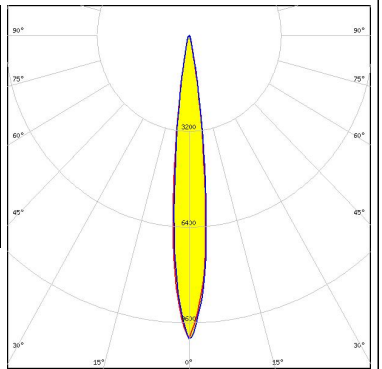



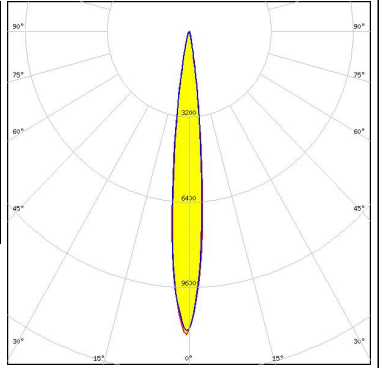
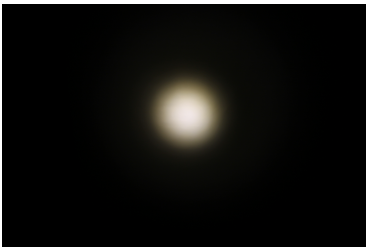
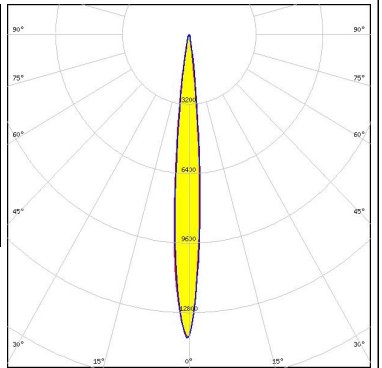

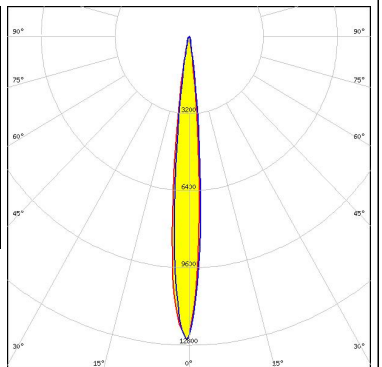

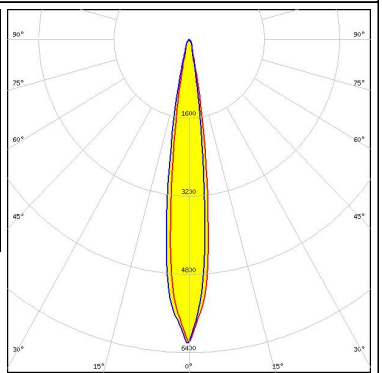
PHOTOMETRIC DATA (MEASURED):

<p>CREE LED</p> <p>LED CMT14xx FWHM / FWTM 16.0° / 30.0° Efficiency 42 % Peak intensity 3.6 cd/lm LEDs/each optic 1 Light colour White Required components: F15255_HEKLA-SOCKET-C</p>		
<p>CREE LED</p> <p>LED CXA/B 13xx FWHM / FWTM 12.0° / 23.0° Efficiency 68 % Peak intensity 10.6 cd/lm LEDs/each optic 1 Light colour White Required components: F15956_HEKLA-SOCKET-J</p>		
<p>CREE LED</p> <p>LED CXA/B 15xx FWHM / FWTM 15.0° / 28.0° Efficiency 65 % Peak intensity 6.5 cd/lm LEDs/each optic 1 Light colour White Required components: F15256_HEKLA-SOCKET-D</p>		
<p>LUMILEDS</p> <p>LED LUXEON CoB 1202HD FWHM / FWTM 12.0° / 23.0° Efficiency 68 % Peak intensity 10.1 cd/lm LEDs/each optic 1 Light colour White Required components: F15848_HEKLA-SOCKET-G</p>		

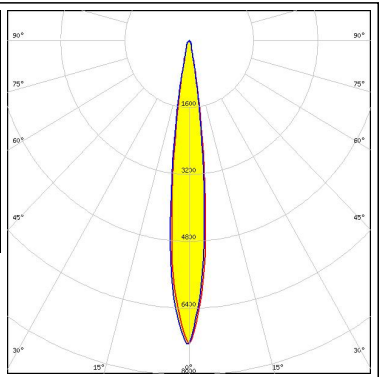

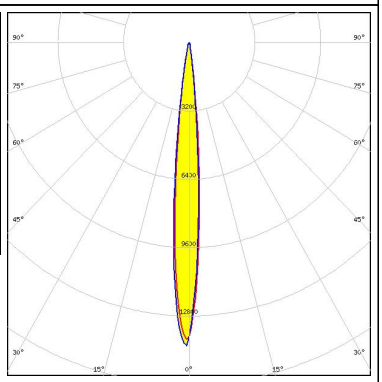

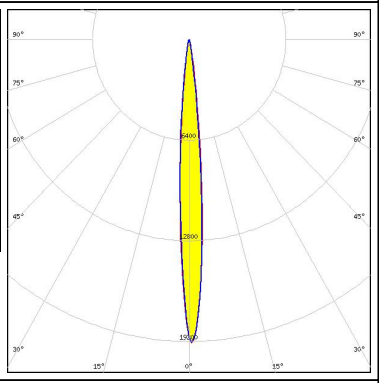
PHOTOMETRIC DATA (MEASURED):

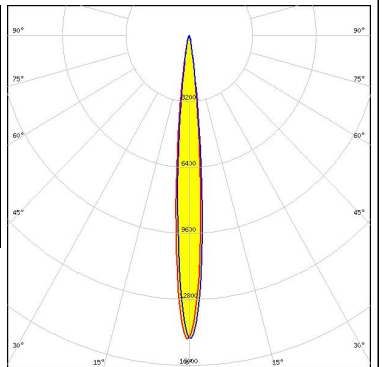
<p>LUMILEDS</p> <p>LED LUXEON CoB 1202s</p> <p>FWHM / FWTM 12.0° / 22.0°</p> <p>Efficiency 69 %</p> <p>Peak intensity 11.4 cd/lm</p> <p>LEDs/each optic 1</p> <p>Light colour White</p> <p>Required components: F15848_HEKLA-SOCKET-G</p>		
<p>LUMILEDS</p> <p>LED LUXEON CX Plus CoB - HD S01H4</p> <p>FWHM / FWTM 10.0° / 19.0°</p> <p>Efficiency 64 %</p> <p>Peak intensity 14 cd/lm</p> <p>LEDs/each optic 1</p> <p>Light colour White</p> <p>Required components: Bender Wirth: 634c Hekla</p>		
<p>LUMILEDS</p> <p>LED LUXEON CX Plus CoB - HD S01H6 / HD S02H6</p> <p>FWHM / FWTM 10.0° / 19.0°</p> <p>Efficiency 64 %</p> <p>Peak intensity 12.7 cd/lm</p> <p>LEDs/each optic 1</p> <p>Light colour White</p> <p>Required components: Bender Wirth: 634c Hekla</p>		
<p>LUMILEDS</p> <p>LED LUXEON CX Plus CoB - HD S04H9</p> <p>FWHM / FWTM 14.0° / 26.0°</p> <p>Efficiency 60 %</p> <p>Peak intensity 6.2 cd/lm</p> <p>LEDs/each optic 1</p> <p>Light colour White</p> <p>Required components: Bender Wirth: 634c Hekla</p>		

PHOTOMETRIC DATA (MEASURED):

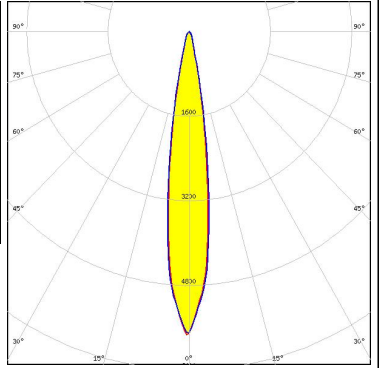
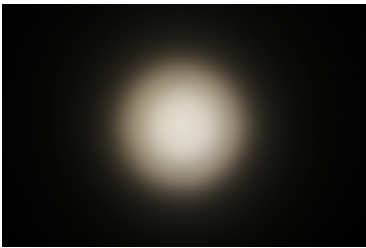
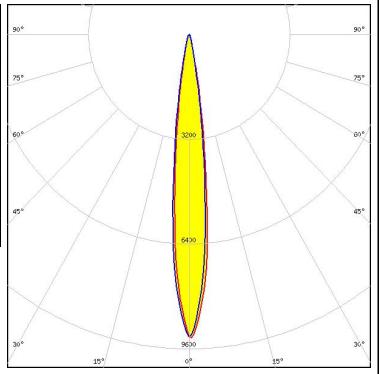
<p>LUMILEDS</p> <p>LED LUXEON CX Plus CoB M02 / M03 (Gen2)</p> <p>FWHM / FWTM 13.0° / 25.0°</p> <p>Efficiency 60 %</p> <p>Peak intensity 7.3 cd/lm</p> <p>LEDs/each optic 1</p> <p>Light colour White</p> <p>Required components: Bender Wirth: 641a Hekla</p>		
<p>LUMILEDS</p> <p>LED LUXEON CX Plus CoB S01 (Gen2)</p> <p>FWHM / FWTM 10.0° / 19.0°</p> <p>Efficiency 65 %</p> <p>Peak intensity 14.3 cd/lm</p> <p>LEDs/each optic 1</p> <p>Light colour White</p> <p>Required components: Bender Wirth: 634c Hekla</p>		
<p>LUMINUS</p> <p>LED CXM-3</p> <p>FWHM / FWTM 9.0° / 17.0°</p> <p>Efficiency 72 %</p> <p>Peak intensity 19.8 cd/lm</p> <p>LEDs/each optic 1</p> <p>Light colour White</p> <p>Required components: F15255_HEKLA-SOCKET-C</p>		
<p>LUMINUS</p> <p>LED CXM-4</p> <p>FWHM / FWTM 10.0° / 19.0°</p> <p>Efficiency 68 %</p> <p>Peak intensity 14.8 cd/lm</p> <p>LEDs/each optic 1</p> <p>Light colour White</p> <p>Required components: F15255_HEKLA-SOCKET-C</p>		

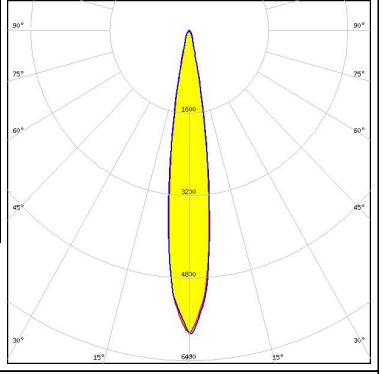
PHOTOMETRIC DATA (MEASURED):

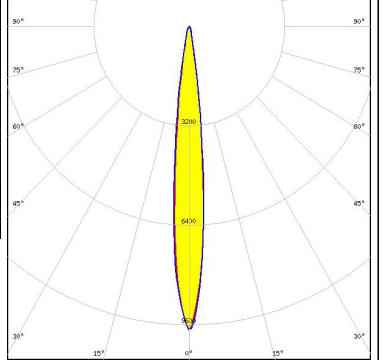
<p>LUMINUS</p> <p>LED CxM-9 (13.5x13.5) FWHM / FWTM 15.0° / 29.0° Efficiency 63 % Peak intensity 5.8 cd/lm LEDs/each optic 1 Light colour White Required components: F15255_HEKLA-SOCKET-C</p>		
<p>NICHIA</p> <p>LED COB S-Type (LES 7) FWHM / FWTM 13.0° / 24.0° Efficiency 67 % Peak intensity 9.3 cd/lm LEDs/each optic 1 Light colour White Required components: F15848_HEKLA-SOCKET-G</p>		
<p>PHILIPS</p> <p>LED Fortimo SLM L09 CoB FWHM / FWTM 15.0° / 28.0° Efficiency 64 % Peak intensity 6 cd/lm LEDs/each optic 1 Light colour White Required components: F15858_HEKLA-SOCKET-H</p>		
<p>SAMSUNG</p> <p>LED LC010C FWHM / FWTM 11.0° / 22.0° Efficiency 64 % Peak intensity 9.8 cd/lm LEDs/each optic 1 Light colour White Required components: F15848_HEKLA-SOCKET-G</p>		

PHOTOMETRIC DATA (MEASURED):

SAMSUNG

LED LC010C G2
 FWHM / FWTM 11.0° / 21.0°
 Efficiency 67 %
 Peak intensity 12.6 cd/lm
 LEDs/each optic 1
 Light colour White
 Required components:
 F15255_HEKLA-SOCKET-C

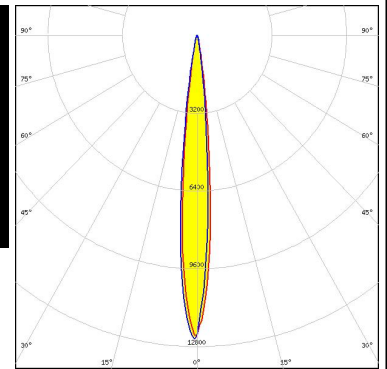
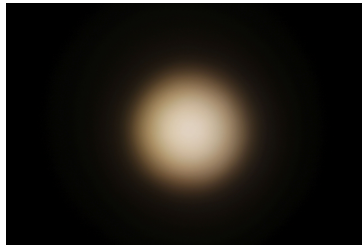

SAMSUNG

LED LC020C
 FWHM / FWTM 13.0° / 26.0°
 Efficiency 64 %
 Peak intensity 7.1 cd/lm
 LEDs/each optic 1
 Light colour White
 Required components:
 F15848_HEKLA-SOCKET-G

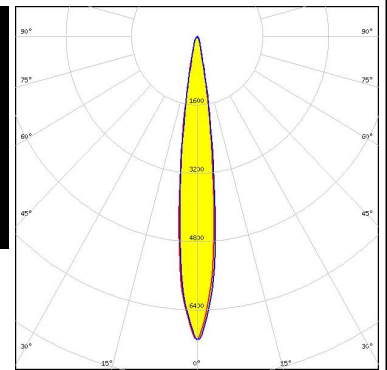

SAMSUNG

LED LC020C G2
 FWHM / FWTM 15.0° / 27.0°
 Efficiency 63 %
 Peak intensity 6.3 cd/lm
 LEDs/each optic 1
 Light colour White
 Required components:
 F15859_HEKLA-SOCKET-I

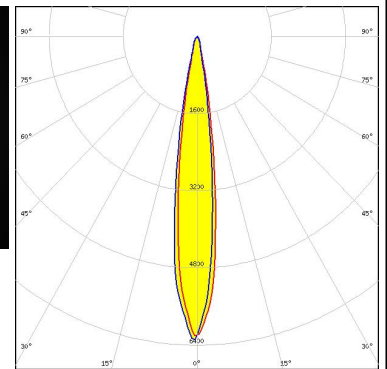
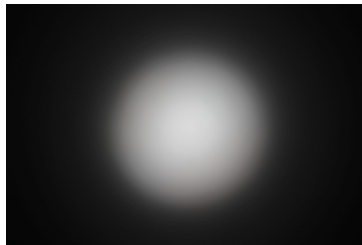

TRIDONIC

LED SLE G7 LES09
 FWHM / FWTM 15.0° / 27.0°
 Efficiency 66 %
 Peak intensity 6.5 cd/lm
 LEDs/each optic 1
 Light colour White
 Required components:
 F15255_HEKLA-SOCKET-C

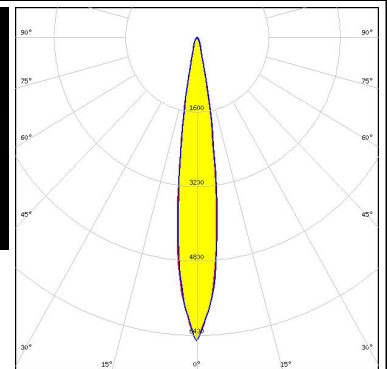
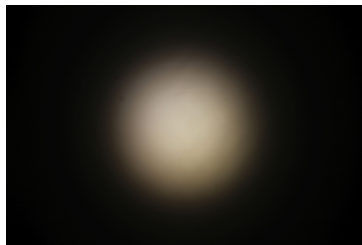

PHOTOMETRIC DATA (MEASURED):

TRIDONIC

LED SLE G7 LES13
 FWHM / FWTM 20.0° / 37.0°
 Efficiency 56 %
 Peak intensity 3 cd/lm
 LEDs/each optic 1
 Light colour White
 Required components:
 F15858_HEKLA-SOCKET-H

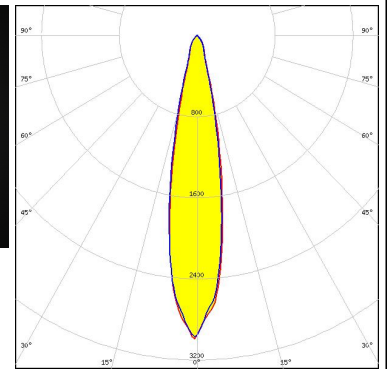

XICATO

LED XOB 6 mm
 FWHM / FWTM 11.0° / 21.0°
 Efficiency 66 %
 Peak intensity 11.1 cd/lm
 LEDs/each optic 1
 Light colour White
 Required components:
 F15255_HEKLA-SOCKET-C

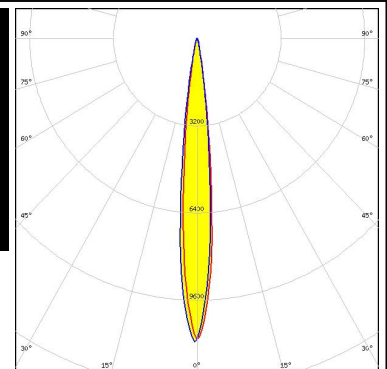

XICATO

LED XOB 9.8 mm
 FWHM / FWTM 15.0° / 28.0°
 Efficiency 63 %
 Peak intensity 6.1 cd/lm
 LEDs/each optic 1
 Light colour White
 Required components:
 F15255_HEKLA-SOCKET-C

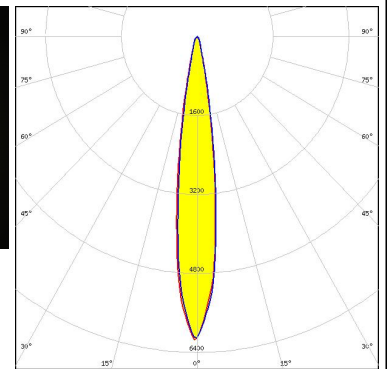





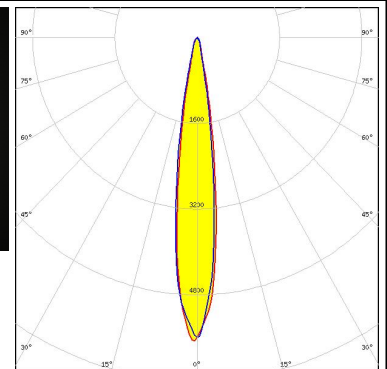
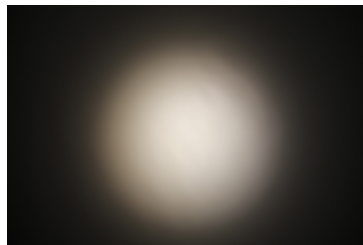

XICATO

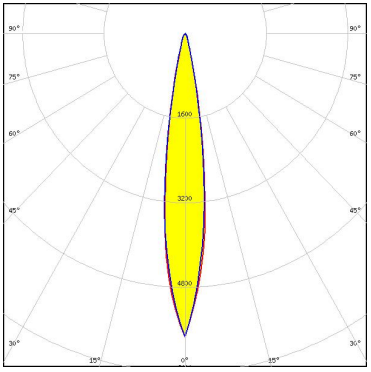
LED XTM - 9mm LES
 FWHM / FWTM 15.0° / 28.0°
 Efficiency 60 %
 Peak intensity 5.8 cd/lm
 LEDs/each optic 1
 Light colour White
 Required components:
 C15743_XTM-ADAPTER-50-B

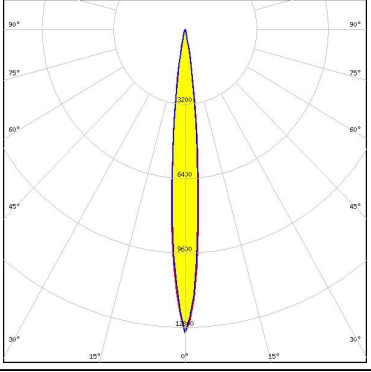

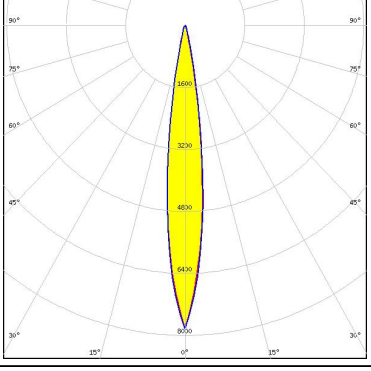
PHOTOMETRIC DATA (SIMULATED):

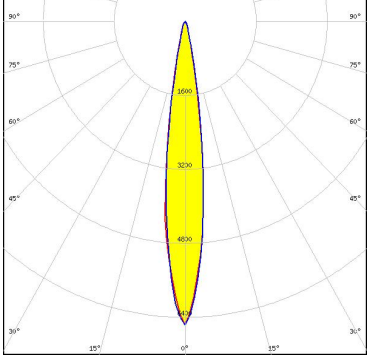
<p></p> <p>LED V10 Gen7 FWHM / FWTM 16.0° / 30.0° Efficiency 60 % Peak intensity 5.7 cd/lm LEDs/each optic 1 Light colour White Required components: F15255_HEKLA-SOCKET-C</p>	
<p></p> <p>LED V6 Gen6 FWHM / FWTM 10.0° / 21.0° Efficiency 66 % Peak intensity 13 cd/lm LEDs/each optic 1 Light colour White Required components: F15253_HEKLA-SOCKET-A</p>	
<p></p> <p>LED V8 Gen7 FWHM / FWTM 14.0° / 26.0° Efficiency 63 % Peak intensity 7.8 cd/lm LEDs/each optic 1 Light colour White Required components: F15253_HEKLA-SOCKET-A</p>	
<p></p> <p>LED VERO10 FWHM / FWTM 15.0° / 27.0° Efficiency 61 % Peak intensity 6.7 cd/lm LEDs/each optic 1 Light colour White Required components: F15616_HEKLA-SOCKET-F</p>	

PHOTOMETRIC DATA (SIMULATED):

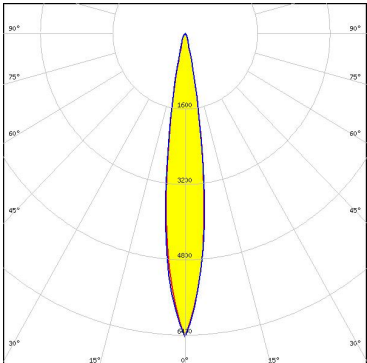
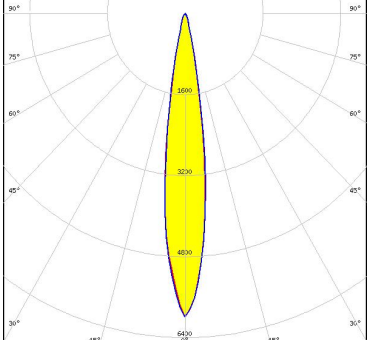
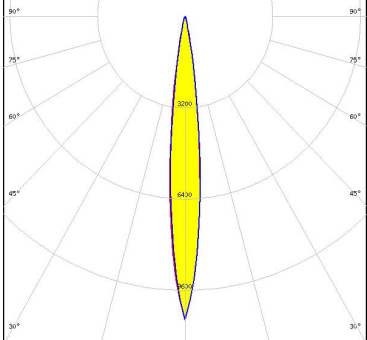
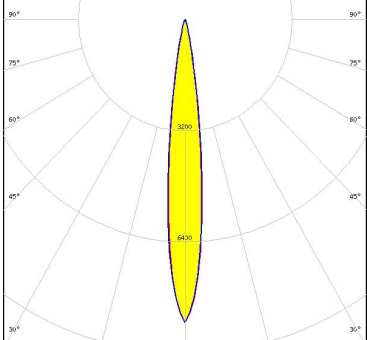
<p>LUMILEDS</p> <p>LED LUXEON CoB 1202/1203</p> <p>FWHM / FWTM 14.0° / 28.0°</p> <p>Efficiency 61 %</p> <p>Peak intensity 6.4 cd/lm</p> <p>LEDs/each optic 1</p> <p>Light colour White</p> <p>Required components: F15858_HEKLA-SOCKET-H</p>	
<p>LUMILEDS</p> <p>LED LUXEON CoB 1204HD</p> <p>FWHM / FWTM 16.0° / 28.0°</p> <p>Efficiency 61 %</p> <p>Peak intensity 6 cd/lm</p> <p>LEDs/each optic 1</p> <p>Light colour White</p> <p>Required components: F15858_HEKLA-SOCKET-H</p>	
<p>LUMINUS</p> <p>LED CxM-6 (13.5x13.5)</p> <p>FWHM / FWTM 12.0° / 23.0°</p> <p>Efficiency 65 %</p> <p>Peak intensity 10.6 cd/lm</p> <p>LEDs/each optic 1</p> <p>Light colour White</p> <p>Required components: F15255_HEKLA-SOCKET-C</p>	
<p>NICHIA</p> <p>LED COB S-Type (LES 6)</p> <p>FWHM / FWTM 13.0° / 25.0°</p> <p>Efficiency 63 %</p> <p>Peak intensity 8.7 cd/lm</p> <p>LEDs/each optic 1</p> <p>Light colour White</p> <p>Required components: F15848_HEKLA-SOCKET-G</p>	

PHOTOMETRIC DATA (SIMULATED):

OSRAM

Opto Semiconductors

LED Soleriq S9
 FWHM / FWTM 15.0° / 28.0°
 Efficiency 59 %
 Peak intensity 5.8 cd/lm
 LEDs/each optic 1
 Light colour White
 Required components:
 F15255_HEKLA-SOCKET-C

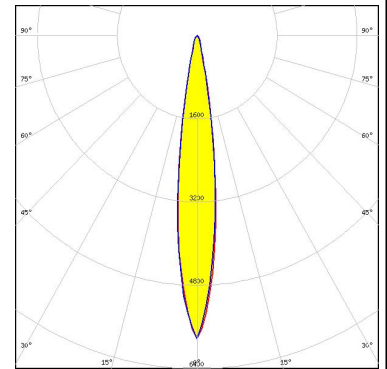

PHILIPS

LED Fortimo SLM L06 CoB
 FWHM / FWTM 10.0° / 22.0°
 Efficiency 53 %
 Peak intensity 9.6 cd/lm
 LEDs/each optic 1
 Light colour White
 Required components:
 F15858_HEKLA-SOCKET-H

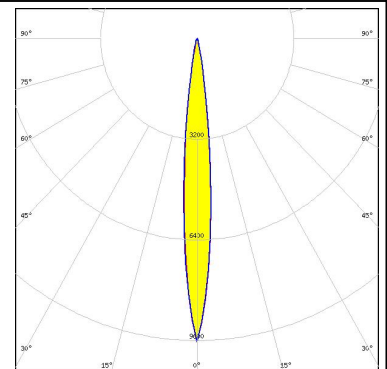

SAMSUNG

LED LC003D / LC006D / LC009D / LC013D
 FWHM / FWTM 16.0° / 30.0°
 Efficiency 58 %
 Peak intensity 5.2 cd/lm
 LEDs/each optic 1
 Light colour White
 Required components:
 F17435_HEKLA-G2-C

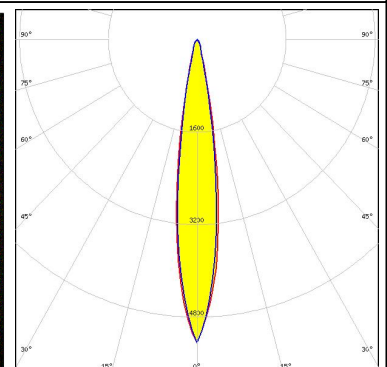

SAMSUNG

LED LC003D / LC006D / LC009D / LC013D
 FWHM / FWTM 16.0° / 30.0°
 Efficiency 58 %
 Peak intensity 5.3 cd/lm
 LEDs/each optic 1
 Light colour White
 Required components:
 F17435_HEKLA-G2-C

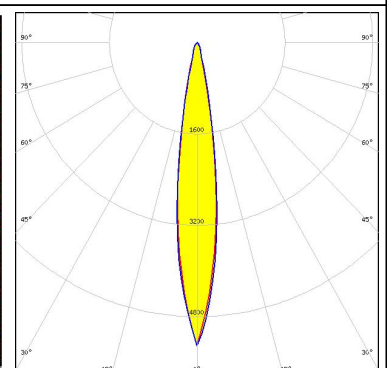
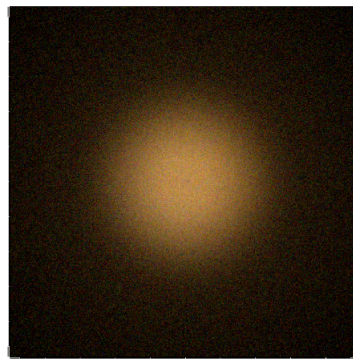

PHOTOMETRIC DATA (SIMULATED):

SAMSUNG

LED LC010C
FWHM / FWTM 12.0° / 22.0°
Efficiency 64 %
Peak intensity 11.2 cd/lm
LEDs/each optic 1
Light colour White
Required components:
F17435_HEKLA-G2-C

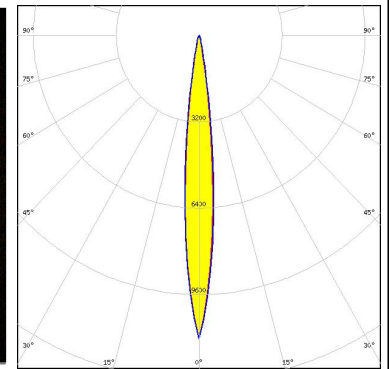

SAMSUNG

LED LH231B
FWHM / FWTM 15.0° / 28.0°
Efficiency 58 %
Peak intensity 6 cd/lm
LEDs/each optic 7
Light colour White
Required components:
F15255_HEKLA-SOCKET-C

GENERAL INFORMATION:

NOTE: The typical beam angle will be changed by different color, chip size and chip position tolerance. The typical total beam angle is the full angle measured where the luminous intensity is half of the peak value.

Due to use of high power COB's with this product, special attention to proper thermal design is highly recommended. LEDiL has no liability for direct, indirect or consecutive damages arising from the LEDiL products being used outside of the recommended temperature range.

MATERIALS:

As part of our continuous research and improvement processes, and to ensure the best possible quality and availability of our products, LEDiL reserves the right to change material grades without notice.

PRODUCT DATA USER AGREEMENT AND DISCLAIMER:

The measured data in the provided downloadable LEDiL Product Datasheets and Mechanical 2D-Drawings is rounded and provided as reference for planning. LEDiL Oy's optical specifications have been verified by conducting performance testing of the products in accordance with the company's quality system. The reported data are averaged results of multiple measurements with typical variation. LEDiL Oy reserves the right to without prior notification make changes and improvements to its products.

LEDiL Oy assumes neither warranty, nor guarantee nor any other liability of any kind for the contents and correctness of the provided data. The provided data has been generated with highest diligence but the provided data may in reality not represent the complete possible variation range of all intrinsic parameters. Therefore, in certain cases a deviation from the provided data could occur.

LEDiL Oy reserves the right to undertake technical changes of its products without further notification which could lead to changes in the provided data. LEDiL Oy assumes no liability of any kind for the possible deviation from any provided data or any other damage resulting from the usage of the provided data.

The user agrees to this disclaimer and user agreement with the download or usage of the provided files.

LEDiL Oy

Joensuunkatu 13
FI-24240 SALO
Finland

LEDiL Inc.

228 West Page Street
Suite D
Sycamore IL 60178
USA

Ledil Optics Technology (Shenzhen) Co., Ltd.

405 , Block B
Casic Motor Building
Shenzhen 518057
P.R.CHINA

Local sales and technical support

[www.ledil.com/
where_to_buy](http://www.ledil.com/where_to_buy)

Shipping locations

Salo, Finland
Hong Kong, China

Distribution Partners

[www.ledil.com/
where_to_buy](http://www.ledil.com/where_to_buy)

X-ON Electronics

Largest Supplier of Electrical and Electronic Components

Click to view similar products for [LED Lighting Lenses Assemblies](#) category:

Click to view products by [Ledil](#) manufacturer:

Other Similar products are found below :

[FCN12592_LE1-D-COP](#) [CA16129_OLGA-W](#) [CA16370_HB-SQ-W](#) [FN15972_RONDA-ZT45-C](#) [CS15759_HB-2X2MX-8-W](#)
[CA16435_LXP2-SS-WAS](#) [CN16210_GABRIELLA-MIDI-W](#) [CP17137_CARMEN-M2-C](#) [CA16015_STRADA-SQ-SCL](#) [CP17594_TINA-SC-](#)
[RS](#) [CS15767_HB-2X2MX-8-M](#) [CP10960_RGBX-SS](#) [CP12395_LXP3-W](#) [CP12939_LARISA-RS-CLIP16](#) [C14636_XTM-PF-ADAPTER](#)
[CA11819_STRADA-SQ-T-DW](#) [CA14508_G2-LXP2-D](#) [CA14601_VERONICA-SQ-MINI-RS](#) [FCP13895_SEANNA-A](#) [CP12943_LARISA-](#)
[O-CLIP16](#) [FP11124_LISA2-O-PIN](#) [CS14597_HB-IP-2X6-O](#) [CP14995_FLORENTINA-HLD-O](#) [CS15158_STRADA-IP-2X6-T4-B](#)
[CS16323_STRADELLA-IP-28-HB-M](#) [FN14976_STELLA-DWC2](#) [FN15264_STELLA-HB-WWW](#) [CA15584_ZORYA-MINI-TAPE](#)
[FA15229_ROSE-MRK-S](#) [FA15232_ROSE-MRK-M](#) [FA15233_ROSE-MRK-W](#) [FCN13552_CRYSTAL-RS](#) [FN15552_RONDA-W](#)
[FS15626_FLORENCE-3R-IP-Z90](#) [FS15786_FLORENCE-3R-IP-Z60](#) [FS15847_FLORENCE-3R-IP-O](#) [CA14505_G2-LXP2-RS2-P](#)
[FCN12775_IRIS-O](#) [CP15304_LARISA-RS-PIN](#) [FN15679_RONDA-S](#) [CA15519_VERONICA-SQ-MINI-D](#) [FP14414_LISA2-O-PIN](#)
[LL01CR-DF60L06-M2](#) [FN15993_RONDA-O](#) [FN15977_RONDA-WAS2](#) [CA14366_FLARE-MAXI-TAPE](#) [CA14442_VERONICA-SQ-W](#)
[CA14509_G2-LXP2-M-P](#) [CA15231_VERONICA-SQ-MINI-W](#) [FP11002_LISA2-W-PIN](#)