

YASMEEN-50-WW-C

~60° wide beam. Assembly with holder C compatible with HEKLA sockets and connectors. Black version.

TECHNICAL SPECIFICATIONS:

Dimensions	49.9 x 49.9 mm
Height	28.1 mm
ROHS compliant	yes ⓘ



MATERIAL SPECIFICATIONS:

Component	Type	Material	Colour	Finish
YASMEEN-50-WW	Single lens	PMMA	clear	
YASMEEN-50-HLD-C	Holder	PC	black	





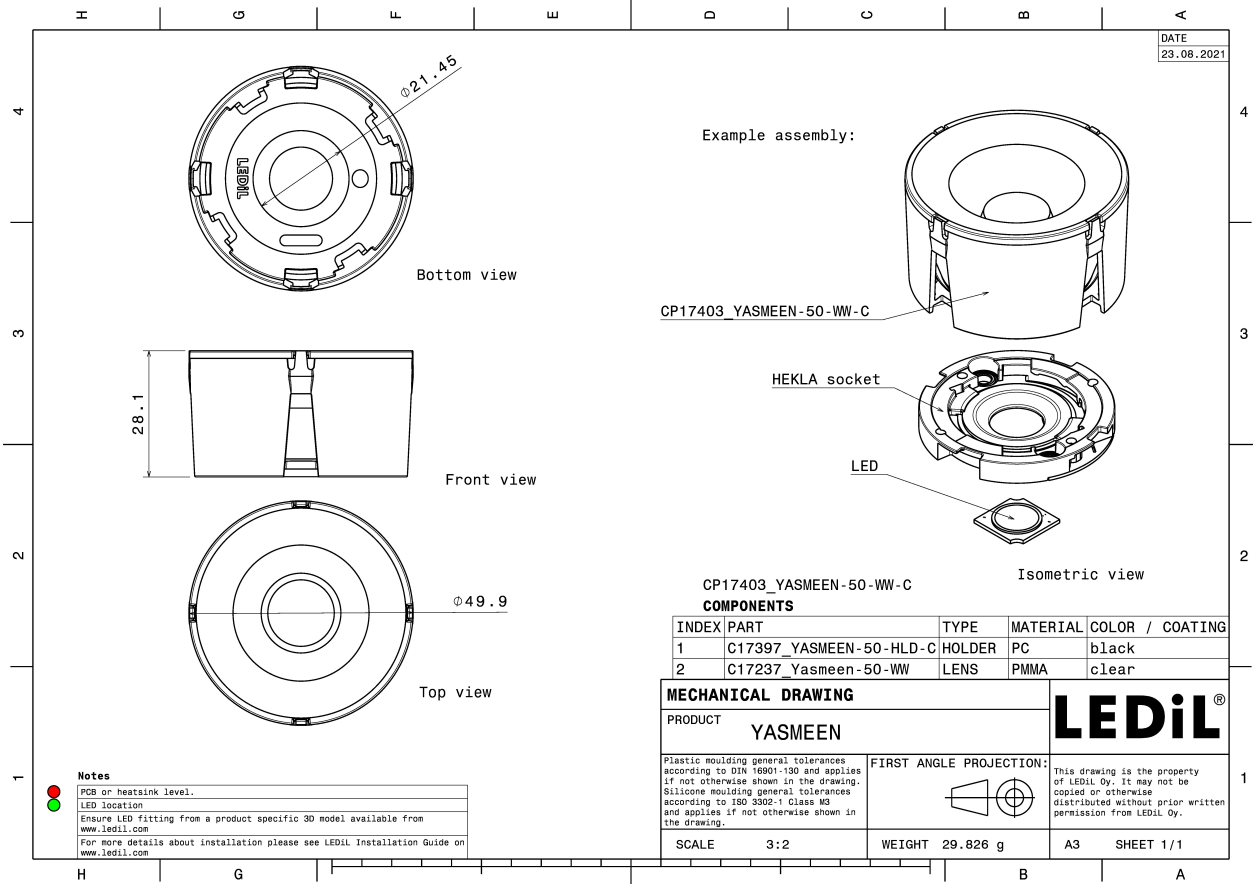

ORDERING INFORMATION:

Component		Qty in box	MOQ	MPQ	Box weight (kg)
CP17403_YASMEEN-50-WW-C	Single lens	252	112	28	9.8
» Box size: 476 x 273 x 305 mm					

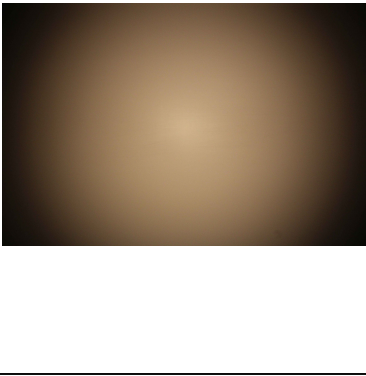
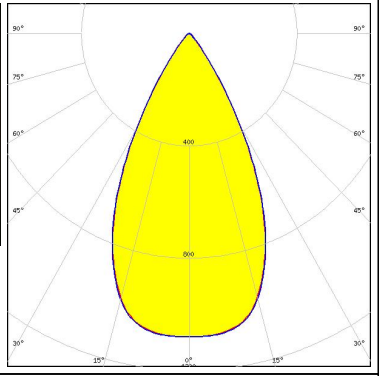

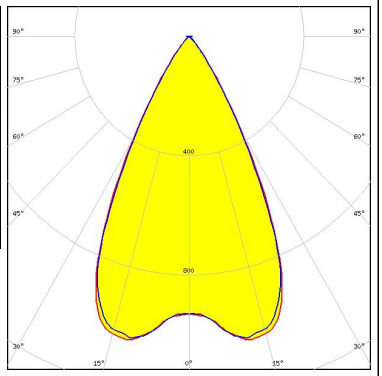

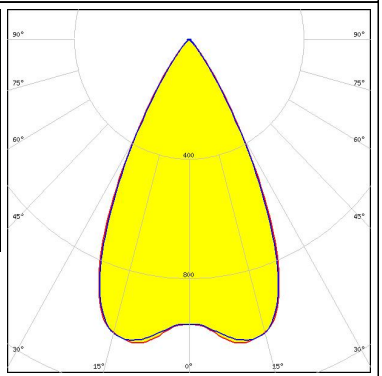

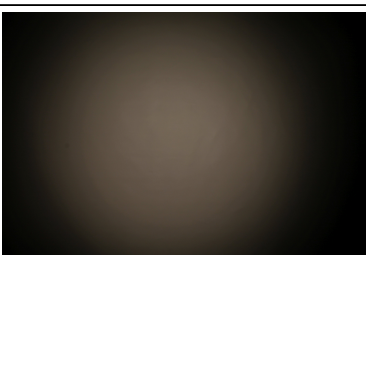
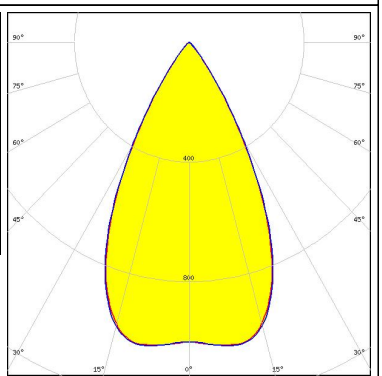

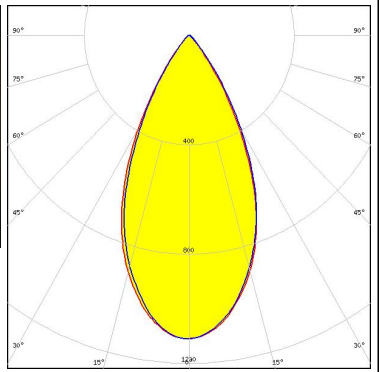

See also our general installation guide: www.ledil.com/installation_guide

PHOTOMETRIC DATA (MEASURED):

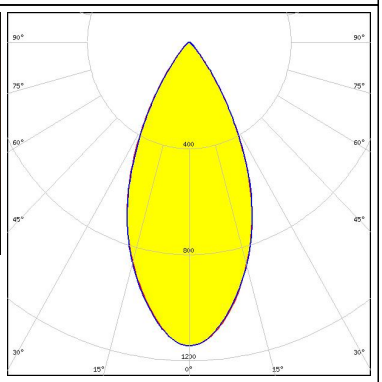
<p></p> <p>LED V11 HD FWHM / FWTM 54.0° / 76.0° Efficiency 83 % Peak intensity 1.1 cd/lm LEDs/each optic 1 Light colour White Required components: Bender Wirth: 633d Hekla</p>		
<p></p> <p>LED V4 HD FWHM / FWTM 54.0° / 74.0° Efficiency 83 % Peak intensity 1.1 cd/lm LEDs/each optic 1 Light colour White Required components: F15253_HEKLA-SOCKET-A</p>		
<p></p> <p>LED V6 HD FWHM / FWTM 55.0° / 75.0° Efficiency 83 % Peak intensity 1 cd/lm LEDs/each optic 1 Light colour White Required components: F15255_HEKLA-SOCKET-C</p>		
<p></p> <p>LED VERO10 FWHM / FWTM 54.0° / 76.0° Efficiency 82 % Peak intensity 1.1 cd/lm LEDs/each optic 1 Light colour White Required components: F15616_HEKLA-SOCKET-F</p>		

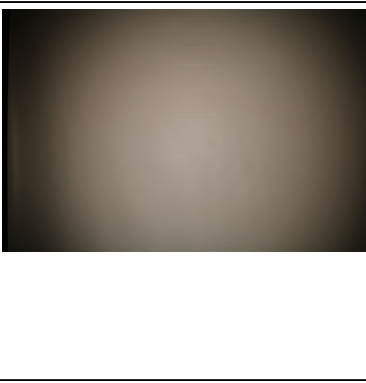
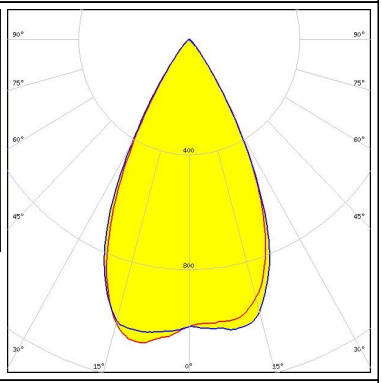
PHOTOMETRIC DATA (MEASURED):

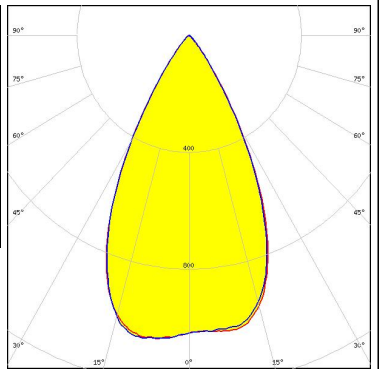
<p></p> <p>LED Vesta DTW 13mm (21W) FWHM / FWTM 51.0° / 78.0° Efficiency 79 % Peak intensity 1.1 cd/lm LEDs/each optic 1 Light colour Tunable White Required components: Bender Wirth: 632b Hekla XL</p>		
<p></p> <p>LED Vesta DTW 15mm (33W) FWHM / FWTM 49.0° / 78.0° Efficiency 79 % Peak intensity 1.1 cd/lm LEDs/each optic 1 Light colour Tunable White Required components: Bender Wirth: 632b Hekla XL</p>		
<p></p> <p>LED Vesta DTW 9mm (4W/6W/12W) FWHM / FWTM 55.0° / 76.0° Efficiency 83 % Peak intensity 1.1 cd/lm LEDs/each optic 1 Light colour White Required components: Bender Wirth: 652b Hekla</p>		
<p>CITIZEN</p> <p>LED CLL02x/CLU02x (LES10) FWHM / FWTM 54.0° / 76.0° Efficiency 83 % Peak intensity 1.1 cd/lm LEDs/each optic 1 Light colour White Required components: F17435_HEKLA-G2-C</p>		

PHOTOMETRIC DATA (MEASURED):

CITIZEN

LED CLU700/701/702
 FWHM / FWTM 55.0° / 75.0°
 Efficiency 84 %
 Peak intensity 1 cd/lm
 LEDs/each optic 1
 Light colour White
 Required components:
 F17435_HEKLA-G2-C

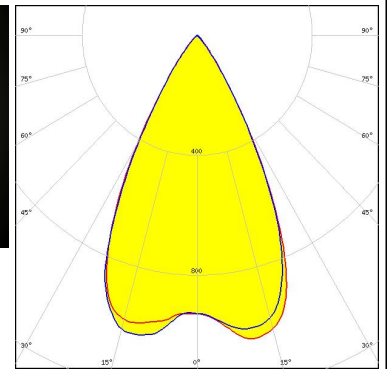
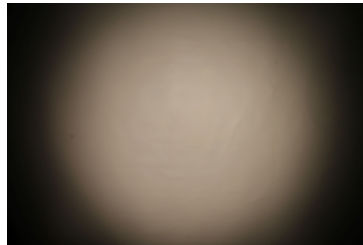

CITIZEN

LED CLU7A2 (LES 4.2mm)
 FWHM / FWTM 55.0° / 75.0°
 Efficiency 84 %
 Peak intensity 1.1 cd/lm
 LEDs/each optic 1
 Light colour White
 Required components:
 F17435_HEKLA-G2-C

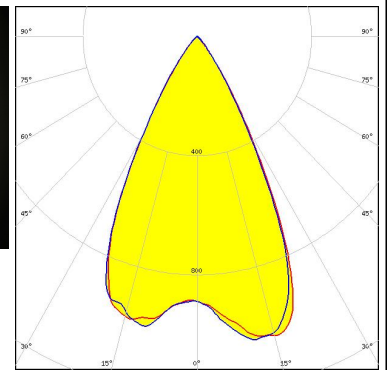
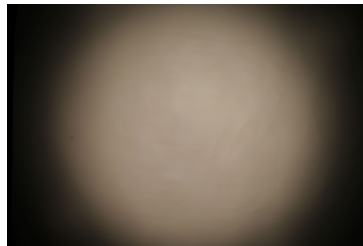

CITIZEN

LED CLU7B2
 FWHM / FWTM 54.0° / 74.0°
 Efficiency 84 %
 Peak intensity 1.1 cd/lm
 LEDs/each optic 1
 Light colour White
 Required components:
 F17435_HEKLA-G2-C

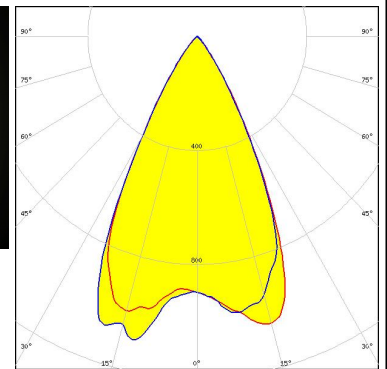
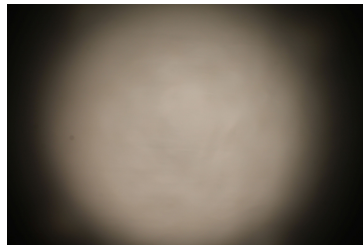





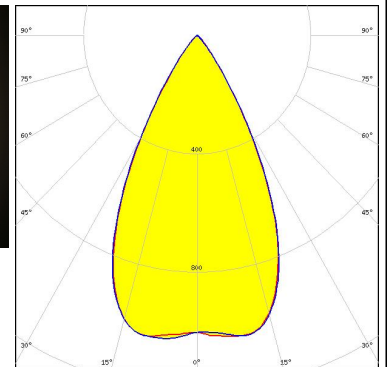
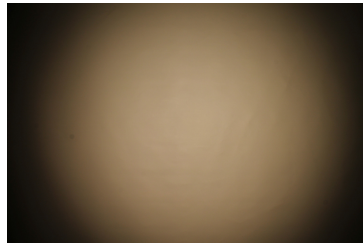

CREE LED

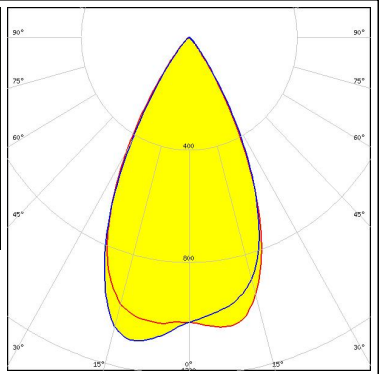

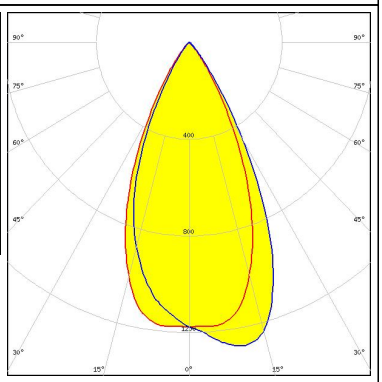

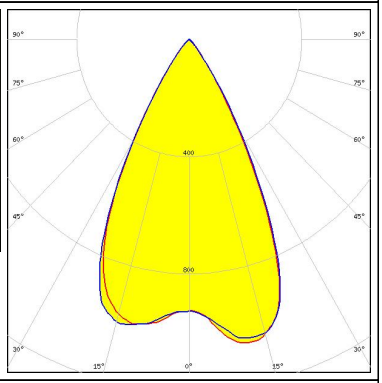
LED CMA1516
 FWHM / FWTM 54.0° / 76.0°
 Efficiency 83 %
 Peak intensity 1 cd/lm
 LEDs/each optic 1
 Light colour White
 Required components:
 F17436_HEKLA-G2-D

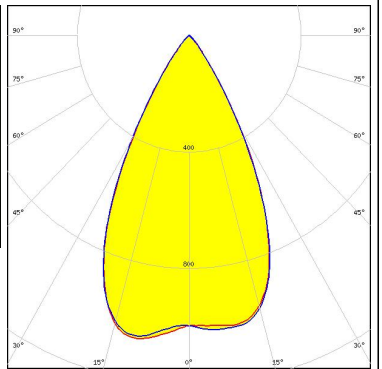



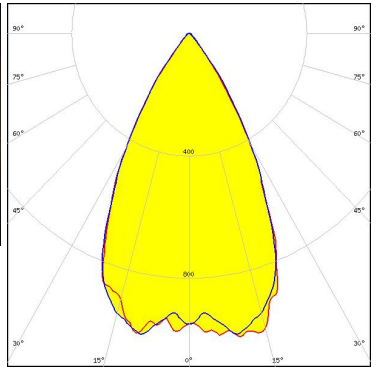

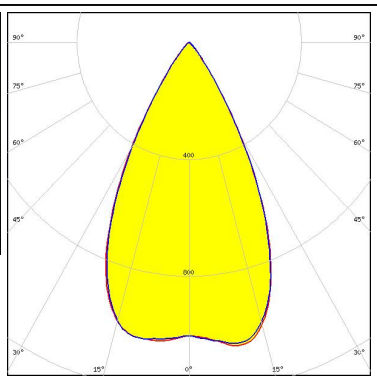

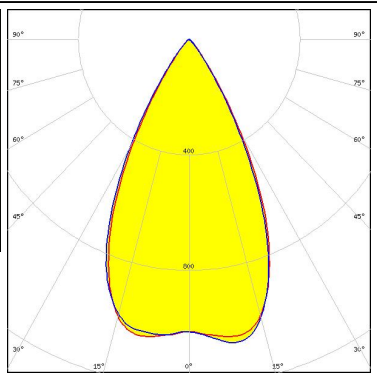
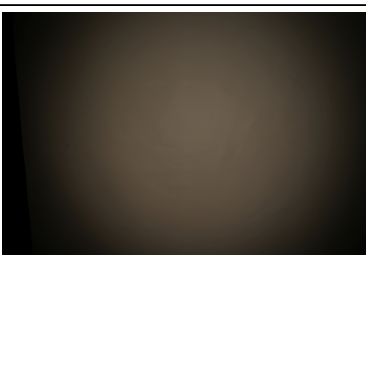
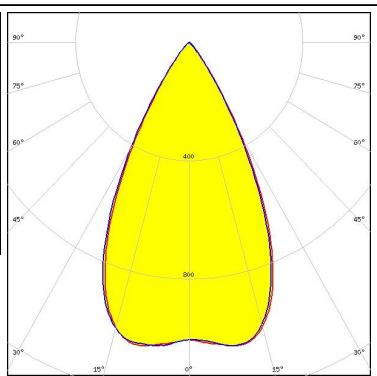
PHOTOMETRIC DATA (MEASURED):

<p>CREE → LED</p> <p>LED CMT14xx FWHM / FWTM 54.0° / 76.0° Efficiency 83 % Peak intensity 1.1 cd/lm LEDs/each optic 1 Light colour White Required components: F17435_HEKLA-G2-C</p>		
<p>CREE → LED</p> <p>LED CMU10xx FWHM / FWTM 48.0° / 72.0° Efficiency 81 % Peak intensity 1.3 cd/lm LEDs/each optic 1 Light colour White Required components: F17435_HEKLA-G2-C</p>		
<p>CREE → LED</p> <p>LED CXA/B 13xx FWHM / FWTM 55.0° / 74.0° Efficiency 84 % Peak intensity 1.1 cd/lm LEDs/each optic 1 Light colour White Required components: F17439_HEKLA-G2-J</p>		
<p>CREE → LED</p> <p>LED CXA/B 15xx FWHM / FWTM 54.0° / 75.0° Efficiency 84 % Peak intensity 1.1 cd/lm LEDs/each optic 1 Light colour White Required components: F17436_HEKLA-G2-D</p>		

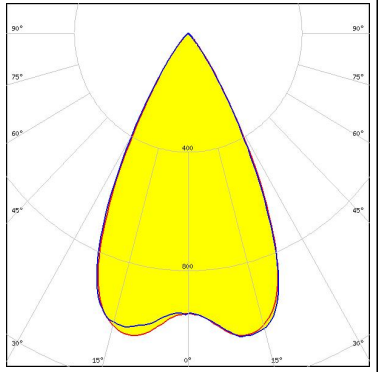
PHOTOMETRIC DATA (MEASURED):

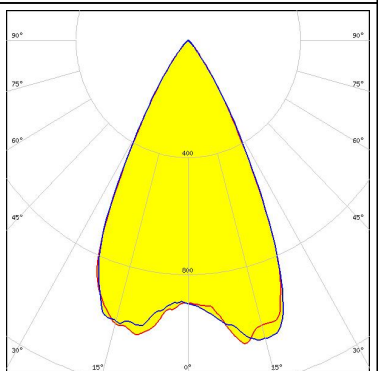
<p>LEDiM</p> <p>LED LEDIM/C6 FWHM / FWTM 57.0° / 78.0° Efficiency 83 % Peak intensity 1 cd/lm LEDs/each optic 9 Light colour White Required components: F17438_HEKLA-G2-I</p>		
<p>LUMILEDS</p> <p>LED LUXEON CoB 1202/1203 FWHM / FWTM 54.0° / 75.0° Efficiency 83 % Peak intensity 1.1 cd/lm LEDs/each optic 1 Light colour White Required components: F17437_HEKLA-G2-H</p>		
<p>LUMILEDS</p> <p>LED LUXEON CoB 1204HD FWHM / FWTM 53.0° / 75.0° Efficiency 83 % Peak intensity 1.1 cd/lm LEDs/each optic 1 Light colour White Required components: F17437_HEKLA-G2-H</p>		
<p>LUMILEDS</p> <p>LED LUXEON CoB M02/M03 FWHM / FWTM 54.0° / 75.0° Efficiency 84 % Peak intensity 1.1 cd/lm LEDs/each optic 1 Light colour White Required components: F17436_HEKLA-G2-D</p>		

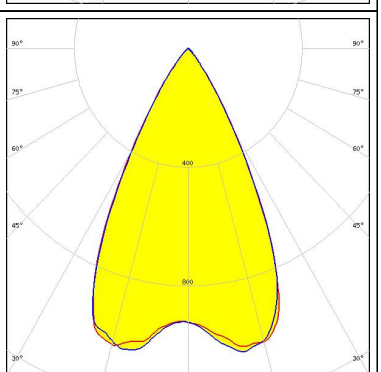
PHOTOMETRIC DATA (MEASURED):

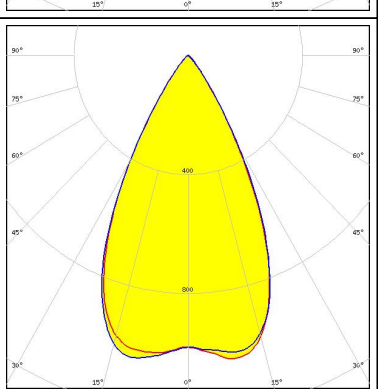
<p>LUMILEDS</p> <p>LED LUXEON CoB S01</p> <p>FWHM / FWTM 55.0° / 75.0°</p> <p>Efficiency 84 %</p> <p>Peak intensity 1.1 cd/lm</p> <p>LEDs/each optic 1</p> <p>Light colour White</p> <p>Required components: F17439_HEKLA-G2-J</p>		
<p>LUMINUS</p> <p>LED CXM-3</p> <p>FWHM / FWTM 55.0° / 75.0°</p> <p>Efficiency 84 %</p> <p>Peak intensity 1.1 cd/lm</p> <p>LEDs/each optic 1</p> <p>Light colour White</p> <p>Required components: F17435_HEKLA-G2-C</p>		
<p>LUMINUS</p> <p>LED CXM-4</p> <p>FWHM / FWTM 55.0° / 75.0°</p> <p>Efficiency 84 %</p> <p>Peak intensity 1.1 cd/lm</p> <p>LEDs/each optic 1</p> <p>Light colour White</p> <p>Required components: F17435_HEKLA-G2-C</p>		
<p>NICHIA</p> <p>LED COB L-Type (LES 9)</p> <p>FWHM / FWTM 54.0° / 76.0°</p> <p>Efficiency 83 %</p> <p>Peak intensity 1 cd/lm</p> <p>LEDs/each optic 1</p> <p>Light colour White</p> <p>Required components: F17437_HEKLA-G2-H</p>		

PHOTOMETRIC DATA (MEASURED):



LED COB S-Type (LES 7)
 FWHM / FWTM 55.0° / 75.0°
 Efficiency 82 %
 Peak intensity 1 cd/lm
 LEDs/each optic 1
 Light colour White
 Required components:
 F15848_HEKLA-SOCKET-G

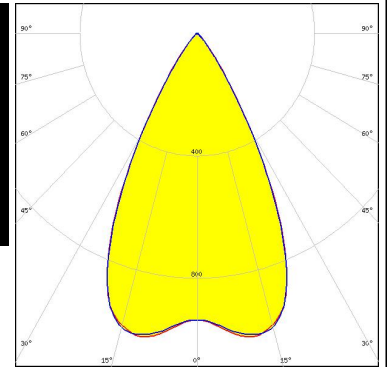

LED Fortimo SLM L09 CoB
 FWHM / FWTM 54.0° / 75.0°
 Efficiency 83 %
 Peak intensity 1.1 cd/lm
 LEDs/each optic 1
 Light colour White
 Required components:
 F17437_HEKLA-G2-H

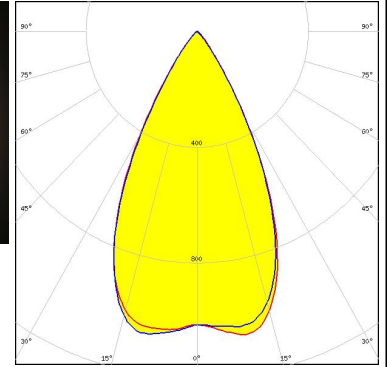



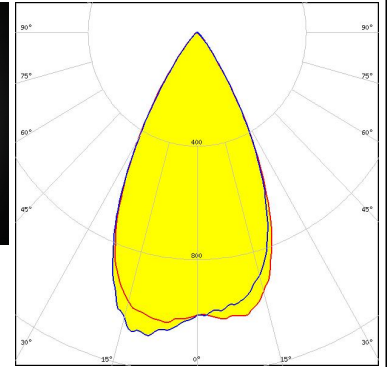

LED LC003D / LC006D / LC009D / LC013D
 FWHM / FWTM 54.0° / 76.0°
 Efficiency 83 %
 Peak intensity 1.1 cd/lm
 LEDs/each optic 1
 Light colour White
 Required components:
 F17435_HEKLA-G2-C

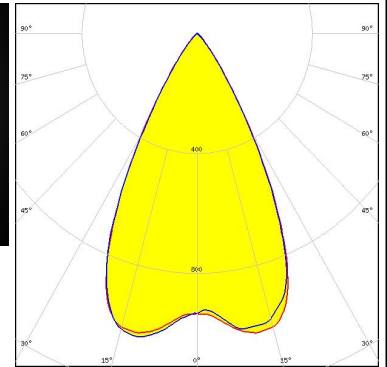
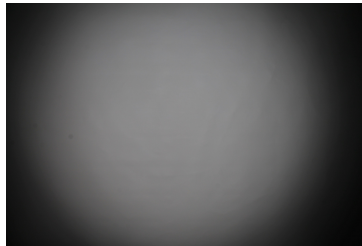

SEOL SEMICONDUCTOR
 LED MJT COB LES 6
 FWHM / FWTM 55.0° / 75.0°
 Efficiency 84 %
 Peak intensity 1.1 cd/lm
 LEDs/each optic 1
 Light colour White
 Required components:
 F17435_HEKLA-G2-C

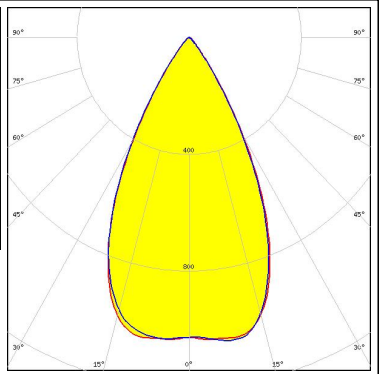

PHOTOMETRIC DATA (MEASURED):

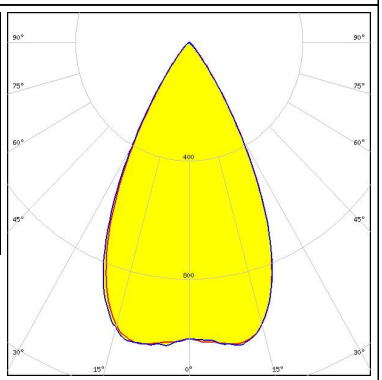
<p> SEUL SEMICONDUCTOR</p> <p>LED MJT COB LES 9.8</p> <p>FWHM / FWTM 54.0° / 76.0°</p> <p>Efficiency 83 %</p> <p>Peak intensity 1 cd/lm</p> <p>LEDs/each optic 1</p> <p>Light colour White</p> <p>Required components: F17435_HEKLA-G2-C</p>		
<p>TRIDONIC</p> <p>LED SLE G7 LES09</p> <p>FWHM / FWTM 54.0° / 76.0°</p> <p>Efficiency 84 %</p> <p>Peak intensity 1 cd/lm</p> <p>LEDs/each optic 1</p> <p>Light colour White</p> <p>Required components: F17435_HEKLA-G2-C</p>		

PHOTOMETRIC DATA (SIMULATED):



LED Vero SE 13
FWHM / FWTM 44.0° / 69.0°
Efficiency 77 %
Peak intensity 1.4 cd/lm
LEDs/each optic 1
Light colour White
Required components:
 C16142_HEKLA-SOCKET-K

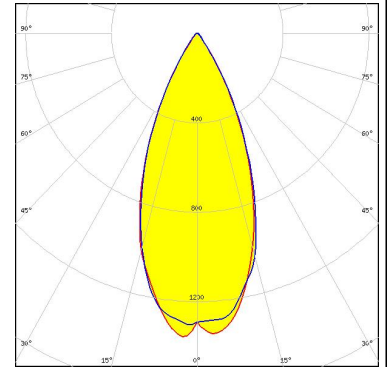

LED NVCWJ024Z-V1MT: COB J-Type Tunable White
FWHM / FWTM 63.0° / 84.0°
Efficiency 81 %
Peak intensity 0.8 cd/lm
LEDs/each optic 1
Light colour White
Required components:
 C16142_HEKLA-SOCKET-K
 Bender Wirth: 498 Typ L8 HV

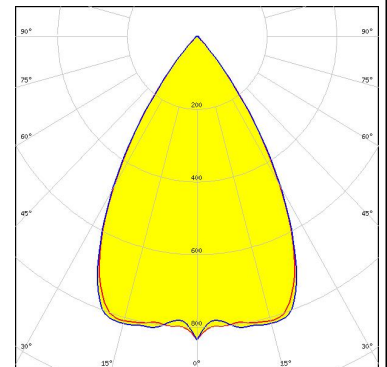

LED SLE G7 LES13
FWHM / FWTM 56.0° / 80.0°
Efficiency 81 %
Peak intensity 1 cd/lm
LEDs/each optic 1
Light colour White
Required components:
 F17438_HEKLA-G2-I

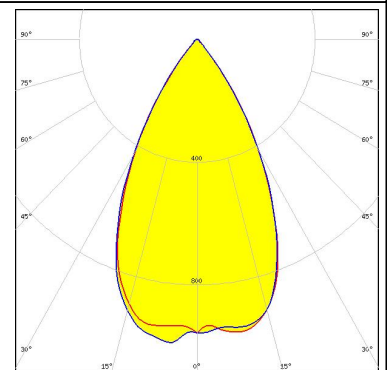

GENERAL INFORMATION:

NOTE: The typical beam angle will be changed by different color, chip size and chip position tolerance. The typical total beam angle is the full angle measured where the luminous intensity is half of the peak value.

Due to use of high power COB's with this product, special attention to proper thermal design is highly recommended. LEDiL has no liability for direct, indirect or consecutive damages arising from the LEDiL products being used outside of the recommended temperature range.

MATERIALS:

As part of our continuous research and improvement processes, and to ensure the best possible quality and availability of our products, LEDiL reserves the right to change material grades without notice.

PRODUCT DATA USER AGREEMENT AND DISCLAIMER:

The measured data in the provided downloadable LEDiL Product Datasheets and Mechanical 2D-Drawings is rounded and provided as reference for planning. LEDiL Oy's optical specifications have been verified by conducting performance testing of the products in accordance with the company's quality system. The reported data are averaged results of multiple measurements with typical variation. LEDiL Oy reserves the right to without prior notification make changes and improvements to its products.

LEDiL Oy assumes neither warranty, nor guarantee nor any other liability of any kind for the contents and correctness of the provided data. The provided data has been generated with highest diligence but the provided data may in reality not represent the complete possible variation range of all intrinsic parameters. Therefore, in certain cases a deviation from the provided data could occur.

LEDiL Oy reserves the right to undertake technical changes of its products without further notification which could lead to changes in the provided data. LEDiL Oy assumes no liability of any kind for the possible deviation from any provided data or any other damage resulting from the usage of the provided data.

The user agrees to this disclaimer and user agreement with the download or usage of the provided files.

LEDiL Oy

Joensuunkatu 13
FI-24240 SALO
Finland

LEDiL Inc.

228 West Page Street
Suite D
Sycamore IL 60178
USA

Ledil Optics Technology (Shenzhen) Co., Ltd.

405 , Block B
Casic Motor Building
Shenzhen 518057
P.R.CHINA

Local sales and technical support

[www.ledil.com/
where_to_buy](http://www.ledil.com/where_to_buy)

Shipping locations

Salo, Finland
Hong Kong, China

Distribution Partners

[www.ledil.com/
where_to_buy](http://www.ledil.com/where_to_buy)

X-ON Electronics

Largest Supplier of Electrical and Electronic Components

Click to view similar products for [LED Lighting Lenses Assemblies](#) category:

Click to view products by [Ledil](#) manufacturer:

Other Similar products are found below :

[CA11362_IRIS](#) [CA16127_OLGA-S](#) [CP16107_CARMEN-50-S-C](#) [CA16129_OLGA-W](#) [CA16370_HB-SQ-W](#) [FN15972_RONDA-ZT45-C](#)
[CS15759_HB-2X2MX-8-W](#) [CA16435_LXP2-SS-WAS](#) [CS13756_STRADA-IP-2X6-DWC-PC](#) [CN16210_GABRIELLA-MIDI-W](#)
[CP17137_CARMEN-M2-C](#) [CA16015_STRADA-SQ-SCL](#) [CP17594_TINA-SC-RS](#) [CS15767_HB-2X2MX-8-M](#) [CP18164_AMY-35-ZOOM-B](#)
[CP10960_RGBX-SS](#) [CP12395_LXP3-W](#) [CP12939_LARISA-RS-CLIP16](#) [C14636_XTM-PF-ADAPTER](#) [CA11819_STRADA-SQ-T-DW](#)
[CA14506_G2-LXP2-RS2](#) [CA14508_G2-LXP2-D](#) [CA14601_VERONICA-SQ-MINI-RS](#) [FCP13895_SEANNA-A](#) [FP11124_LISA2-O-PIN](#)
[CS14597_HB-IP-2X6-O](#) [CP14995_FLORENTINA-HLD-O](#) [CS15158_STRADA-IP-2X6-T4-B](#) [CS16323_STRADELLA-IP-28-HB-M](#)
[FN14976_STELLA-DWC2](#) [FN15264_STELLA-HB-WWW](#) [CA15584_ZORYA-MINI-TAPE](#) [FA15229_ROSE-MRK-S](#) [FA15232_ROSE-](#)
[MRK-M](#) [FCN13552_CRYSTAL-RS](#) [FN15552_RONDA-W](#) [FS15626_FLORENCE-3R-IP-Z90](#) [FS15786_FLORENCE-3R-IP-Z60](#)
[FS15847_FLORENCE-3R-IP-O](#) [CA14505_G2-LXP2-RS2-P](#) [CP12944_LARISA-W-CLIP8](#) [FCN12775_IRIS-O](#) [FCA15007_G2-ROSE-UV-SS](#)
[CP15304_LARISA-RS-PIN](#) [FN15679_RONDA-S](#) [CA15519_VERONICA-SQ-MINI-D](#) [FP14414_LISA2-O-PIN](#) [LL01CR-DF60L06-M2](#)
[FN15993_RONDA-O](#) [FN15977_RONDA-WAS2](#)