

## YASMEEN-70-M-C

~26° wide beam. Assembly with holder C compatible with HEKLA sockets and connectors. Black version.

### TECHNICAL SPECIFICATIONS:

Dimensions	Ø 69.9 mm
Height	39.9 mm
ROHS compliant	yes ⓘ



### MATERIAL SPECIFICATIONS:

Component	Type	Material	Colour	Finish
YASMEEN-70-M	Single lens	PMMA	clear	
YASMEEN-70-HLD-C	Holder	PC	black	





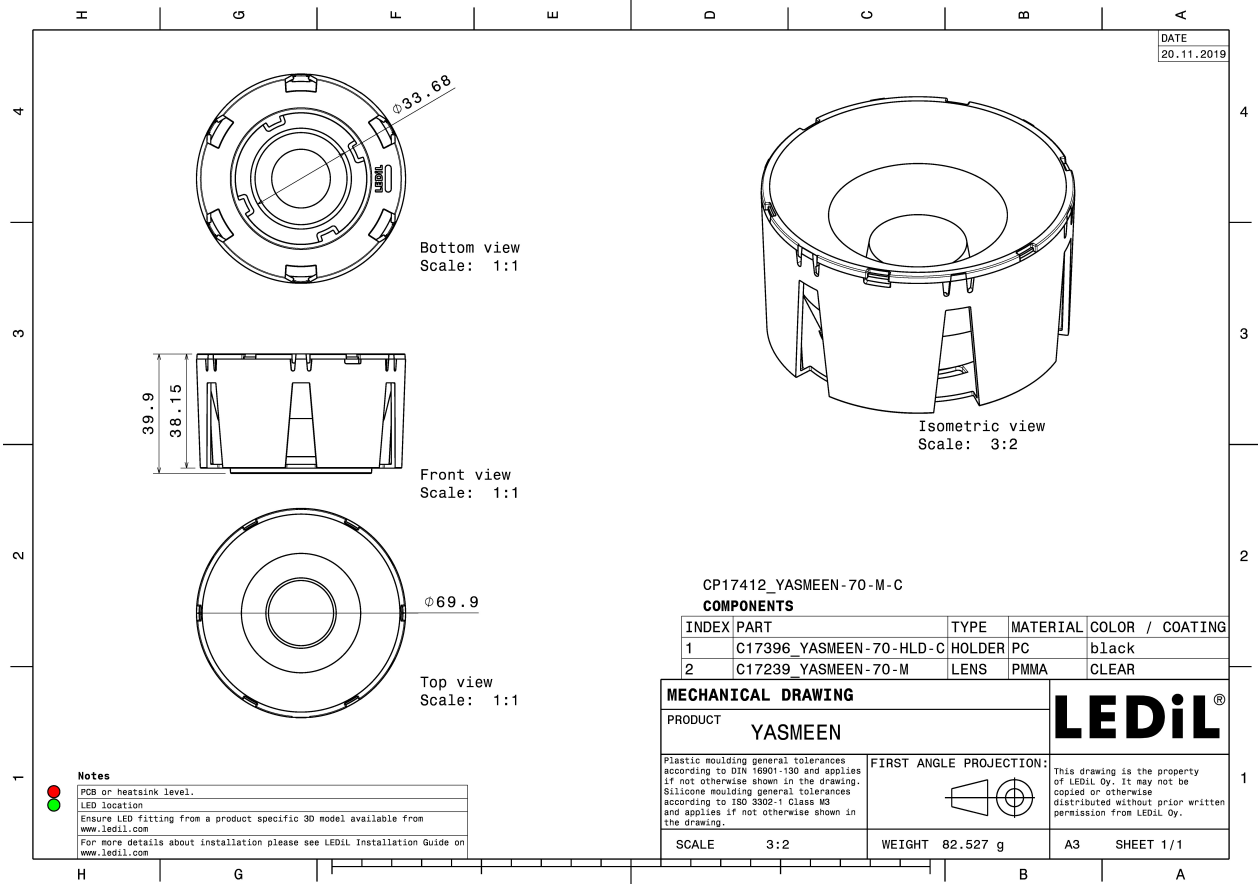



### ORDERING INFORMATION:

Component	Type	Qty in box	MOQ	MPQ	Box weight (kg)
CP17412_YASMEEN-70-M-C	Single lens	105	105	15	10.0
» Box size: 476 x 273 x 305 mm					

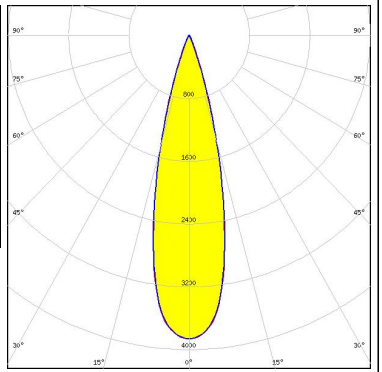

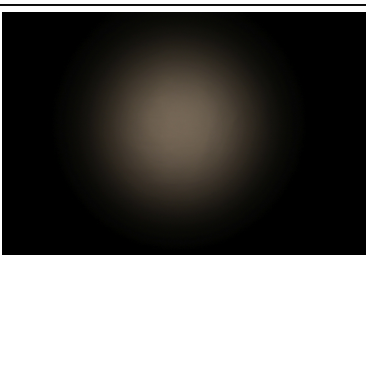
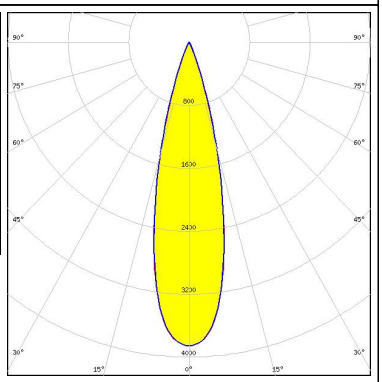

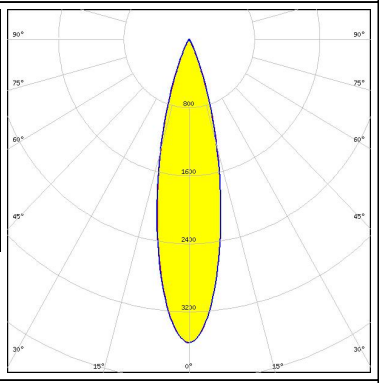

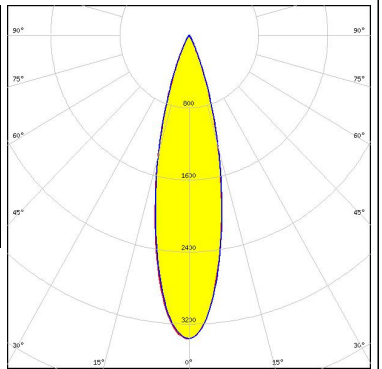



See also our general installation guide: [www.ledil.com/installation\\_guide](http://www.ledil.com/installation_guide)

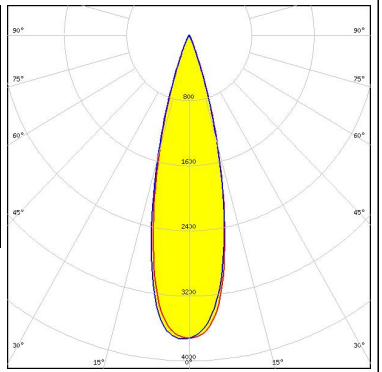

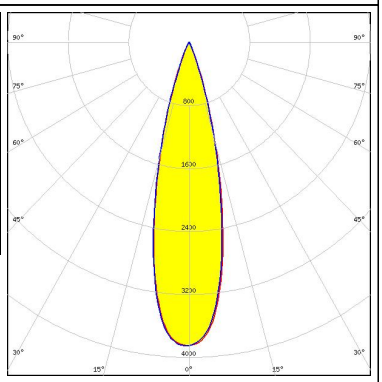

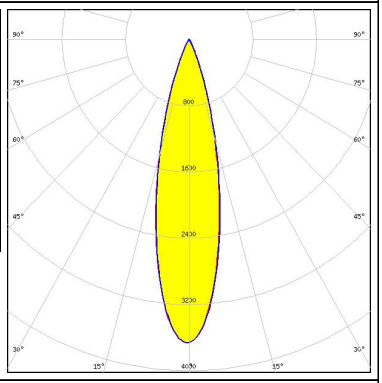

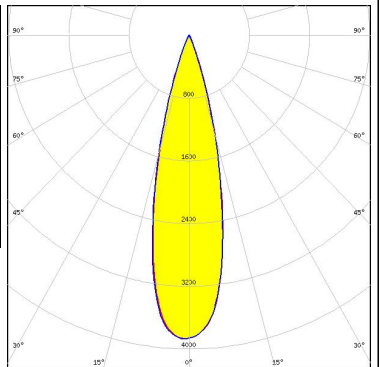
#### PHOTOMETRIC DATA (MEASURED):

<p></p> <p>LED V9 HD</p> <p>FWHM / FWTM 26.0° / 42.0°</p> <p>Efficiency 83 %</p> <p>Peak intensity 3.9 cd/m</p> <p>LEDs/each optic 1</p> <p>Light colour White</p> <p>Required components: F15859_HEKLA-SOCKET-I</p>		
<p></p> <p>LED VERO10</p> <p>FWHM / FWTM 26.0° / 42.5°</p> <p>Efficiency 84 %</p> <p>Peak intensity 3.9 cd/m</p> <p>LEDs/each optic 1</p> <p>Light colour White</p> <p>Required components: F15616_HEKLA-SOCKET-F</p>		
<p></p> <p>LED Vesta DTW 13mm (21W)</p> <p>FWHM / FWTM 25.0° / 46.0°</p> <p>Efficiency 81 %</p> <p>Peak intensity 3.6 cd/m</p> <p>LEDs/each optic 1</p> <p>Light colour Tunable White</p> <p>Required components: Bender Wirth: 632b Hekla XL</p>		
<p></p> <p>LED Vesta DTW 15mm (33W)</p> <p>FWHM / FWTM 26.0° / 48.0°</p> <p>Efficiency 81 %</p> <p>Peak intensity 3.4 cd/m</p> <p>LEDs/each optic 1</p> <p>Light colour Tunable White</p> <p>Required components: Bender Wirth: 632b Hekla XL</p>		

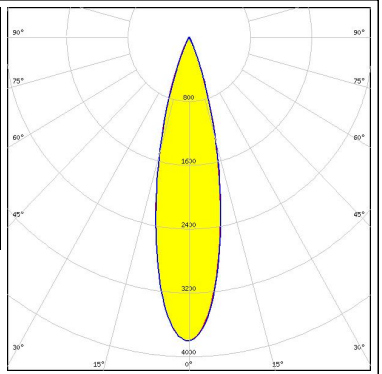
#### PHOTOMETRIC DATA (MEASURED):

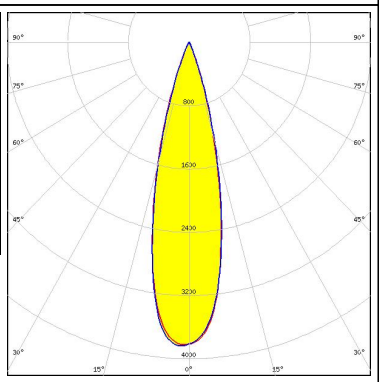
<p></p> <p>LED Vesta DTW 9mm (4W/6W/12W)            FWHM / FWTM 27.0° / 43.0°            Efficiency 83 %            Peak intensity 3.7 cd/lm            LEDs/each optic 1            Light colour White            Required components:            Bender Wirth: 652b Hekla</p>		
<p><b>CITIZEN</b></p> <p>LED CLL02x/CLU02x (LES10)            FWHM / FWTM 25.0° / 42.0°            Efficiency 83 %            Peak intensity 3.9 cd/lm            LEDs/each optic 1            Light colour White            Required components:            F17435_HEKLA-G2-C</p>		
<p><b>CITIZEN</b></p> <p>LED CLL03x/CLU03x            FWHM / FWTM 25.0° / 45.0°            Efficiency 82 %            Peak intensity 3.7 cd/lm            LEDs/each optic 1            Light colour White            Required components:            F17438_HEKLA-G2-I</p>		
<p></p> <p>LED CMA1516            FWHM / FWTM 26.0° / 42.0°            Efficiency 83 %            Peak intensity 3.9 cd/lm            LEDs/each optic 1            Light colour White            Required components:            F17436_HEKLA-G2-D</p>		

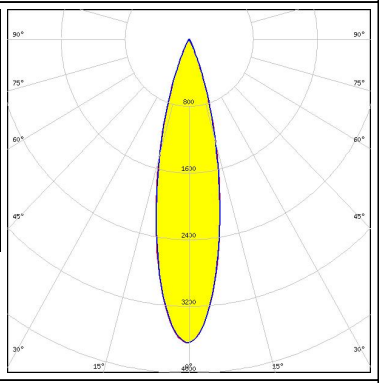
#### PHOTOMETRIC DATA (MEASURED):

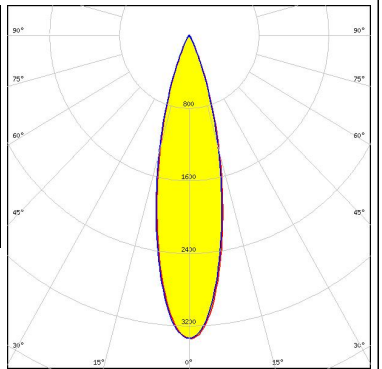
<p><b>CREE</b> → <b>LED</b></p> <p>LED CMA1825            FWHM / FWTM 25.0° / 44.0°            Efficiency 83 %            Peak intensity 3.8 cd/m            LEDs/each optic 1            Light colour White            Required components:            F15254_HEKLA-SOCKET-B</p>		
<p><b>CREE</b> → <b>LED</b></p> <p>LED CMT14xx            FWHM / FWTM 26.0° / 42.0°            Efficiency 83 %            Peak intensity 3.8 cd/m            LEDs/each optic 1            Light colour White            Required components:            F17435_HEKLA-G2-C</p>		
<p><b>CREE</b> → <b>LED</b></p> <p>LED CMT19xx            FWHM / FWTM 24.0° / 45.0°            Efficiency 81 %            Peak intensity 3.6 cd/m            LEDs/each optic 1            Light colour White            Required components:            F17438_HEKLA-G2-I</p>		
<p><b>CREE</b> → <b>LED</b></p> <p>LED CMU15xx            FWHM / FWTM 26.0° / 47.0°            Efficiency 79 %            Peak intensity 3.3 cd/m            LEDs/each optic 1            Light colour White            Required components:            F17438_HEKLA-G2-I</p>		

#### PHOTOMETRIC DATA (MEASURED):

#### LUMILEDS

LED LUXEON CoB 1202/1203  
 FWHM / FWTM 26.0° / 42.0°  
 Efficiency 82 %  
 Peak intensity 3.9 cd/m  
 LEDs/each optic 1  
 Light colour White  
 Required components:  
 F17437\_HEKLA-G2-H

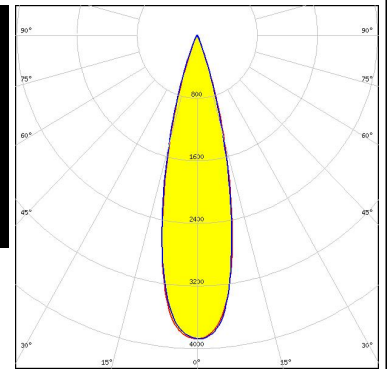

#### NICHIA

LED COB L-Type (LES 11)  
 FWHM / FWTM 24.0° / 43.0°  
 Efficiency 82 %  
 Peak intensity 3.9 cd/m  
 LEDs/each optic 1  
 Light colour White  
 Required components:  
 F17437\_HEKLA-G2-H

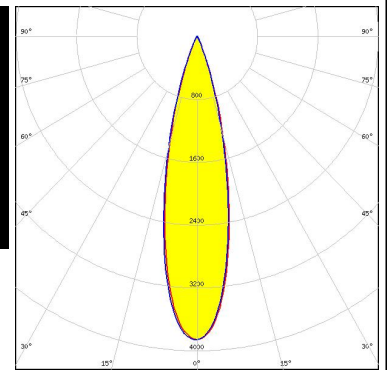

#### NICHIA

LED COB L-Type (LES 9)  
 FWHM / FWTM 26.0° / 42.0°  
 Efficiency 82 %  
 Peak intensity 3.8 cd/m  
 LEDs/each optic 1  
 Light colour White  
 Required components:  
 F17437\_HEKLA-G2-H

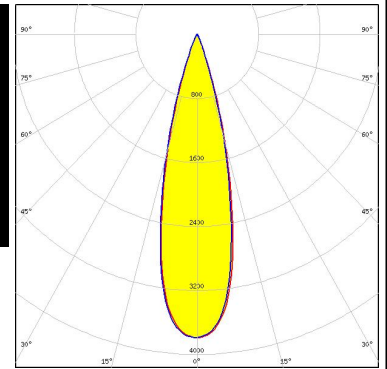

#### NICHIA

LED COB S-Type (LES 7)  
 FWHM / FWTM 24.0° / 45.0°  
 Efficiency 81 %  
 Peak intensity 3.8 cd/m  
 LEDs/each optic 1  
 Light colour White  
 Required components:  
 F17438\_HEKLA-G2-I

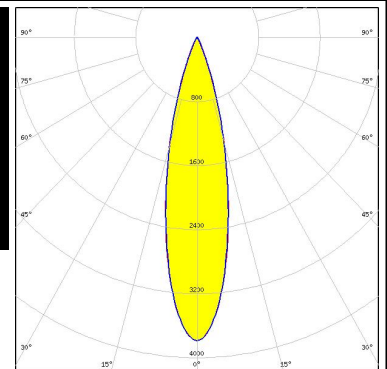
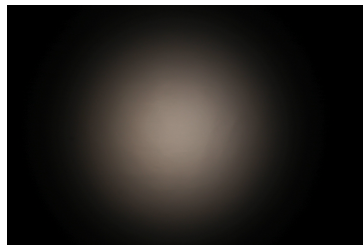

#### PHOTOMETRIC DATA (MEASURED):

### PHILIPS

LED Fortimo SLM L09 CoB  
 FWHM / FWTM 25.0° / 42.0°  
 Efficiency 82 %  
 Peak intensity 3.9 cd/m  
 LEDs/each optic 1  
 Light colour White  
 Required components:  
 F17437\_HEKLA-G2-H

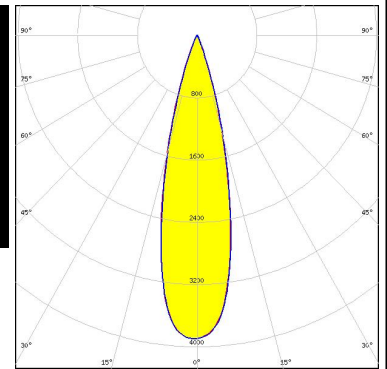

### SAMSUNG

LED LC016D / LC019D / LC026D / LC033D  
 FWHM / FWTM 26.0° / 47.0°  
 Efficiency 81 %  
 Peak intensity 3.4 cd/m  
 LEDs/each optic 1  
 Light colour White  
 Required components:  
 F17438\_HEKLA-G2-I

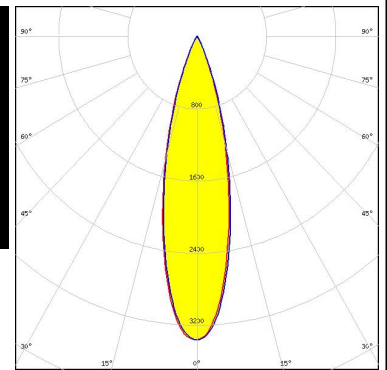

### SAMSUNG

LED LC030C/040C G2  
 FWHM / FWTM 25.0° / 45.0°  
 Efficiency 82 %  
 Peak intensity 3.9 cd/m  
 LEDs/each optic 1  
 Light colour White  
 Required components:  
 F17438\_HEKLA-G2-I

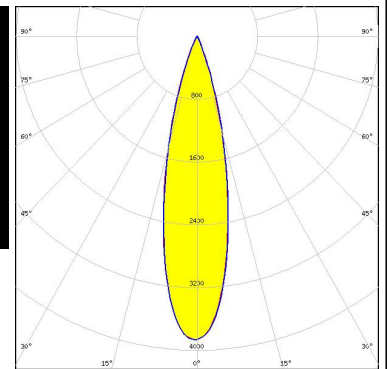
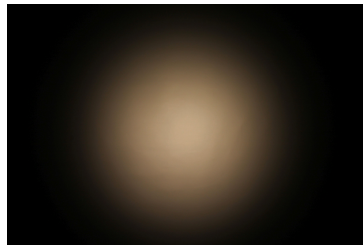

SEOUL SEMICONDUCTOR

LED MJT COB LES 14.5  
 FWHM / FWTM 25.0° / 46.0°  
 Efficiency 81 %  
 Peak intensity 3.5 cd/m  
 LEDs/each optic 1  
 Light colour White  
 Required components:  
 F17438\_HEKLA-G2-I

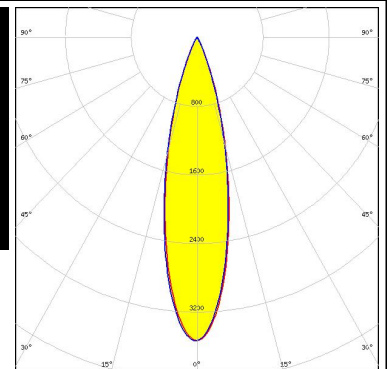

#### PHOTOMETRIC DATA (MEASURED):

#### TRIDONIC

LED SLE G7 LES09  
FWHM / FWTM 26.0° / 42.0°  
Efficiency 83 %  
Peak intensity 3.9 cd/lm  
LEDs/each optic 1  
Light colour White  
Required components:  
F17435\_HEKLA-G2-C

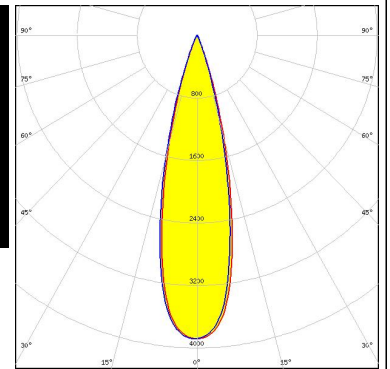





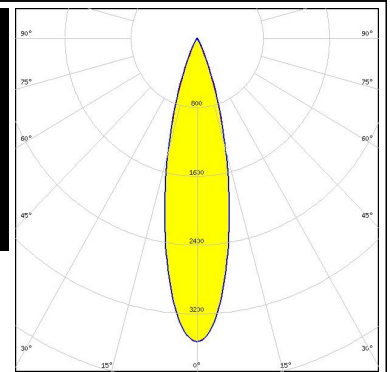
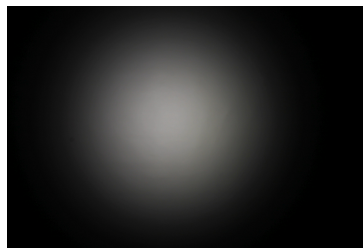

#### TRIDONIC

LED SLE G7 LES15  
FWHM / FWTM 25.0° / 46.0°  
Efficiency 81 %  
Peak intensity 3.5 cd/lm  
LEDs/each optic 1  
Light colour White  
Required components:  
F17438\_HEKLA-G2-I

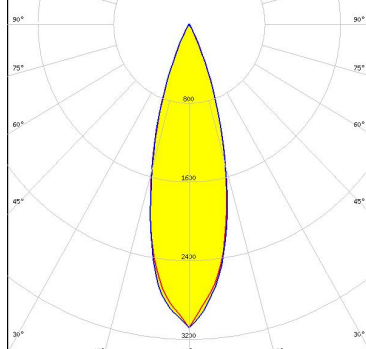

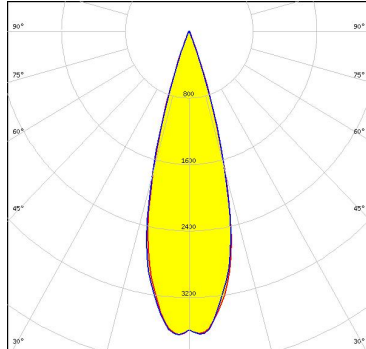

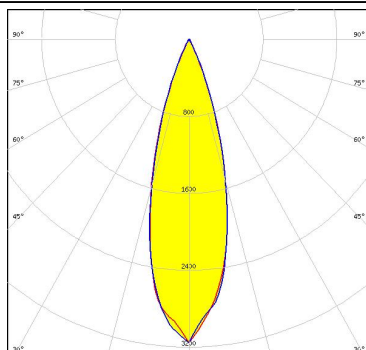
#### PHOTOMETRIC DATA (SIMULATED):

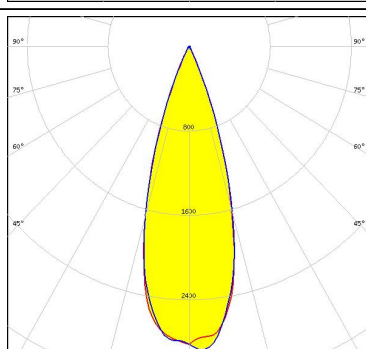
<p></p> <p>LED V13 Gen7</p> <p>FWHM / FWTM 30.0° / 50.0°</p> <p>Efficiency 86 %</p> <p>Peak intensity 3.1 cd/lm</p> <p>LEDs/each optic 1</p> <p>Light colour White</p> <p>Required components:</p>	
<p></p> <p>LED V6 HD</p> <p>FWHM / FWTM 30.0° / 42.0°</p> <p>Efficiency 86 %</p> <p>Peak intensity 3.7 cd/lm</p> <p>LEDs/each optic 1</p> <p>Light colour White</p> <p>Required components: F15255_HEKLA-SOCKET-C</p>	
<p></p> <p>LED Vesta TW 13mm (25W) CSP</p> <p>FWHM / FWTM 30.0° / 50.0°</p> <p>Efficiency 86 %</p> <p>Peak intensity 3.2 cd/lm</p> <p>LEDs/each optic 1</p> <p>Light colour White</p> <p>Required components: C16142_HEKLA-SOCKET-K</p>	
<p></p> <p>LED Vesta TW 9mm (12W) CSP</p> <p>FWHM / FWTM 32.0° / 50.0°</p> <p>Efficiency 87 %</p> <p>Peak intensity 2.9 cd/lm</p> <p>LEDs/each optic 1</p> <p>Light colour White</p> <p>Required components: C16142_HEKLA-SOCKET-K</p>	

#### PHOTOMETRIC DATA (SIMULATED):

#### CITIZEN

LED CLU712  
 FWHM / FWTM 28.0° / 42.0°  
 Efficiency 84 %  
 Peak intensity 3.8 cd/lm  
 LEDs/each optic 1  
 Light colour White  
 Required components:  
 F17438\_HEKLA-G2-I

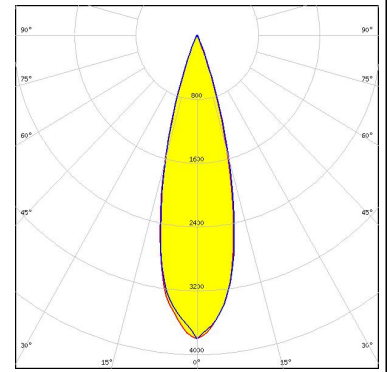

#### CREE LED

LED CMU10xx  
 FWHM / FWTM 27.0° / 44.0°  
 Efficiency 85 %  
 Peak intensity 3.9 cd/lm  
 LEDs/each optic 1  
 Light colour White  
 Required components:  
 F17435\_HEKLA-G2-C

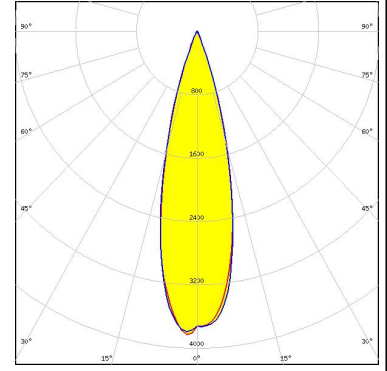

#### CREE LED

LED CXA/B 13xx  
 FWHM / FWTM 30.0° / 43.0°  
 Efficiency 85 %  
 Peak intensity 3.6 cd/lm  
 LEDs/each optic 1  
 Light colour White  
 Required components:  
 F17439\_HEKLA-G2-J

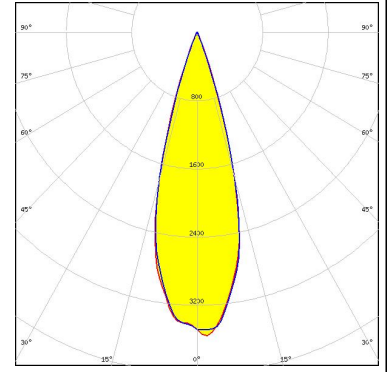

#### CREE LED

LED CXA/B 15xx  
 FWHM / FWTM 28.0° / 42.0°  
 Efficiency 84 %  
 Peak intensity 3.8 cd/lm  
 LEDs/each optic 1  
 Light colour White  
 Required components:  
 F17436\_HEKLA-G2-D

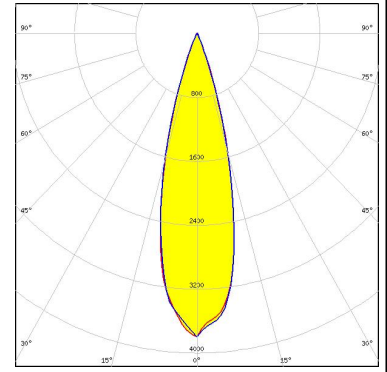

### PHOTOMETRIC DATA (SIMULATED):

<p><b>CREE</b> LED</p> <p>LED: CXA/B 1830            FWHM / FWTM: 26.0° / 46.0°            Efficiency: 83 %            Peak intensity: 3.6 cd/lm            LEDs/each optic: 1            Light colour: White            Required components:            Bender Wirth: 637b Hekla</p>	
<p><b>NICHIA</b></p> <p>LED: NVCWJ024Z-V1MT: COB J-Type Tunable White            FWHM / FWTM: 28.0° / 47.0°            Efficiency: 85 %            Peak intensity: 3.4 cd/lm            LEDs/each optic: 1            Light colour: White            Required components:            C16142_HEKLA-SOCKET-K            Bender Wirth: 498 Typ L8 HV</p>	
<p><b>SAMSUNG</b></p> <p>LED: LC003D / LC006D / LC009D / LC013D            FWHM / FWTM: 26.0° / 43.0°            Efficiency: 84 %            Peak intensity: 4 cd/lm            LEDs/each optic: 1            Light colour: White            Required components:            F17435_HEKLA-G2-C</p>	
<p><b>TRIDONIC</b></p> <p>LED: SLE G7 LES13            FWHM / FWTM: 26.0° / 46.0°            Efficiency: 83 %            Peak intensity: 3.8 cd/lm            LEDs/each optic: 1            Light colour: White            Required components:            F17438_HEKLA-G2-I</p>	

#### GENERAL INFORMATION:

NOTE: The typical beam angle will be changed by different color, chip size and chip position tolerance. The typical total beam angle is the full angle measured where the luminous intensity is half of the peak value.

Due to use of high power COB's with this product, special attention to proper thermal design is highly recommended. LEDiL has no liability for direct, indirect or consecutive damages arising from the LEDiL products being used outside of the recommended temperature range.

#### MATERIALS:

As part of our continuous research and improvement processes, and to ensure the best possible quality and availability of our products, LEDiL reserves the right to change material grades without notice.

#### PRODUCT DATA USER AGREEMENT AND DISCLAIMER:

The measured data in the provided downloadable LEDiL Product Datasheets and Mechanical 2D-Drawings is rounded and provided as reference for planning. LEDiL Oy's optical specifications have been verified by conducting performance testing of the products in accordance with the company's quality system. The reported data are averaged results of multiple measurements with typical variation. LEDiL Oy reserves the right to without prior notification make changes and improvements to its products.

LEDiL Oy assumes neither warranty, nor guarantee nor any other liability of any kind for the contents and correctness of the provided data. The provided data has been generated with highest diligence but the provided data may in reality not represent the complete possible variation range of all intrinsic parameters. Therefore, in certain cases a deviation from the provided data could occur.

LEDiL Oy reserves the right to undertake technical changes of its products without further notification which could lead to changes in the provided data. LEDiL Oy assumes no liability of any kind for the possible deviation from any provided data or any other damage resulting from the usage of the provided data.

The user agrees to this disclaimer and user agreement with the download or usage of the provided files.

#### LEDiL Oy

Joensuunkatu 13  
FI-24240 SALO  
Finland

#### LEDiL Inc.

228 West Page Street  
Suite D  
Sycamore IL 60178  
USA

#### Ledil Optics Technology (Shenzhen) Co., Ltd.

# 405 , Block B  
Casic Motor Building  
Shenzhen 518057  
P.R.CHINA

#### Local sales and technical support

[www.ledil.com/  
where\\_to\\_buy](http://www.ledil.com/where_to_buy)

#### Shipping locations

Salo, Finland  
Hong Kong, China

#### Distribution Partners

[www.ledil.com/  
where\\_to\\_buy](http://www.ledil.com/where_to_buy)

## X-ON Electronics

Largest Supplier of Electrical and Electronic Components

*Click to view similar products for [LED Lighting Lenses Assemblies](#) category:*

*Click to view products by [Ledil](#) manufacturer:*

Other Similar products are found below :

[CA11362\\_IRIS](#) [CA16127\\_OLGA-S](#) [CP16107\\_CARMEN-50-S-C](#) [CA16129\\_OLGA-W](#) [CA16370\\_HB-SQ-W](#) [FN15972\\_RONDA-ZT45-C](#)  
[CS15759\\_HB-2X2MX-8-W](#) [CA16435\\_LXP2-SS-WAS](#) [CS13756\\_STRADA-IP-2X6-DWC-PC](#) [CN16210\\_GABRIELLA-MIDI-W](#)  
[CP17137\\_CARMEN-M2-C](#) [CA16015\\_STRADA-SQ-SCL](#) [CP17594\\_TINA-SC-RS](#) [CS15767\\_HB-2X2MX-8-M](#) [CP18164\\_AMY-35-ZOOM-B](#)  
[CP10960\\_RGBX-SS](#) [CP12395\\_LXP3-W](#) [CP12939\\_LARISA-RS-CLIP16](#) [C14636\\_XTM-PF-ADAPTER](#) [CA11819\\_STRADA-SQ-T-DW](#)  
[CA14506\\_G2-LXP2-RS2](#) [CA14508\\_G2-LXP2-D](#) [CA14601\\_VERONICA-SQ-MINI-RS](#) [FCP13895\\_SEANNA-A](#) [FP11124\\_LISA2-O-PIN](#)  
[CS14597\\_HB-IP-2X6-O](#) [CP14995\\_FLORENTINA-HLD-O](#) [CS15158\\_STRADA-IP-2X6-T4-B](#) [CS16323\\_STRADELLA-IP-28-HB-M](#)  
[FN14976\\_STELLA-DWC2](#) [FN15264\\_STELLA-HB-WWW](#) [CA15584\\_ZORYA-MINI-TAPE](#) [FA15229\\_ROSE-MRK-S](#) [FA15232\\_ROSE-](#)  
[MRK-M](#) [FCN13552\\_CRYSTAL-RS](#) [FN15552\\_RONDA-W](#) [FS15626\\_FLORENCE-3R-IP-Z90](#) [FS15786\\_FLORENCE-3R-IP-Z60](#)  
[FS15847\\_FLORENCE-3R-IP-O](#) [CA14505\\_G2-LXP2-RS2-P](#) [CP12944\\_LARISA-W-CLIP8](#) [FCN12775\\_IRIS-O](#) [FCA15007\\_G2-ROSE-UV-SS](#)  
[CP15304\\_LARISA-RS-PIN](#) [FN15679\\_RONDA-S](#) [CA15519\\_VERONICA-SQ-MINI-D](#) [FP14414\\_LISA2-O-PIN](#) [LL01CR-DF60L06-M2](#)  
[FN15993\\_RONDA-O](#) [FN15977\\_RONDA-WAS2](#)