

AMY-70-W-C

~36° wide beam. Assembly with holder C compatible with HEKLA sockets and connectors. Black version.

TECHNICAL SPECIFICATIONS:

Dimensions	∅ mm
Height	0 mm
ROHS compliant	yes ⓘ



MATERIAL SPECIFICATIONS:

Component	Type	Material	Colour	Finish
AMY-70-W	Single lens	PMMA		
AMY-70-HLD-C	Holder	PC		

ORDERING INFORMATION:

Component	Qty in box	MOQ	MPQ	Box weight (kg)
CP17784_AMY-70-W-C » Box size: 480 x 280 x 300 mm	210	210	15	8.4

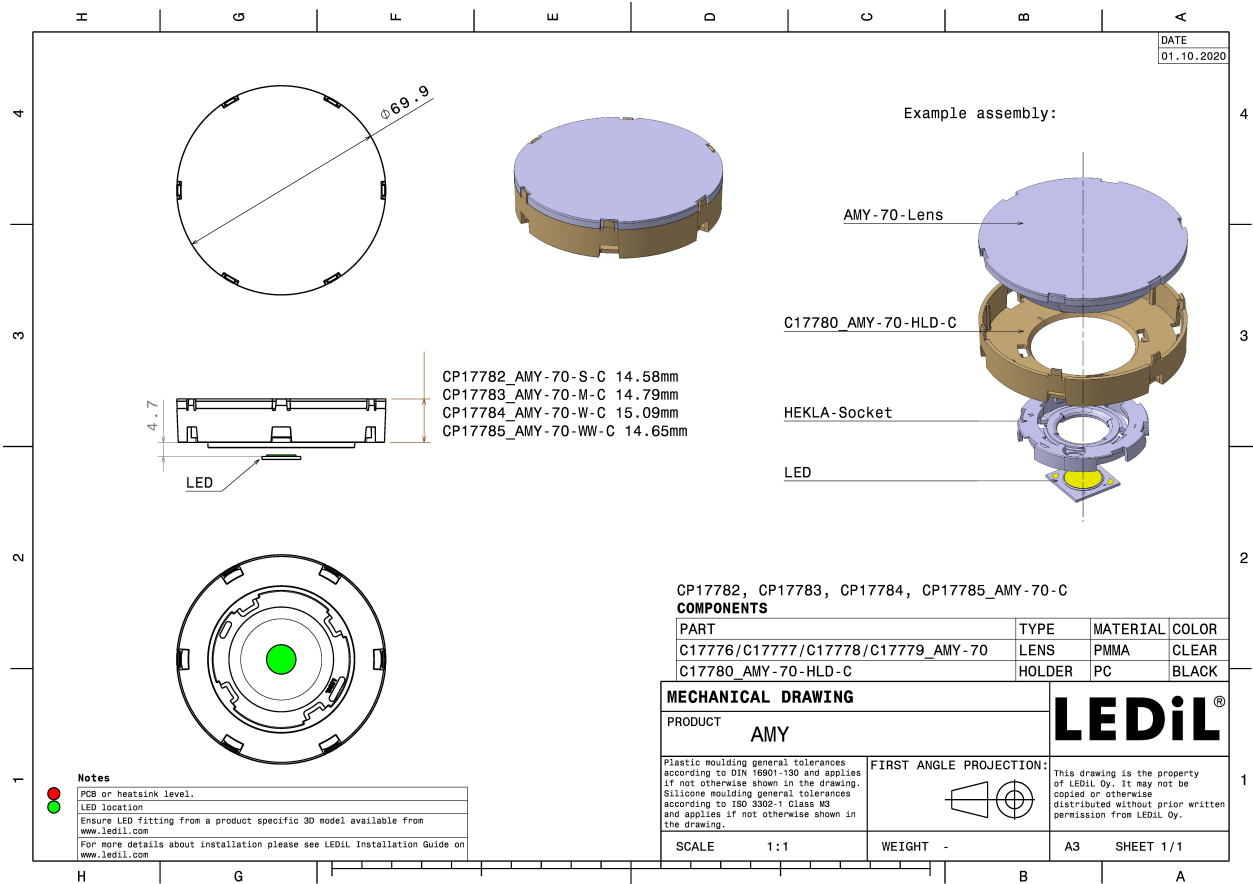

See also our general installation guide: www.ledil.com/installation_guide

PHOTOMETRIC DATA (MEASURED):

CITIZEN

LED CLL02x/CLU02x (LES10)
 FWHM / FWTM 35.0° / 59.0°
 Efficiency 88 %
 Peak intensity 2.1 cd/lm
 LEDs/each optic 1
 Light colour White
 Required components:
 F17435_HEKLA-G2-C

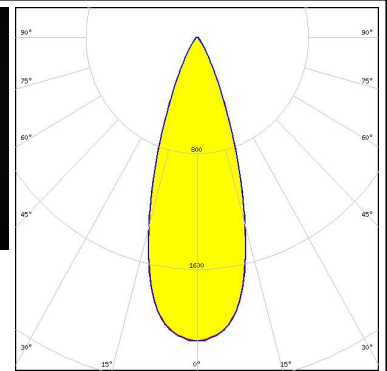
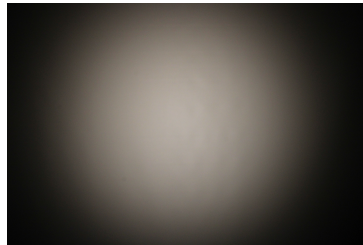

CREE LED

LED CMU15xx
 FWHM / FWTM 38.0° / 66.0°
 Efficiency 86 %
 Peak intensity 1.7 cd/lm
 LEDs/each optic 1
 Light colour White
 Required components:
 F17438_HEKLA-G2-I

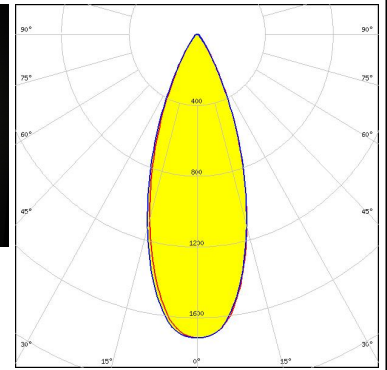
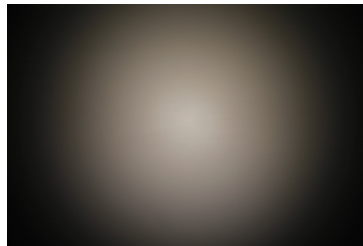

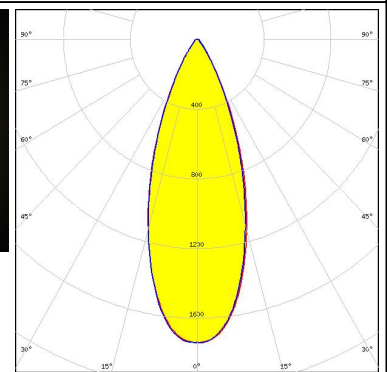
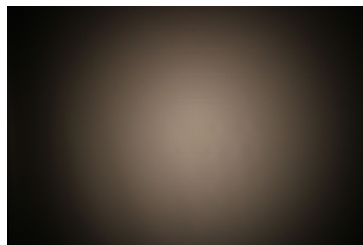

SAMSUNG

LED LC016D / LC019D / LC026D / LC033D
 FWHM / FWTM 38.0° / 66.0°
 Efficiency 88 %
 Peak intensity 1.7 cd/lm
 LEDs/each optic 1
 Light colour White
 Required components:
 F15859_HEKLA-SOCKET-I

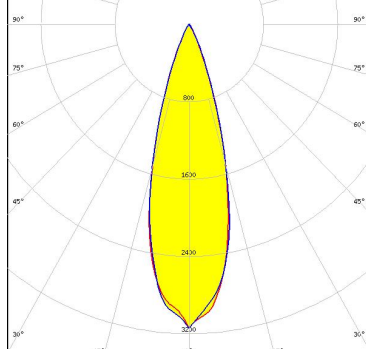

PHOTOMETRIC DATA (SIMULATED):

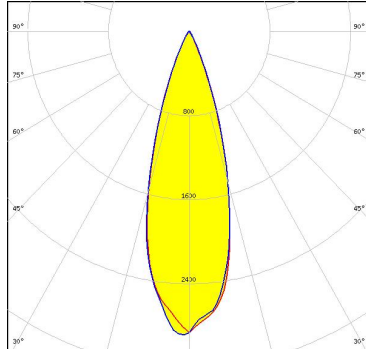
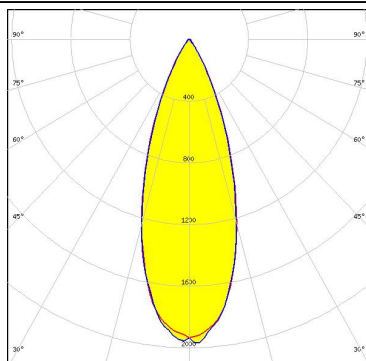
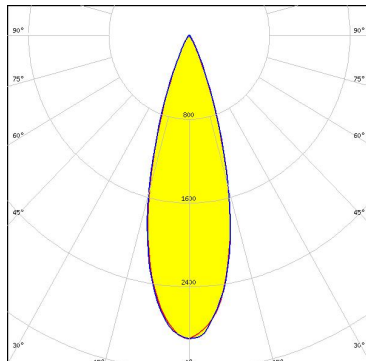
<p></p> <p>LED V8 Gen7 FWHM / FWTM 30.0° / 50.0° Efficiency 90 % Peak intensity 3.1 cd/lm LEDs/each optic 1 Light colour White Required components: F15253_HEKLA-SOCKET-A</p>	
<p></p> <p>LED VERO10 FWHM / FWTM 31.0° / 52.0° Efficiency 89 % Peak intensity 2.9 cd/lm LEDs/each optic 1 Light colour White Required components: F15616_HEKLA-SOCKET-F</p>	
<p>CITIZEN</p> <p>LED CLL03x/CLU03x FWHM / FWTM 36.0° / 64.0 + 63.0° Efficiency 87 % Peak intensity 2 cd/lm LEDs/each optic 1 Light colour White Required components: F15859_HEKLA-SOCKET-I</p>	
<p>CITIZEN</p> <p>LED CLU700/701/702 FWHM / FWTM 30.0 + 31.0° / 52.0° Efficiency 90 % Peak intensity 2.9 cd/lm LEDs/each optic 1 Light colour White Required components: F15255_HEKLA-SOCKET-C</p>	

PHOTOMETRIC DATA (SIMULATED):

CITIZEN

LED CLU700/701/702
 FWHM / FWTM 30.0 + 31.0° / 50.0°
 Efficiency 91 %
 Peak intensity 3 cd/lm
 LEDs/each optic 1
 Light colour White
 Required components:
 F15255_HEKLA-SOCKET-C

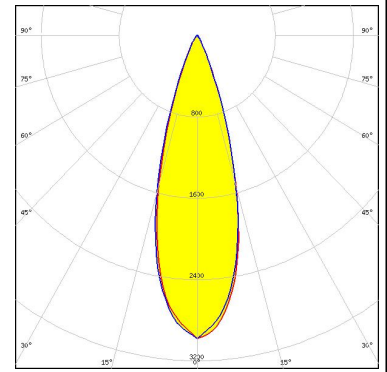

CREE LED

LED CXA/B 15xx
 FWHM / FWTM 33.0 + 32.0° / 54.0 + 55.0°
 Efficiency 88 %
 Peak intensity 2.6 cd/lm
 LEDs/each optic 1
 Light colour White
 Required components:
 F15256_HEKLA-SOCKET-D

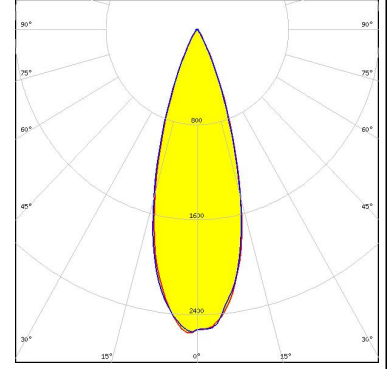

PHILIPS

LED Fortimo SLM L15 CoB
 FWHM / FWTM 34.0° / 60.0°
 Efficiency 89 %
 Peak intensity 2.2 cd/lm
 LEDs/each optic 1
 Light colour White
 Required components:
 Bender Wirth: 632a Hekla XL

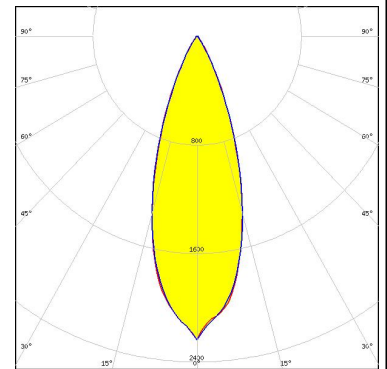

SAMSUNG

LED LC003D / LC006D / LC009D / LC013D
 FWHM / FWTM 32.0 + 33.0° / 56.0°
 Efficiency 90 %
 Peak intensity 2.6 cd/lm
 LEDs/each optic 1
 Light colour White
 Required components:
 F15255_HEKLA-SOCKET-C

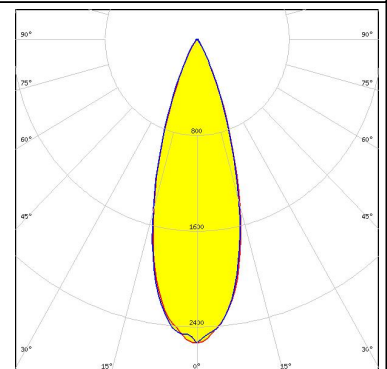

PHOTOMETRIC DATA (SIMULATED):

SAMSUNG

LED	LC020T (Tunable white)
FWHM / FWTM	34.0° / 58.0°
Efficiency	89 %
Peak intensity	2.3 cd/lm
LEDs/each optic	1
Light colour	White
Required components:	
	F15859_HEKLA-SOCKET-I

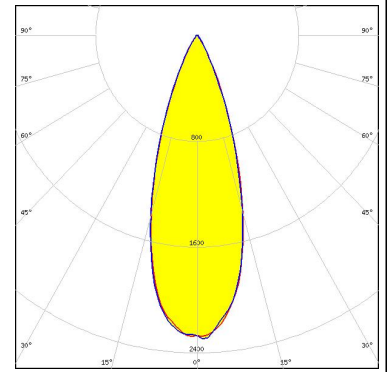

GENERAL INFORMATION:

NOTE: The typical beam angle will be changed by different color, chip size and chip position tolerance. The typical total beam angle is the full angle measured where the luminous intensity is half of the peak value.

Due to use of high power COB's with this product, special attention to proper thermal design is highly recommended. LEDiL has no liability for direct, indirect or consecutive damages arising from the LEDiL products being used outside of the recommended temperature range.

MATERIALS:

As part of our continuous research and improvement processes, and to ensure the best possible quality and availability of our products, LEDiL reserves the right to change material grades without notice.

PRODUCT DATA USER AGREEMENT AND DISCLAIMER:

The measured data in the provided downloadable LEDiL Product Datasheets and Mechanical 2D-Drawings is rounded and provided as reference for planning. LEDiL Oy's optical specifications have been verified by conducting performance testing of the products in accordance with the company's quality system. The reported data are averaged results of multiple measurements with typical variation. LEDiL Oy reserves the right to without prior notification make changes and improvements to its products.

LEDiL Oy assumes neither warranty, nor guarantee nor any other liability of any kind for the contents and correctness of the provided data. The provided data has been generated with highest diligence but the provided data may in reality not represent the complete possible variation range of all intrinsic parameters. Therefore, in certain cases a deviation from the provided data could occur.

LEDiL Oy reserves the right to undertake technical changes of its products without further notification which could lead to changes in the provided data. LEDiL Oy assumes no liability of any kind for the possible deviation from any provided data or any other damage resulting from the usage of the provided data.

The user agrees to this disclaimer and user agreement with the download or usage of the provided files.

LEDiL Oy

Joensuunkatu 13
FI-24240 SALO
Finland

LEDiL Inc.

228 West Page Street
Suite D
Sycamore IL 60178
USA

Ledil Optics Technology (Shenzhen) Co., Ltd.

405 , Block B
Casic Motor Building
Shenzhen 518057
P.R.CHINA

Local sales and technical support

[www.ledil.com/
where_to_buy](http://www.ledil.com/where_to_buy)

Shipping locations

Salo, Finland
Hong Kong, China

Distribution Partners

[www.ledil.com/
where_to_buy](http://www.ledil.com/where_to_buy)

X-ON Electronics

Largest Supplier of Electrical and Electronic Components

Click to view similar products for [LED Lighting Lenses](#) category:

Click to view products by [Ledil](#) manufacturer:

Other Similar products are found below :

[LL01ED-AK40L06](#) [LL01ZZ-EX25L06-M2](#) [180182-0000](#) [LL01ED-ALI55R49](#) [C14707_IDA16-O](#) [LL01ED-AKY24R49](#) [LL01CR-AYG15R49](#) [LL01CR-OT32L06-M2](#) [LL01ZZ-AAA24L49](#) [LL01CR-CEN38L02](#) [LL01ZZ-AAA55L49](#) [LL01CR-AYG24R49](#)
[LL01A00CZMB2-M2](#) [LL01ED-AKY38R49](#) [LL01CR-CNE2545L06-M2](#) [LL01ZZ-AAA38L49](#) [LL01ED-AKV36R49](#) [LL01ED-ALI24R49](#)
[LL01CR-AYG38R49](#) [C17171_DAISSY-8X1-SHD-MATT](#) [F16859_LINDA-ZT25](#) [C17295_ILONA-ZOOM](#) [F16636_LINDA-W60](#)
[C16871_DAISSY-7X1-W](#) [C18165_AMY-35-ZOOM-SUB](#) [10003](#) [10003/15](#) [10048](#) [10049](#) [10108](#) [F14487_FLORENCE-1R-MAXI-WG](#) [12667](#)
[C14605_HB-2X2-RW](#) [C14642_FLORENCE-1R-UP](#) [CAY033](#) [CAY046/55](#) [OS-LRI2015X45S](#) [OSOLRA2015M](#) [PG1C-NX36](#) [PG1C-SX17](#)
[PM2A-SXV1](#) [PM2B-NX55-AW](#) [PM6A-FN25](#) [FC2231-0000-0050-L](#) [FC2231-0000-0100-L](#) [C14116_STRADA-2X2-PX](#) [C12345_HB-5X1-W](#)
[95-0931](#) [C15800_MOLLY-S](#) [C15802_MOLLY-W](#)