

ANGELINA-S

~20° spot beam

TECHNICAL SPECIFICATIONS:

Dimensions	Ø 82.0 mm
Height	31 mm
Fastening	socket
ROHS compliant	yes ⓘ

MATERIAL SPECIFICATIONS:

Component	Type	Material	Colour	Finish	Coating
ANGELINA-S	Reflector	PC	metal		HMDS



ORDERING INFORMATION:

Component	Qty in box	MOQ	MPQ	Box weight (kg)
F13325_ANGELINA-S » Box size: 480 x 280 x 300 mm	900	120	60	12.7

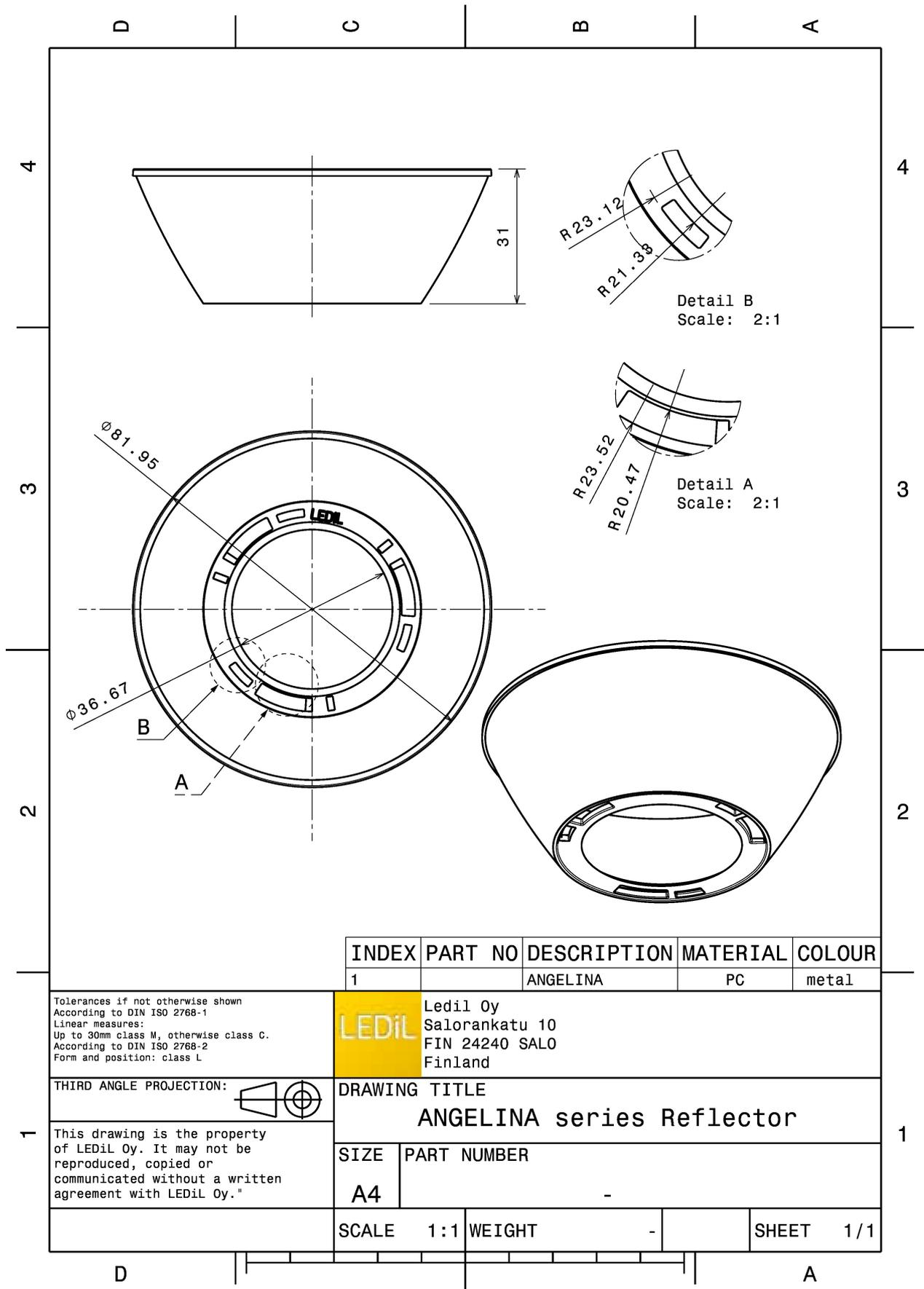

INDEX	PART NO	DESCRIPTION	MATERIAL	COLOUR
1		ANGELINA	PC	metal

Tolerances if not otherwise shown
According to DIN ISO 2768-1
Linear measures:
Up to 30mm class M, otherwise class C.
According to DIN ISO 2768-2
Form and position: class L

LEDiL Ledil Oy
Salorankatu 10
FIN 24240 SALO
Finland

THIRD ANGLE PROJECTION:

DRAWING TITLE
ANGELINA series Reflector

This drawing is the property of LEDiL Oy. It may not be reproduced, copied or communicated without a written agreement with LEDiL Oy."

SIZE	PART NUMBER
A4	-

SCALE	1:1	WEIGHT	-	SHEET	1/1
-------	-----	--------	---	-------	-----

See also our general installation guide: www.ledil.com/installation_guide

PHOTOMETRIC DATA (MEASURED):

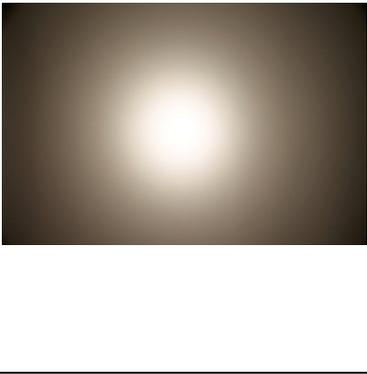
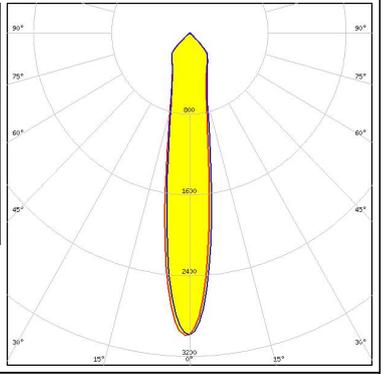
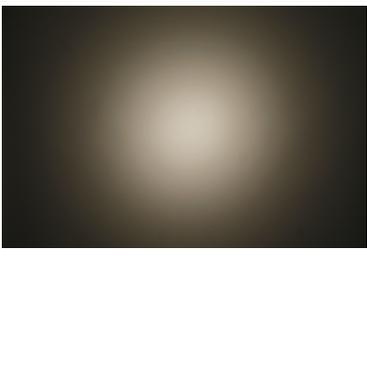
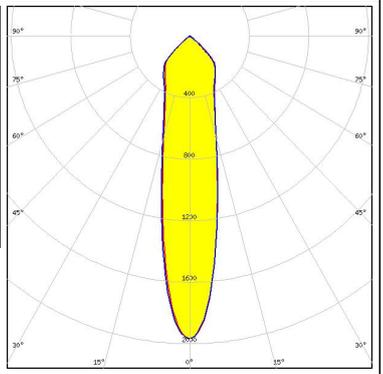
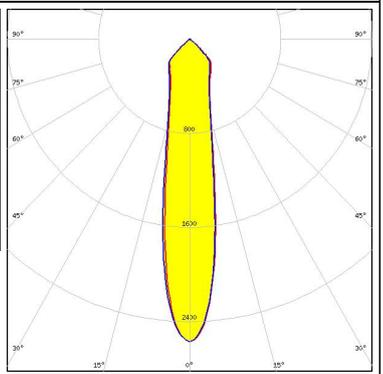
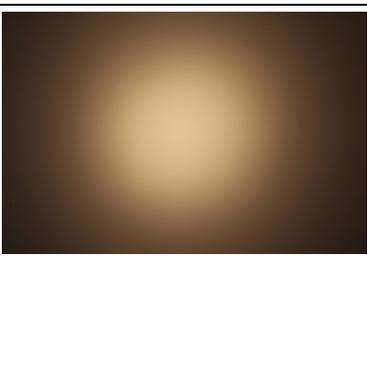
<p></p> <p>LED BXRA ES Rectangle FWHM / FWTM 17.0° / 75.0° Efficiency 94 % Peak intensity 3 cd/lm LEDs/each optic 1 Light colour White Required components: IDEAL: 50-2100BL + 50-2100AN</p>		
<p></p> <p>LED V10 Gen7 FWHM / FWTM 22.0° / 92.0° Efficiency 88 % Peak intensity 2 cd/lm LEDs/each optic 1 Light colour White Required components: C13658_CLAMP-VERO13-18 F13671_ANGE-RZ-LENS Bender Wirth: 434 Typ L1</p>		
<p></p> <p>LED V13 Gen7 FWHM / FWTM 20.0° / 87.0° Efficiency 94 % Peak intensity 2.6 cd/lm LEDs/each optic 1 Light colour White Required components: TE Connectivity: 2213254-2 + OPTIC CLIP Z50 TYPE1 2213194-1</p>		
<p></p> <p>LED V15 Gen6 FWHM / FWTM 23.0° / 94.0° Efficiency 88 % Peak intensity 2.4 cd/lm LEDs/each optic 1 Light colour White Required components: C13658_CLAMP-VERO13-18 Bender Wirth: 456 Typ L2</p>		

PHOTOMETRIC DATA (MEASURED):

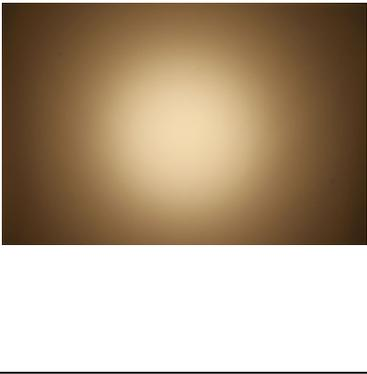
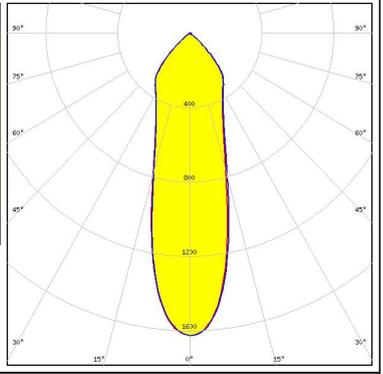
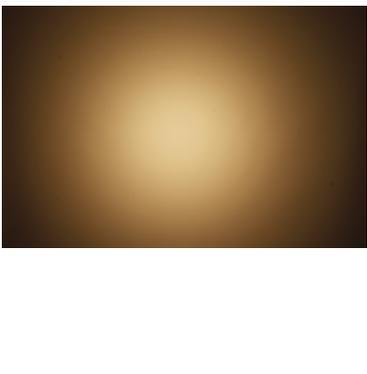
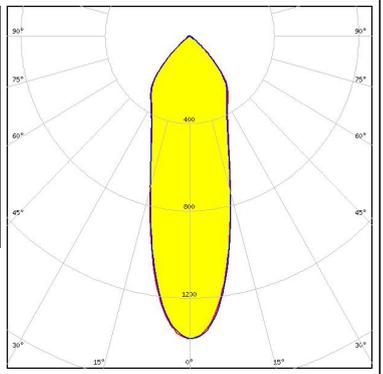
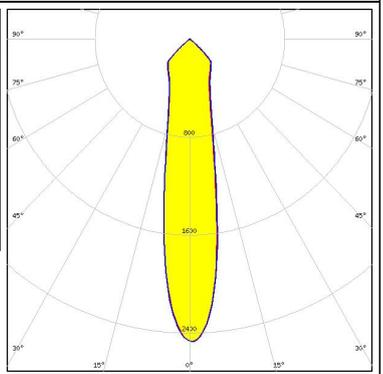
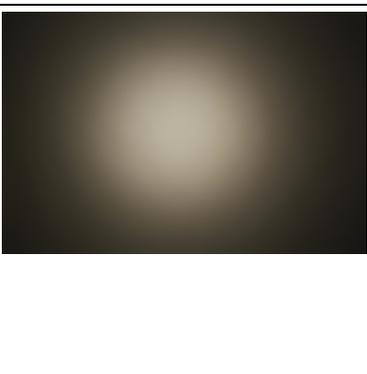
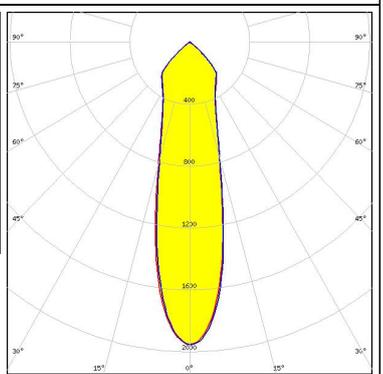
<p></p> <p>LED V22 Gen6 FWHM / FWTM 29.0° / 91.0° Efficiency 92 % Peak intensity 1.6 cd/lm LEDs/each optic 1 Light colour White Required components: IDEAL: 50-2204-CT + 50-2100AN</p>		
<p></p> <p>LED V22 Gen6 FWHM / FWTM 32.0° / 93.0° Efficiency 88 % Peak intensity 1.4 cd/lm LEDs/each optic 1 Light colour White Required components: F13671_ANGE-RZ-LENS IDEAL: 50-2204-CT + 50-2100AN</p>		
<p></p> <p>LED Vero SE 13 FWHM / FWTM 20.0° / 89.0° Efficiency 94 % Peak intensity 2.5 cd/lm LEDs/each optic 1 Light colour White Required components: C16402_CLAMP-VEROSE-13-18</p>		
<p></p> <p>LED Vero SE 18 FWHM / FWTM 26.0° / 91.0° Efficiency 94 % Peak intensity 2 cd/lm LEDs/each optic 1 Light colour White Required components: C16402_CLAMP-VEROSE-13-18</p>		

PHOTOMETRIC DATA (MEASURED):

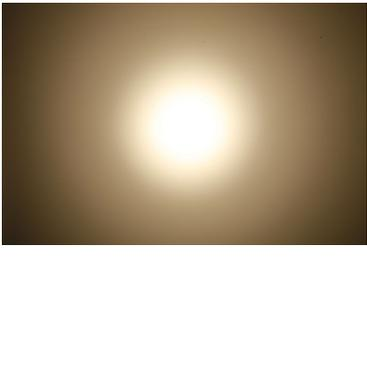
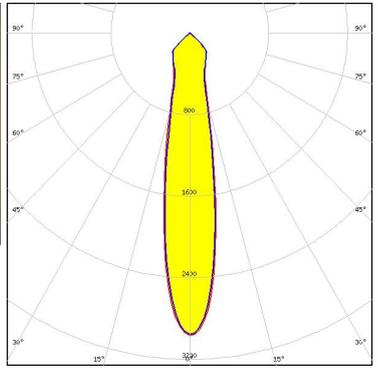
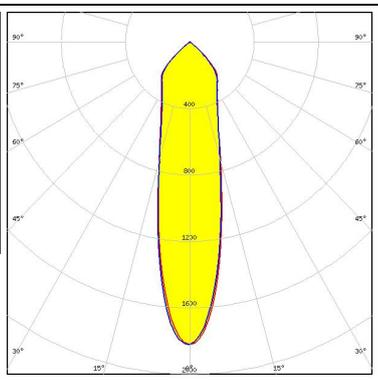
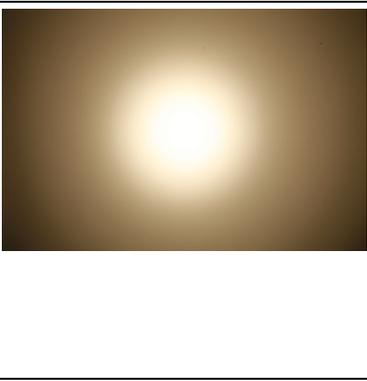
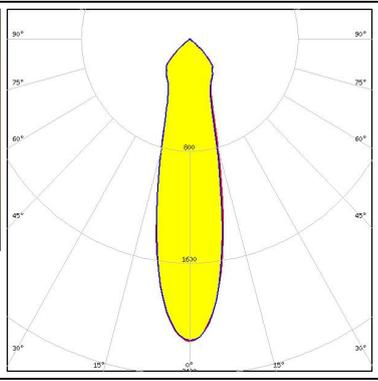
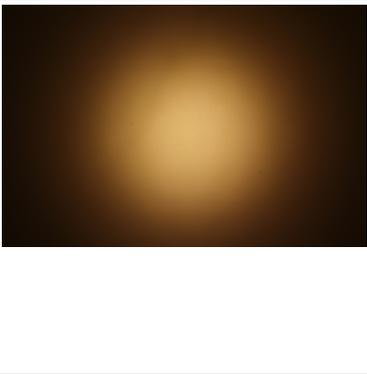
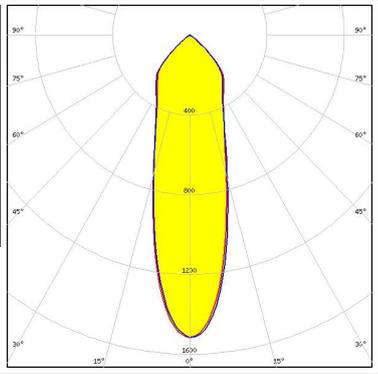
<p>bridgelux.</p> <p>LED VERO13 FWHM / FWTM 20.0° / 68.0° Efficiency 93 % Peak intensity 3 cd/m LEDs/each optic 1 Light colour White Required components: C13658_CLAMP-VERO13-18</p>		
<p>bridgelux.</p> <p>LED VERO13 FWHM / FWTM 25.0° / 92.0° Efficiency 88 % Peak intensity 1.8 cd/m LEDs/each optic 1 Light colour White Required components: C13658_CLAMP-VERO13-18 F13671_ANGE-RZ-LENS</p>		
<p>bridgelux.</p> <p>LED VERO18 FWHM / FWTM 25.0° / 88.0° Efficiency 92 % Peak intensity 2.2 cd/m LEDs/each optic 1 Light colour White Required components: C13658_CLAMP-VERO13-18</p>		
<p>bridgelux.</p> <p>LED VERO18 FWHM / FWTM 29.0° / 94.0° Efficiency 89 % Peak intensity 1.5 cd/m LEDs/each optic 1 Light colour White Required components: C13658_CLAMP-VERO13-18 F13671_ANGE-RZ-LENS</p>		

PHOTOMETRIC DATA (MEASURED):

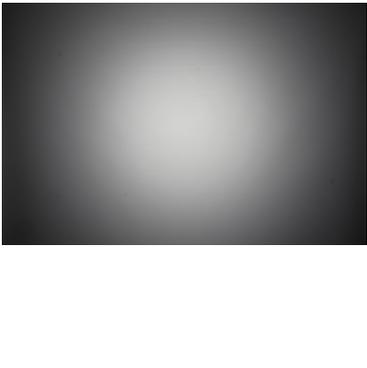
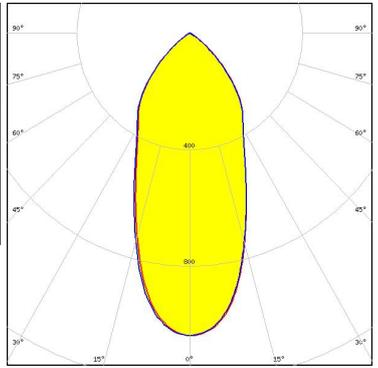
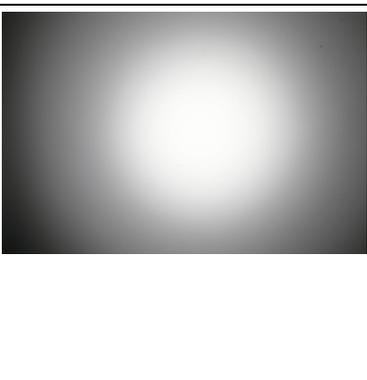
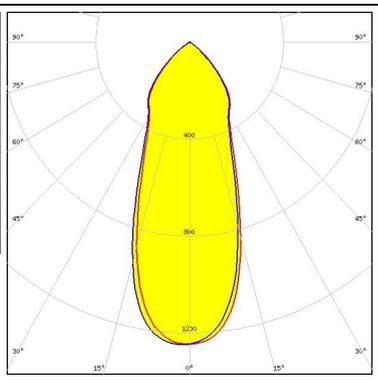
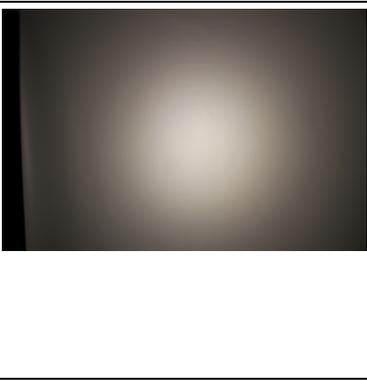
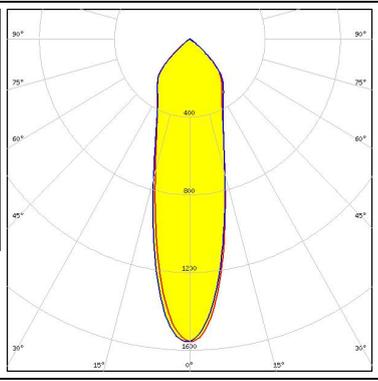
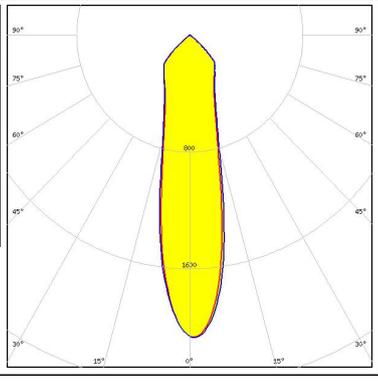
<p></p> <p>LED VERO29 FWHM / FWTM 44.0° / 99.0° Efficiency 89 % Peak intensity 1 cd/lm LEDs/each optic 1 Light colour White</p> <p>Required components: C13584_CLAMP-VERO29 F13671_ANGE-RZ-LENS</p>		
<p></p> <p>LED VERO29 FWHM / FWTM 39.0° / 96.0° Efficiency 90 % Peak intensity 1.2 cd/lm LEDs/each optic 1 Light colour White</p> <p>Required components: C13584_CLAMP-VERO29</p>		
<p></p> <p>LED Vesta TW 15mm DP FWHM / FWTM 28.0° / 94.0° Efficiency 89 % Peak intensity 1.6 cd/lm LEDs/each optic 1 Light colour Tunable White</p> <p>Required components: C13658_CLAMP-VERO13-18 F13671_ANGE-RZ-LENS Bender Wirth: 482 Typ L2</p>		
<p></p> <p>LED Vesta TW 15mm DP FWHM / FWTM 24.0° / 90.0° Efficiency 92 % Peak intensity 2.1 cd/lm LEDs/each optic 1 Light colour Tunable White</p> <p>Required components: C13658_CLAMP-VERO13-18 Bender Wirth: 482 Typ L2</p>		

PHOTOMETRIC DATA (MEASURED):

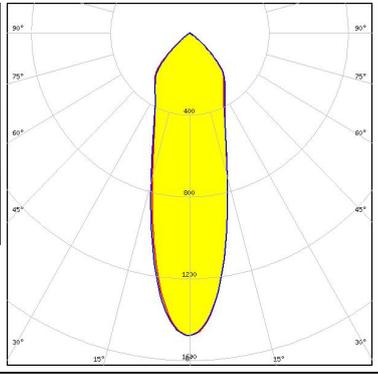
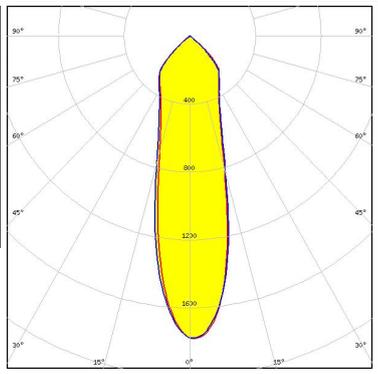
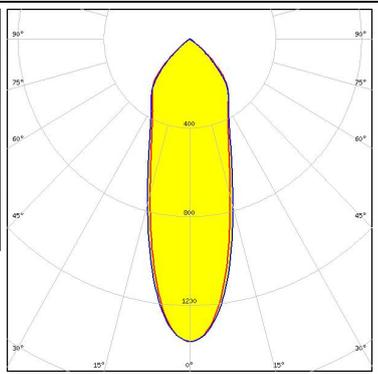
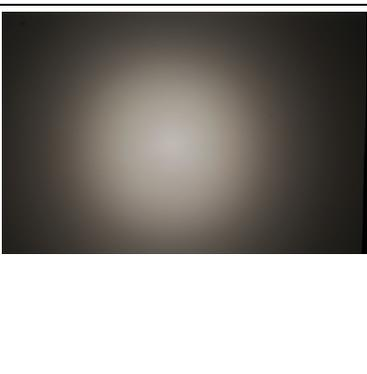
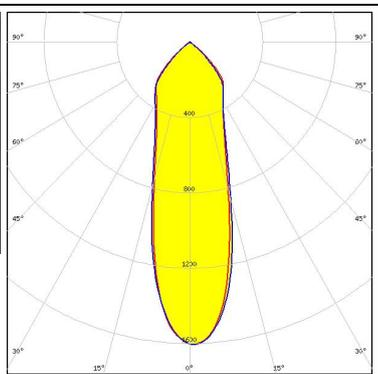
<p></p> <p>LED Vesta TW 18mm (31W) DP</p> <p>FWHM / FWTM 30.0° / 94.0°</p> <p>Efficiency 89 %</p> <p>Peak intensity 1.5 cd/lm</p> <p>LEDs/each optic 1</p> <p>Light colour Tunable White</p> <p>Required components: C13584_CLAMP-VERO29 F13671_ANGE-RZ-LENS Bender Wirth: 483 Typ L3</p>		
<p></p> <p>LED Vesta TW 18mm (31W) DP</p> <p>FWHM / FWTM 27.0° / 92.0°</p> <p>Efficiency 94 %</p> <p>Peak intensity 1.8 cd/lm</p> <p>LEDs/each optic 1</p> <p>Light colour Tunable White</p> <p>Required components: C13584_CLAMP-VERO29 Bender Wirth: 483 Typ L3</p>		
<p></p> <p>LED Vesta TW 22mm DP</p> <p>FWHM / FWTM 33.0° / 95.0°</p> <p>Efficiency 89 %</p> <p>Peak intensity 1.4 cd/lm</p> <p>LEDs/each optic 1</p> <p>Light colour Tunable White</p> <p>Required components: C13584_CLAMP-VERO29 F13671_ANGE-RZ-LENS Bender Wirth: 494 Typ L3</p>		
<p></p> <p>LED Vesta TW 22mm DP</p> <p>FWHM / FWTM 30.0° / 93.0°</p> <p>Efficiency 94 %</p> <p>Peak intensity 1.6 cd/lm</p> <p>LEDs/each optic 1</p> <p>Light colour Tunable White</p> <p>Required components: C13584_CLAMP-VERO29 Bender Wirth: 494 Typ L3</p>		

PHOTOMETRIC DATA (MEASURED):

CITIZEN

LED CLL02x/CLU02x (LES10)
 FWHM / FWTM 17.0° / 75.0°
 Efficiency 93 %
 Peak intensity 2.9 cd/lm
 LEDs/each optic 1
 Light colour White
 Required components:
 C13658_CLAMP-VERO13-18
 Bender Wirth: 434 Typ L1

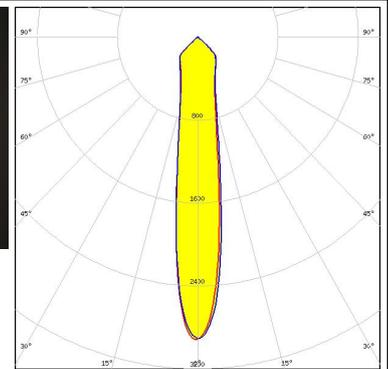

CITIZEN

LED CLL03x/CLU03x
 FWHM / FWTM 20.0° / 88.0°
 Efficiency 94 %
 Peak intensity 2.5 cd/lm
 LEDs/each optic 1
 Light colour White
 Required components:
 C16791_CLAMP-Z45-A
 TE Connectivity: 2325807-3

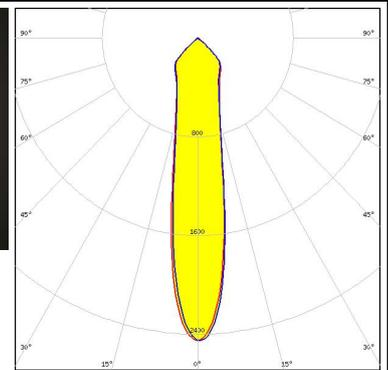

CITIZEN

LED CLL03x/CLU03x
 FWHM / FWTM 23.0° / 91.0°
 Efficiency 91 %
 Peak intensity 1.9 cd/lm
 LEDs/each optic 1
 Light colour White
 Required components:
 C16791_CLAMP-Z45-A
 F13671_ANGE-RZ-LENS
 TE Connectivity: 2325807-3

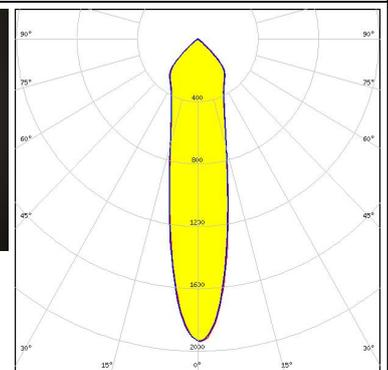

CITIZEN

LED CLL03x/CLU03x
 FWHM / FWTM 19.0° / 83.0°
 Efficiency 94 %
 Peak intensity 2.7 cd/lm
 LEDs/each optic 1
 Light colour White
 Required components:
 IDEAL: 50-2103CT + 50-2100AN

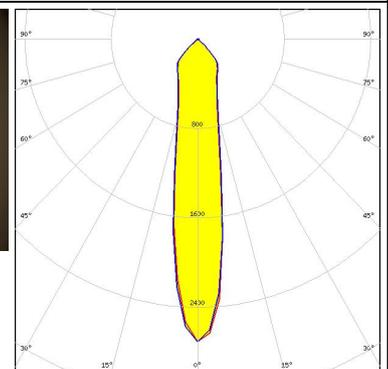

PHOTOMETRIC DATA (MEASURED):

CITIZEN

LED CLL03x/CLU03x
 FWHM / FWTM 21.0° / 89.0°
 Efficiency 92 %
 Peak intensity 2.3 cd/lm
 LEDs/each optic 1
 Light colour White
 Required components:
 C13658_CLAMP-VERO13-18
 Bender Wirth: 433 Typ L1

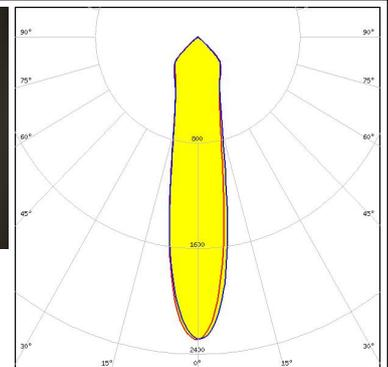

CITIZEN

LED CLL03x/CLU03x
 FWHM / FWTM 25.0° / 92.0°
 Efficiency 87 %
 Peak intensity 1.7 cd/lm
 LEDs/each optic 1
 Light colour White
 Required components:
 F13671_ANGE-RZ-LENS
 TE Connectivity: 2213254-2 + OPTIC CLIP Z50 TYPE1 2213194-1

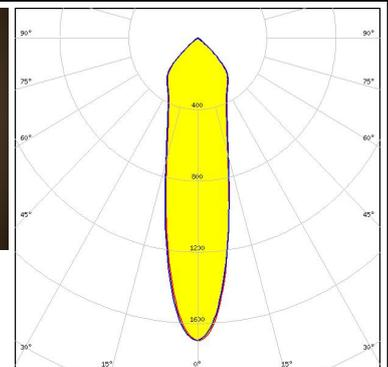

CITIZEN

LED CLL03x/CLU03x
 FWHM / FWTM 23.0° / 90.0°
 Efficiency 87 %
 Peak intensity 1.8 cd/lm
 LEDs/each optic 1
 Light colour White
 Required components:
 F13671_ANGE-RZ-LENS
 IDEAL: 50-2103CT + 50-2100AN

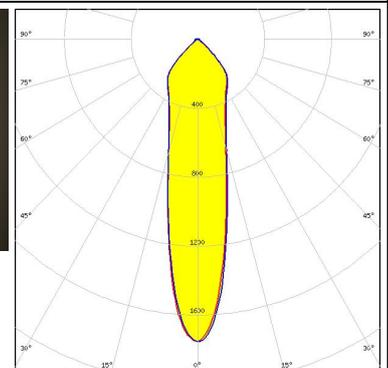

CITIZEN

LED CLL03x/CLU03x
 FWHM / FWTM 22.0° / 87.0°
 Efficiency 94 %
 Peak intensity 2.5 cd/lm
 LEDs/each optic 1
 Light colour White
 Required components:
 TE Connectivity: 2213254-2 + OPTIC CLIP Z50 TYPE1 2213194-1

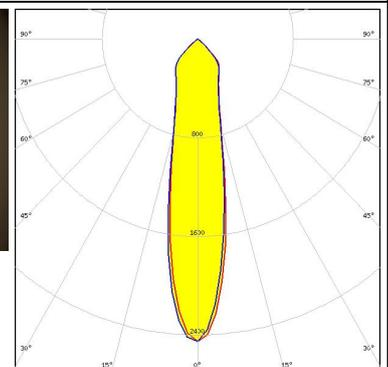

PHOTOMETRIC DATA (MEASURED):

CITIZEN

LED CLL04x/CLU04x
 FWHM / FWTM 30.0° / 91.0°
 Efficiency 92 %
 Peak intensity 1.6 cd/lm
 LEDs/each optic 1
 Light colour White
 Required components:
 IDEAL: 50-2204-CT + 50-2100AN

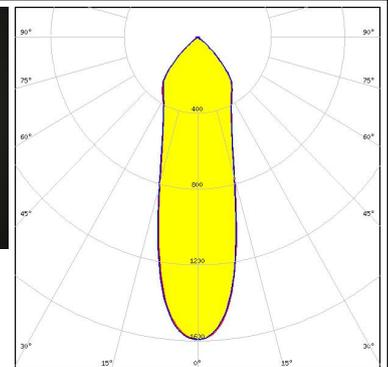

CITIZEN

LED CLL04x/CLU04x
 FWHM / FWTM 29.0° / 91.0°
 Efficiency 93 %
 Peak intensity 1.7 cd/lm
 LEDs/each optic 1
 Light colour White
 Required components:
 C13584_CLAMP-VERO29
 Bender Wirth: 431 Typ L3

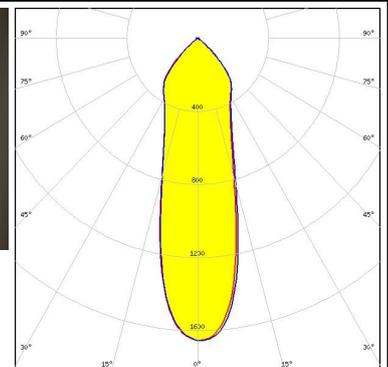

CITIZEN

LED CLL04x/CLU04x
 FWHM / FWTM 33.0° / 93.0°
 Efficiency 88 %
 Peak intensity 1.3 cd/lm
 LEDs/each optic 1
 Light colour White
 Required components:
 F13671_ANGE-RZ-LENS
 IDEAL: 50-2204-CT + 50-2100AN

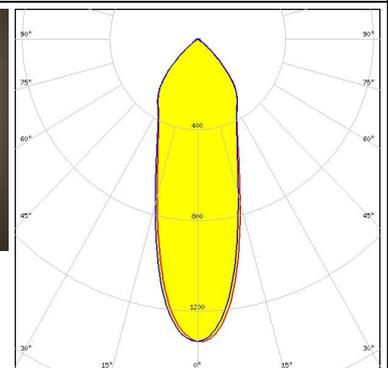
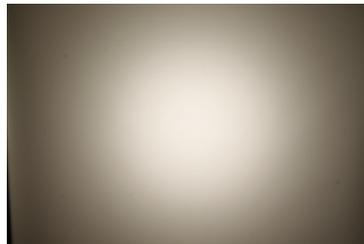

CITIZEN

LED CLU700/701/702
 FWHM / FWTM 14.0° / 56.0°
 Efficiency 93 %
 Peak intensity 3.7 cd/lm
 LEDs/each optic 1
 Light colour White
 Required components:
 C13658_CLAMP-VERO13-18
 Bender Wirth: 434 Typ L1

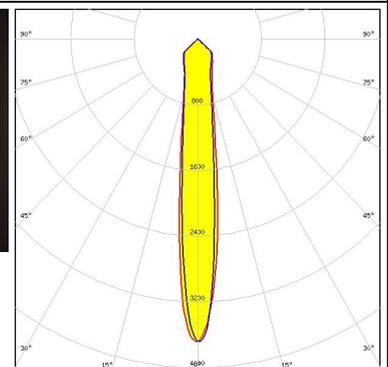

PHOTOMETRIC DATA (MEASURED):

CITIZEN

LED CLU720/721
 FWHM / FWTM 18.0° / 81.0°
 Efficiency 92 %
 Peak intensity 2.7 cd/lm
 LEDs/each optic 1
 Light colour White
 Required components:
 C13658_CLAMP-VERO13-18

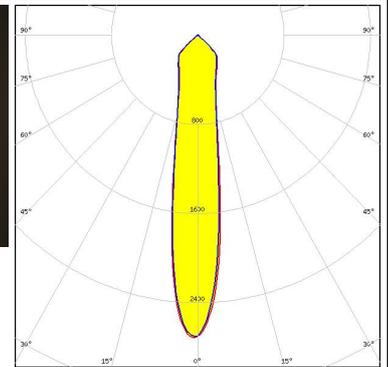
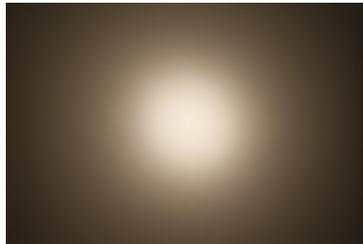

CITIZEN

LED CLU720/721
 FWHM / FWTM 15.0° / 75.0°
 Efficiency 94 %
 Peak intensity 3.1 cd/lm
 LEDs/each optic 1
 Light colour White
 Required components:
 IDEAL: 50-2103CT + 50-2100AN

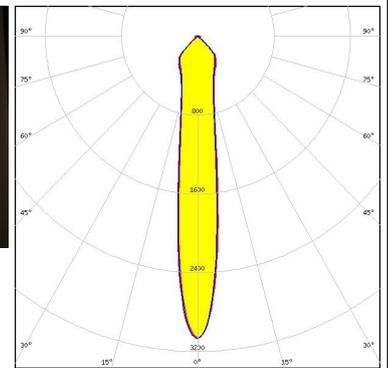

CITIZEN

LED CLU720/721
 FWHM / FWTM 17.0° / 84.0°
 Efficiency 94 %
 Peak intensity 2.7 cd/lm
 LEDs/each optic 1
 Light colour White
 Required components:
 TE Connectivity: 2213254-2 + OPTIC CLIP Z50 TYPE1 2213194-1

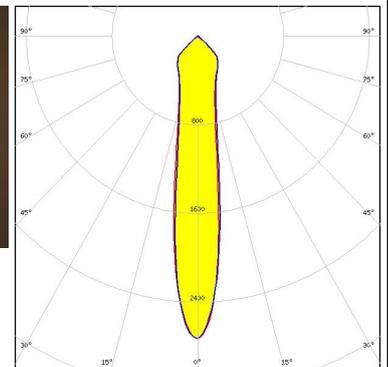
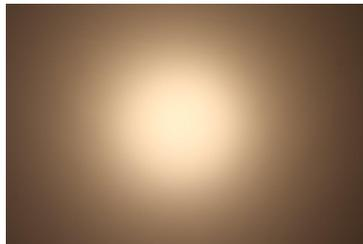

CITIZEN

LED CLU730/731
 FWHM / FWTM 18.0° / 84.0°
 Efficiency 92 %
 Peak intensity 2.7 cd/lm
 LEDs/each optic 1
 Light colour White
 Required components:
 IDEAL: 50-2204-CT + 50-2100AN

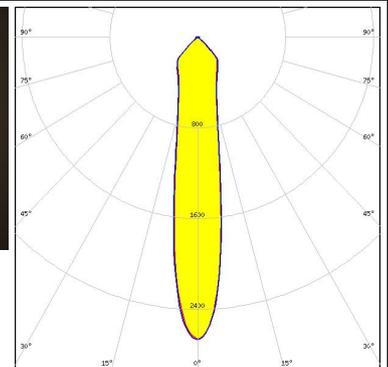

PHOTOMETRIC DATA (MEASURED):

CITIZEN

LED CLU730/731
 FWHM / FWTM 21.0° / 88.0°
 Efficiency 87 %
 Peak intensity 2.1 cd/lm
 LEDs/each optic 1
 Light colour White
 Required components:
 F13671_ANGE-RZ-LENS
 IDEAL: 50-2204-CT + 50-2100AN

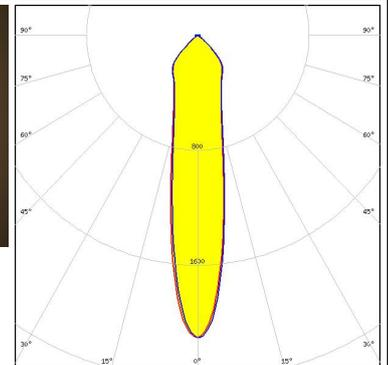

CITIZEN

LED CLU730/731
 FWHM / FWTM 18.0° / 84.0°
 Efficiency 92 %
 Peak intensity 2.7 cd/lm
 LEDs/each optic 1
 Light colour White
 Required components:
 IDEAL: 50-2204-CT + 50-2100AN

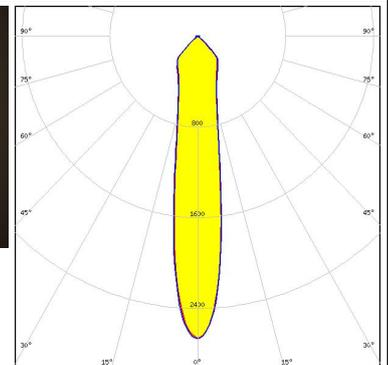

LED CMA1840
 FWHM / FWTM 22.0° / 88.0°
 Efficiency 95 %
 Peak intensity 2.5 cd/lm
 LEDs/each optic 1
 Light colour White
 Required components:
 C14123_CLAMP-CXA15-18

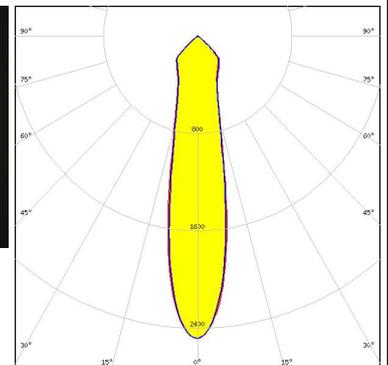

LED CMA2550
 FWHM / FWTM 26.0° / 90.0°
 Efficiency 94 %
 Peak intensity 2 cd/lm
 LEDs/each optic 1
 Light colour White
 Required components:
 C14036_CLAMP_CXA25-30

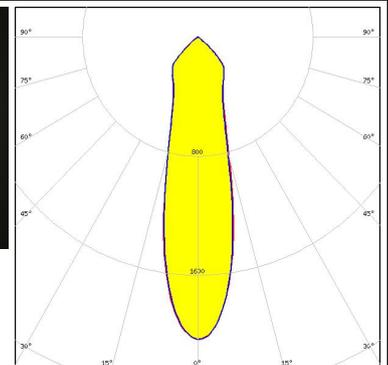

PHOTOMETRIC DATA (MEASURED):

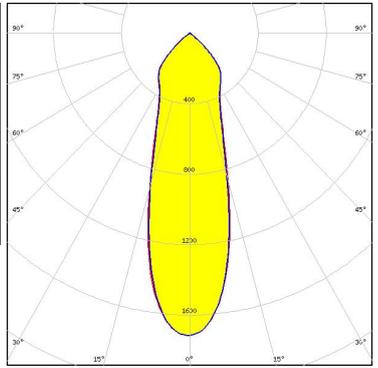
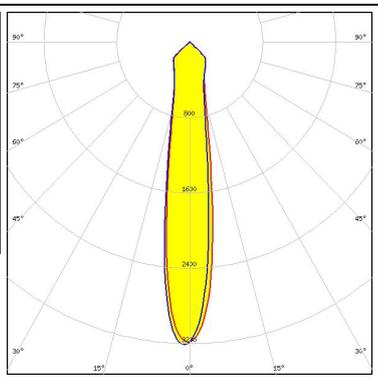
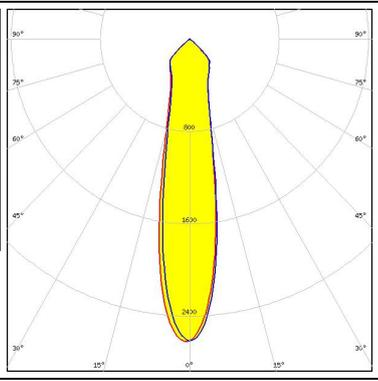
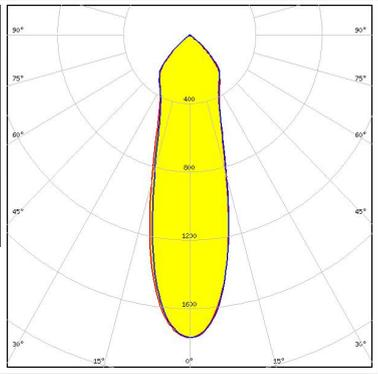
<p>CREE → LED</p> <p>LED CMA3090 FWHM / FWTM 30.0° / 92.0° Efficiency 94 % Peak intensity 1.7 cd/m LEDs/each optic 1 Light colour White Required components: C14036_CLAMP_CXA25-30</p>		
<p>CREE → LED</p> <p>LED CMT14xx FWHM / FWTM 17.0° / 65.0° Efficiency 94 % Peak intensity 3.2 cd/m LEDs/each optic 1 Light colour White Required components: C13658_CLAMP-VERO13-18 Bender Wirth: 434 Typ L1</p>		
<p>CREE → LED</p> <p>LED CMT19xx FWHM / FWTM 21.0° / 85.0° Efficiency 94 % Peak intensity 2.6 cd/m LEDs/each optic 1 Light colour White Required components: C13658_CLAMP-VERO13-18 Bender Wirth: 477 Typ L1</p>		
<p>CREE → LED</p> <p>LED CMT28xx FWHM / FWTM 29.0° / 91.0° Efficiency 94 % Peak intensity 1.8 cd/m LEDs/each optic 1 Light colour White Required components: C13584_CLAMP-VERO29 Bender Wirth: 471 Typ L3</p>		

PHOTOMETRIC DATA (MEASURED):



LED CXA/B 15xx
 FWHM / FWTM 15.0° / 65.0°
 Efficiency 93 %
 Peak intensity 3.3 cd/lm
 LEDs/each optic 1
 Light colour White
 Required components:
 C13658_CLAMP-VERO13-18
 Bender Wirth: 441 Typ L1

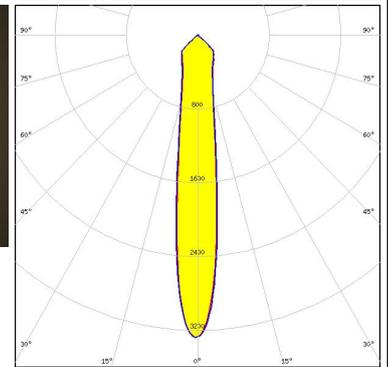

LED CXA/B 15xx
 FWHM / FWTM 20.0° / 81.0°
 Efficiency 94 %
 Peak intensity 2.8 cd/lm
 LEDs/each optic 1
 Light colour White
 Required components:
 C14123_CLAMP-CXA15-18

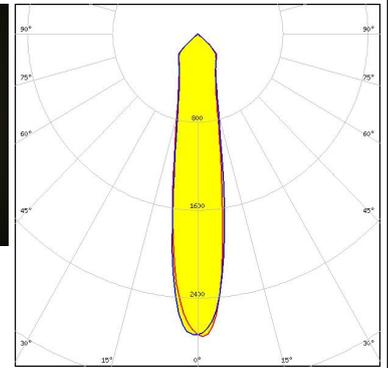

LED CXA/B 1816 & CXA/B 1820 & CXA 1850
 FWHM / FWTM 22.0° / 90.0°
 Efficiency 89 %
 Peak intensity 2 cd/lm
 LEDs/each optic 1
 Light colour White
 Required components:
 F13671_ANGE-RZ-LENS
 TE Connectivity: 2213401-2 + OPTIC CLIP Z50 TYPE1 2213194-1

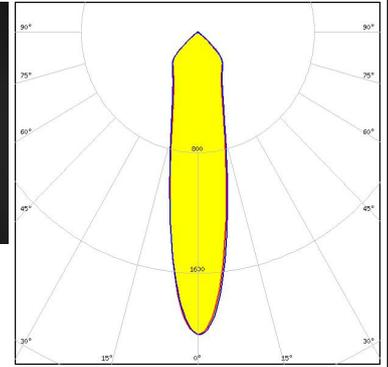
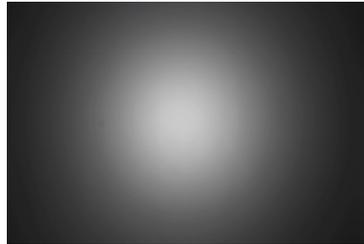

LED CXA/B 1816 & CXA/B 1820 & CXA 1850
 FWHM / FWTM 16.0° / 68.0°
 Efficiency 94 %
 Peak intensity 3.3 cd/lm
 LEDs/each optic 1
 Light colour White
 Required components:
 IDEAL: 50-2101CR + 50-2100AN

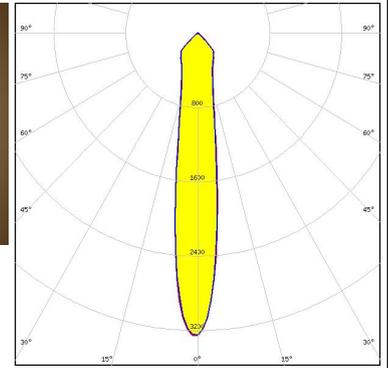
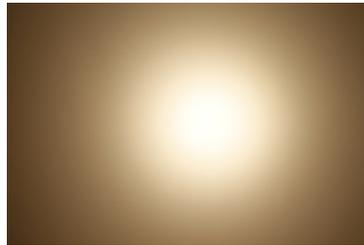

PHOTOMETRIC DATA (MEASURED):

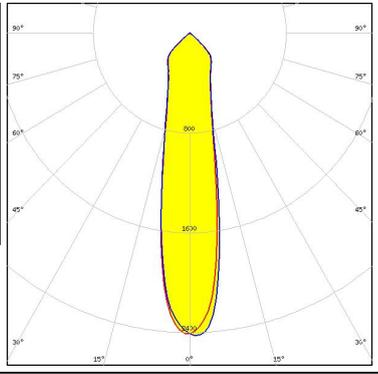
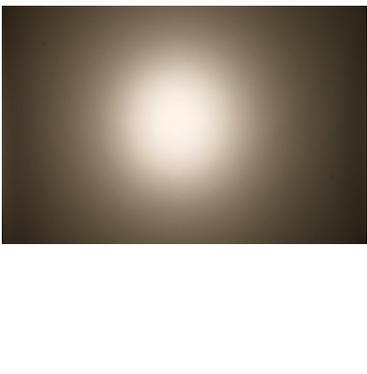
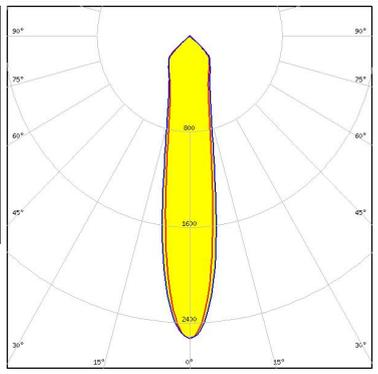
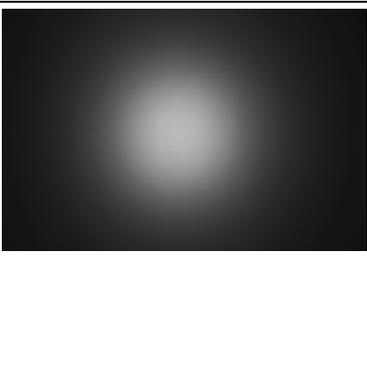
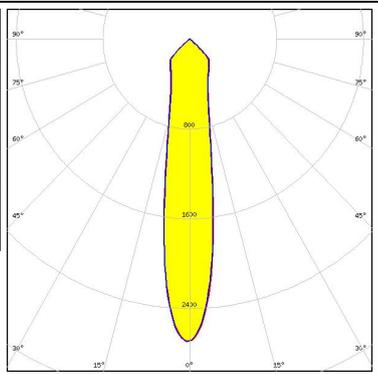
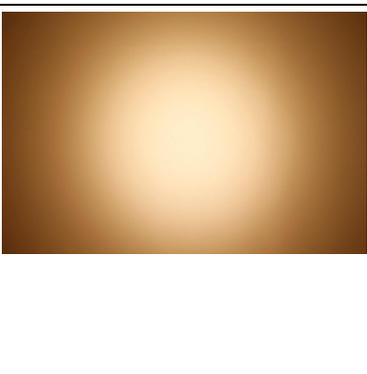
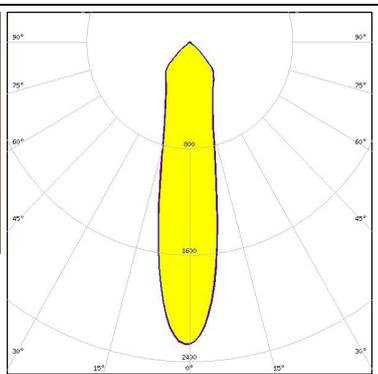
<p>CREE → LED</p> <p>LED CXA/B 1816 & CXA/B 1820 & CXA 1850 FWHM / FWTM 22.0° / 89.0° Efficiency 94 % Peak intensity 2.4 cd/m LEDs/each optic 1 Light colour White Required components: C14123_CLAMP-CXA15-18</p>		
<p>CREE → LED</p> <p>LED CXA/B 1816 & CXA/B 1820 & CXA 1850 FWHM / FWTM 19.0° / 87.0° Efficiency 93 % Peak intensity 2.5 cd/m LEDs/each optic 1 Light colour White Required components: C13658_CLAMP-VERO13-18 Bender Wirth: 437 Typ L1</p>		
<p>CREE → LED</p> <p>LED CXA/B 1816 & CXA/B 1820 & CXA 1850 FWHM / FWTM 19.0° / 83.0° Efficiency 93 % Peak intensity 2.7 cd/m LEDs/each optic 1 Light colour White Required components: TE Connectivity: 2213401-2 + OPTIC CLIP Z50 TYPE1 2213194-1</p>		
<p>CREE → LED</p> <p>LED CXA/B 25xx FWHM / FWTM 22.0° / 87.0° Efficiency 94 % Peak intensity 2.3 cd/m LEDs/each optic 1 Light colour White Required components: IDEAL: 50-2102CR + 50-2100AN</p>		

PHOTOMETRIC DATA (MEASURED):

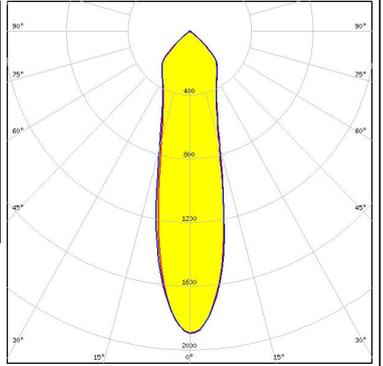
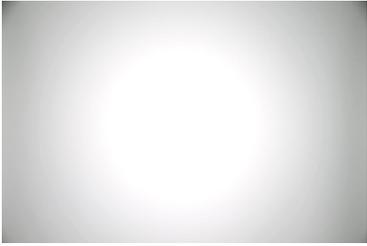
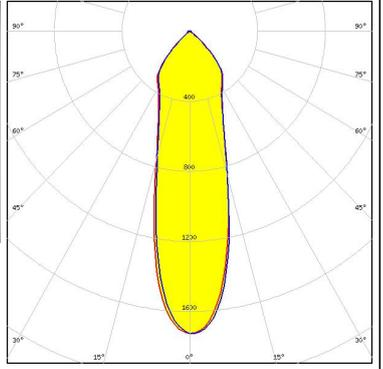
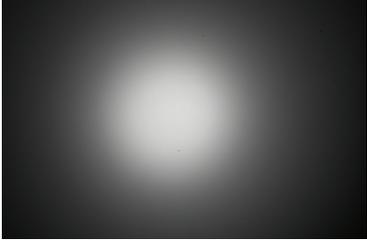
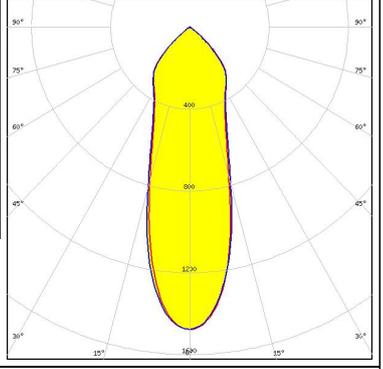
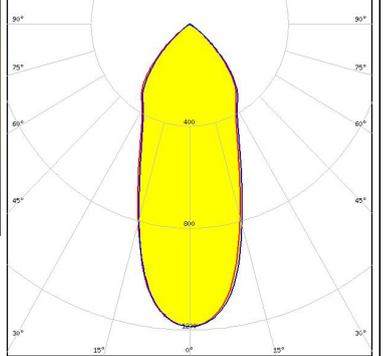
<p>CREE → LED</p> <p>LED CXA/B 25xx FWHM / FWTM 25.0° / 92.0° Efficiency 93 % Peak intensity 1.9 cd/m LEDs/each optic 1 Light colour White Required components: C14036_CLAMP_CXA25-30</p>		
<p>CREE → LED</p> <p>LED CXA/B 30xx FWHM / FWTM 28.0° / 89.0° Efficiency 94 % Peak intensity 1.7 cd/m LEDs/each optic 1 Light colour White Required components: IDEAL: 50-2234C + 50-2100AN</p>		
<p>CREE → LED</p> <p>LED CXA/B 30xx FWHM / FWTM 32.0° / 95.0° Efficiency 92 % Peak intensity 1.5 cd/m LEDs/each optic 1 Light colour White Required components: C14036_CLAMP_CXA25-30</p>		
<p>CREE → LED</p> <p>LED CXA/B 3590 FWHM / FWTM 40.0° / 97.0° Efficiency 93 % Peak intensity 1.2 cd/m LEDs/each optic 1 Light colour White Required components: IDEAL: 50-2303CR + 50-2300AN</p>		

PHOTOMETRIC DATA (MEASURED):

EVERLIGHT

LED CHI3030 19W
 FWHM / FWTM 29.0° / 90.0°
 Efficiency 88 %
 Peak intensity 1.5 cd/lm
 LEDs/each optic 1
 Light colour White
 Required components:
 C13584_CLAMP-VERO29
 F13671_ANGE-RZ-LENS
 Bender Wirth: 468 Typ L3



EVERLIGHT

LED CHI3030 29W
 FWHM / FWTM 39.0° / 90.0°
 Efficiency 88 %
 Peak intensity 1.3 cd/lm
 LEDs/each optic 1
 Light colour White
 Required components:
 C13584_CLAMP-VERO29
 F13671_ANGE-RZ-LENS
 Bender Wirth: 468 Typ L3

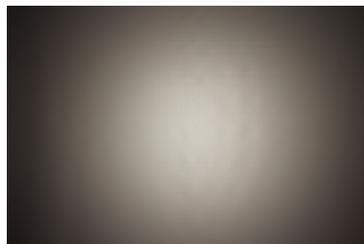

LUMILEDS

LED LUXEON CoB 1202/1203
 FWHM / FWTM 18.0° / 83.0°
 Efficiency 93 %
 Peak intensity 2.8 cd/lm
 LEDs/each optic 1
 Light colour White
 Required components:
 C13658_CLAMP-VERO13-18
 Bender Wirth: 438 Typ L1

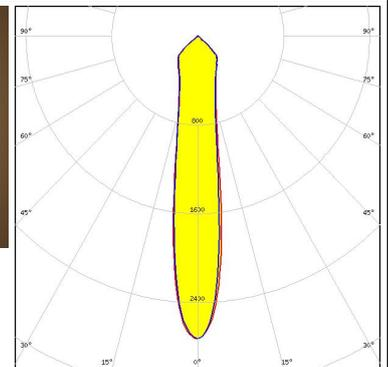

LUMILEDS

LED LUXEON CoB 1204/1205
 FWHM / FWTM 17.0° / 76.0°
 Efficiency 94 %
 Peak intensity 3 cd/lm
 LEDs/each optic 1
 Light colour White
 Required components:
 IDEAL: 50-2100SH + 50-2100AN

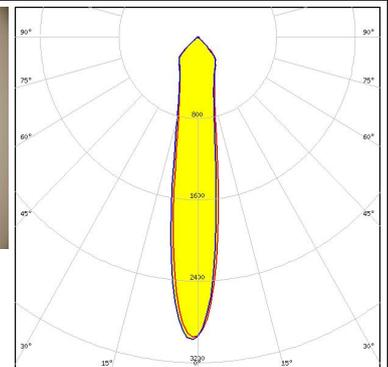
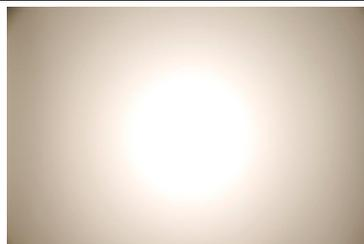

PHOTOMETRIC DATA (MEASURED):

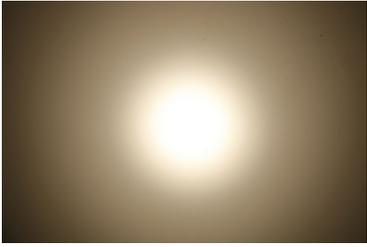
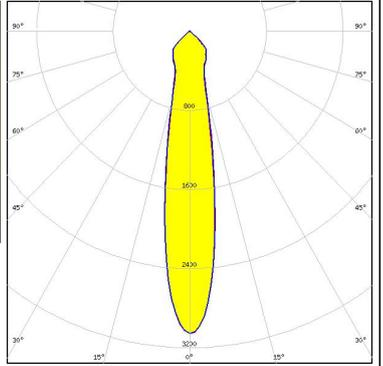
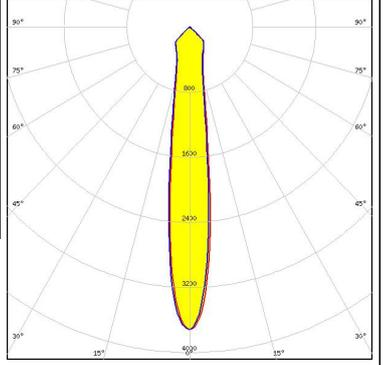
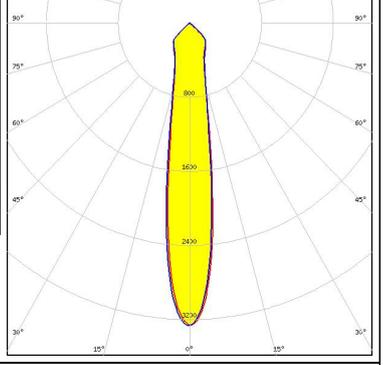
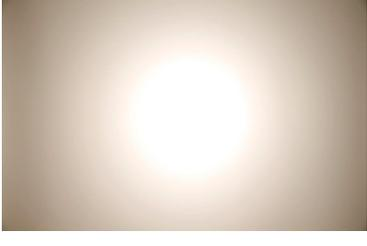
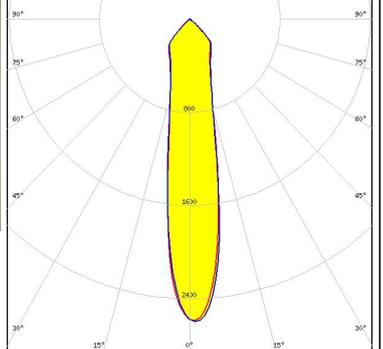
<p>LUMILEDS</p> <p>LED LUXEON CoB 1204/1205</p> <p>FWHM / FWTM 19.0° / 68.0°</p> <p>Efficiency 94 %</p> <p>Peak intensity 3.1 cd/m</p> <p>LEDs/each optic 1</p> <p>Light colour White</p> <p>Required components: TE Connectivity: 2213130-2 + OPTIC CLIP Z50 TYPE1 2213194-1</p>		
<p>LUMILEDS</p> <p>LED LUXEON CoB 1204HD</p> <p>FWHM / FWTM 15.0° / 53.0°</p> <p>Efficiency 95 %</p> <p>Peak intensity 3.7 cd/m</p> <p>LEDs/each optic 1</p> <p>Light colour White</p> <p>Required components: TE Connectivity: 2213382-2 + OPTIC CLIP Z50 TYPE1 2213194-1</p>		
<p>LUMILEDS</p> <p>LED LUXEON CoB 1205HD</p> <p>FWHM / FWTM 17.0° / 65.0°</p> <p>Efficiency 95 %</p> <p>Peak intensity 3.3 cd/m</p> <p>LEDs/each optic 1</p> <p>Light colour White</p> <p>Required components: TE Connectivity: 2213382-2 + OPTIC CLIP Z50 TYPE1 2213194-1</p>		
<p>LUMILEDS</p> <p>LED LUXEON CoB 1208</p> <p>FWHM / FWTM 20.0° / 84.0°</p> <p>Efficiency 94 %</p> <p>Peak intensity 2.6 cd/m</p> <p>LEDs/each optic 1</p> <p>Light colour White</p> <p>Required components: IDEAL: 50-2100SH + 50-2100AN</p>		

PHOTOMETRIC DATA (MEASURED):

LUMILEDS

LED LUXEON CoB 1208
 FWHM / FWTM 25.0° / 92.0°
 Efficiency 87 %
 Peak intensity 1.7 cd/lm
 LEDs/each optic 1
 Light colour White

Required components:

F13671_ANGE-RZ-LENS
 TE Connectivity: 2213130-2 + OPTIC CLIP Z50 TYPE1 2213194-1

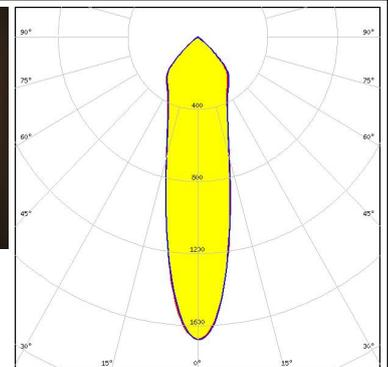

LUMILEDS

LED LUXEON CoB 1208
 FWHM / FWTM 23.0° / 89.0°
 Efficiency 88 %
 Peak intensity 1.9 cd/lm
 LEDs/each optic 1
 Light colour White

Required components:

F13671_ANGE-RZ-LENS
 IDEAL: 50-2100SH + 50-2100AN

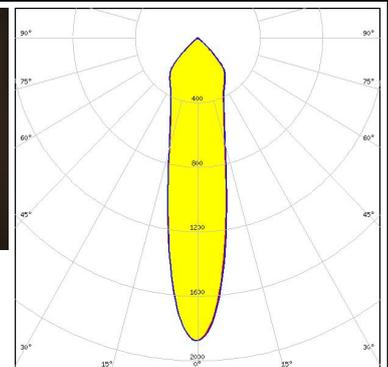

LUMILEDS

LED LUXEON CoB 1208
 FWHM / FWTM 21.0° / 79.0°
 Efficiency 93 %
 Peak intensity 2.7 cd/lm
 LEDs/each optic 1
 Light colour White

Required components:

TE Connectivity: 2213130-2 + OPTIC CLIP Z50 TYPE1 2213194-1

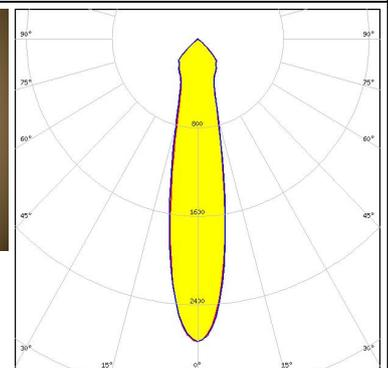

LUMILEDS

LED LUXEON CoB 1211
 FWHM / FWTM 30.0° / 93.0°
 Efficiency 87 %
 Peak intensity 1.4 cd/lm
 LEDs/each optic 1
 Light colour White

Required components:

F13671_ANGE-RZ-LENS
 IDEAL: 50-2204-CT + 50-2100AN

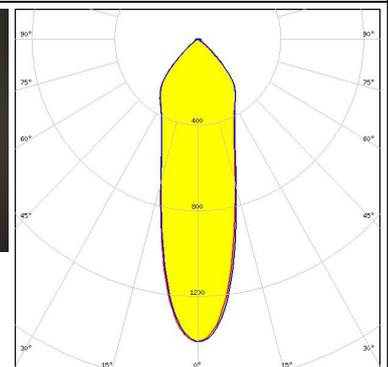
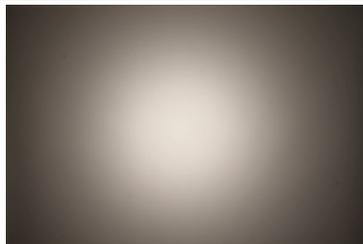

PHOTOMETRIC DATA (MEASURED):

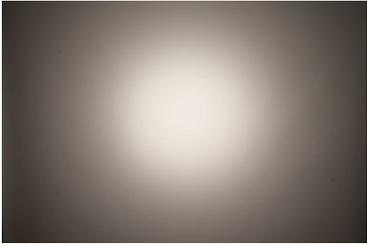
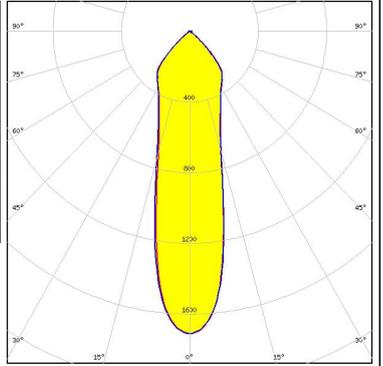
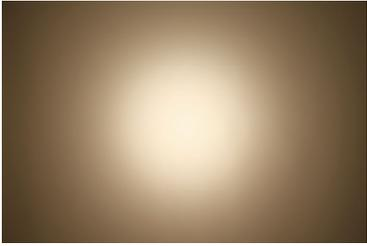
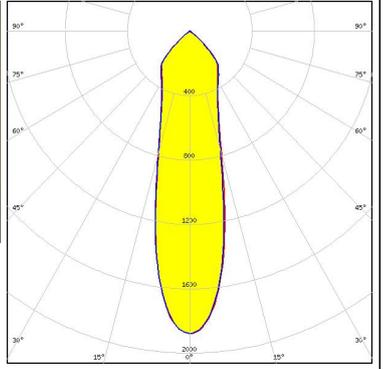
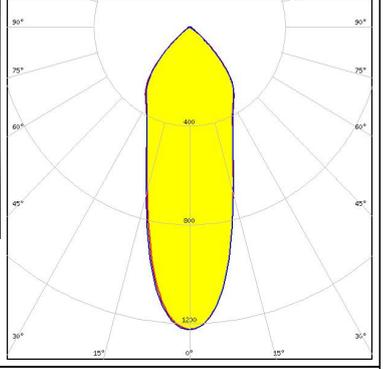
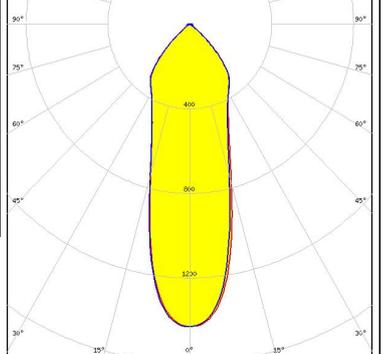
<p>LUMILEDS</p> <p>LED LUXEON CoB 1211</p> <p>FWHM / FWTM 26.0° / 91.0°</p> <p>Efficiency 91 %</p> <p>Peak intensity 1.7 cd/lm</p> <p>LEDs/each optic 1</p> <p>Light colour White</p> <p>Required components: IDEAL: 50-2204-CT + 50-2100AN</p>		
<p>LUMILEDS</p> <p>LED LUXEON CoB 1211</p> <p>FWHM / FWTM 26.0° / 91.0°</p> <p>Efficiency 94 %</p> <p>Peak intensity 1.9 cd/lm</p> <p>LEDs/each optic 1</p> <p>Light colour White</p> <p>Required components: C13584_CLAMP-VERO29 Bender Wirth: 431 Typ L3</p>		
<p>LUMILEDS</p> <p>LED LUXEON CoB 1216/1812</p> <p>FWHM / FWTM 34.0° / 95.0°</p> <p>Efficiency 87 %</p> <p>Peak intensity 1.2 cd/lm</p> <p>LEDs/each optic 1</p> <p>Light colour White</p> <p>Required components: F13671_ANGE-RZ-LENS IDEAL: 50-2204CT + 50-2100LN</p>		
<p>LUMILEDS</p> <p>LED LUXEON CoB 1216/1812</p> <p>FWHM / FWTM 31.0° / 93.0°</p> <p>Efficiency 91 %</p> <p>Peak intensity 1.4 cd/lm</p> <p>LEDs/each optic 1</p> <p>Light colour White</p> <p>Required components: IDEAL: 50-2204-CT + 50-2100AN</p>		

PHOTOMETRIC DATA (MEASURED):

LUMILEDS

LED LUXEON K12
FWHM / FWTM 25.0° / 93.0°
Efficiency 89 %
Peak intensity 1.8 cd/m
LEDs/each optic 1
Light colour White

Required components:

F13671_ANGE-RZ-LENS

TE Connectivity: 2213134-2 + OPTIC CLIP Z50 TYPE1 2213194-1

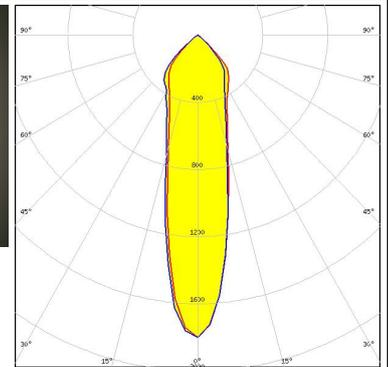

LUMILEDS

LED LUXEON K12
FWHM / FWTM 20.0° / 86.0°
Efficiency 94 %
Peak intensity 2.7 cd/m
LEDs/each optic 1
Light colour White

Required components:

TE Connectivity: 2213134-2 + OPTIC CLIP Z50 TYPE1 2213194-1

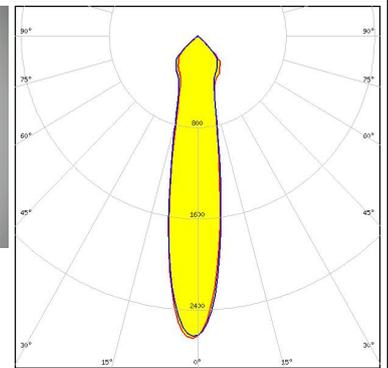

LUMILEDS

LED LUXEON K16
FWHM / FWTM 22.0° / 90.0°
Efficiency 94 %
Peak intensity 2.3 cd/m
LEDs/each optic 1
Light colour White

Required components:

TE Connectivity: 2213134-2 + OPTIC CLIP Z50 TYPE1 2213194-1

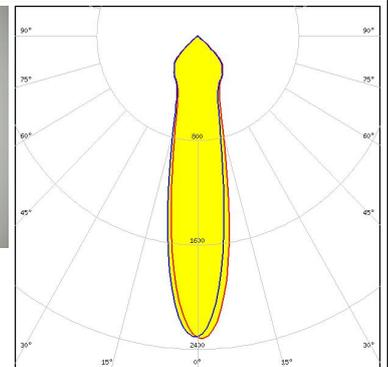

LUMILEDS

LED LUXEON K16
FWHM / FWTM 26.0° / 92.0°
Efficiency 89 %
Peak intensity 1.8 cd/m
LEDs/each optic 1
Light colour White

Required components:

F13671_ANGE-RZ-LENS

TE Connectivity: 2213134-2 + OPTIC CLIP Z50 TYPE1 2213194-1

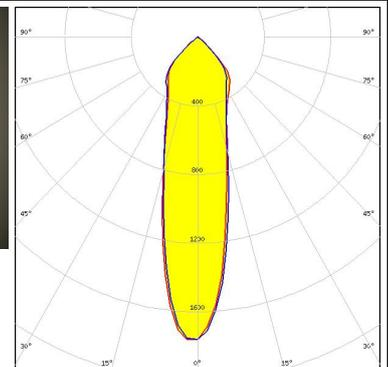

PHOTOMETRIC DATA (MEASURED):

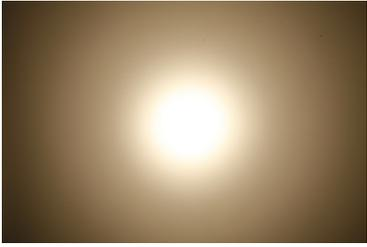
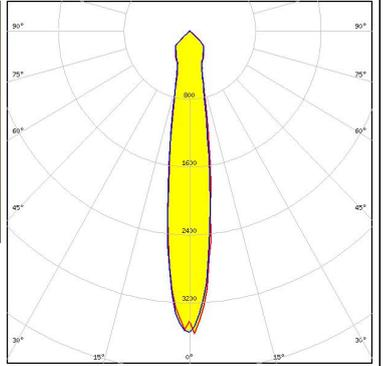
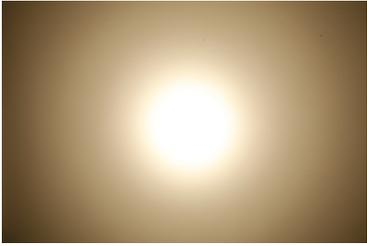
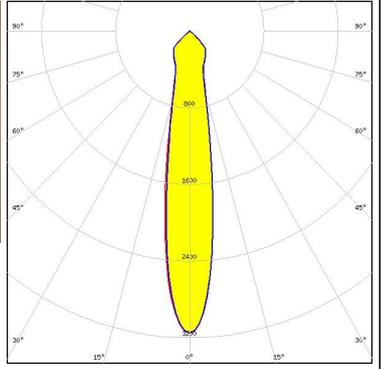
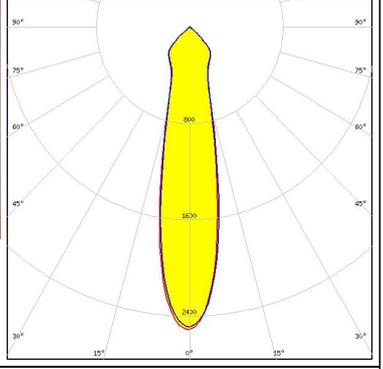
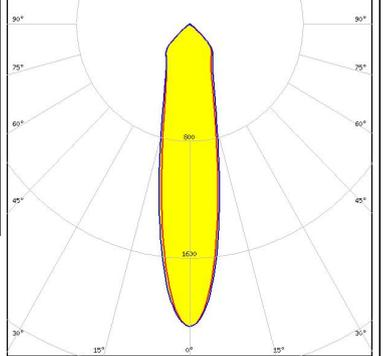
<p>LUMILEDS</p> <p>LED LUXEON S2000</p> <p>FWHM / FWTM 17.0° / 55.0°</p> <p>Efficiency 93 %</p> <p>Peak intensity 3.6 cd/m</p> <p>LEDs/each optic 1</p> <p>Light colour White</p> <p>Required components: C13395_CLAMP-S2000</p>		
<p>LUMILEDS</p> <p>LED LUXEON S3000</p> <p>FWHM / FWTM 18.0° / 65.0°</p> <p>Efficiency 92 %</p> <p>Peak intensity 3.2 cd/m</p> <p>LEDs/each optic 1</p> <p>Light colour White</p> <p>Required components: C13397_CLAMP-S3000</p>		
<p>LUMILEDS</p> <p>LED LUXEON S5000</p> <p>FWHM / FWTM 22.0° / 86.0°</p> <p>Efficiency 93 %</p> <p>Peak intensity 2.5 cd/m</p> <p>LEDs/each optic 1</p> <p>Light colour White</p> <p>Required components: C13399_CLAMP-S5000</p>		
<p>LUMINUS</p> <p>LED CDM-14 (Dim-To-Warm)</p> <p>FWHM / FWTM 23.0° / 89.0°</p> <p>Efficiency 89 %</p> <p>Peak intensity 2.1 cd/m</p> <p>LEDs/each optic 1</p> <p>Light colour White</p> <p>Required components: C13658_CLAMP-VERO13-18 F13671_ANGE-RZ-LENS Bender Wirth: 491 Typ L2</p>		

PHOTOMETRIC DATA (MEASURED):



LED CDM-14 (Dim-To-Warm)
 FWHM / FWTM 20.0° / 80.0°
 Efficiency 93 %
 Peak intensity 2.6 cd/m
 LEDs/each optic 1
 Light colour White
 Required components:
 C13658_CLAMP-VERO13-18
 Bender Wirth: 491 Typ L2

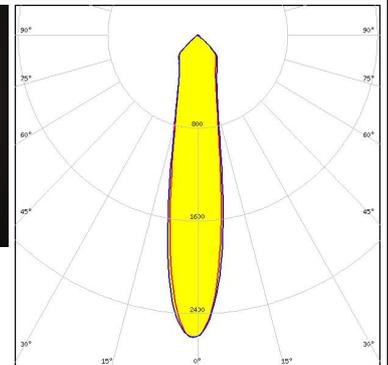

LED CDM-18 (Dim-To-Warm)
 FWHM / FWTM 26.0° / 91.0°
 Efficiency 89 %
 Peak intensity 1.8 cd/m
 LEDs/each optic 1
 Light colour White
 Required components:
 C13658_CLAMP-VERO13-18
 F13671_ANGE-RZ-LENS
 Bender Wirth: 491 Typ L2

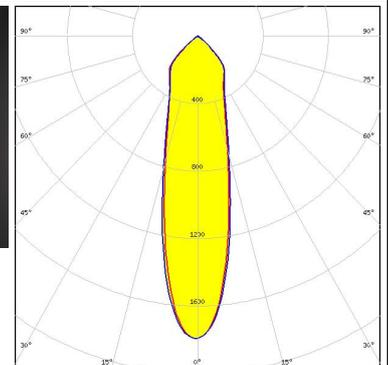
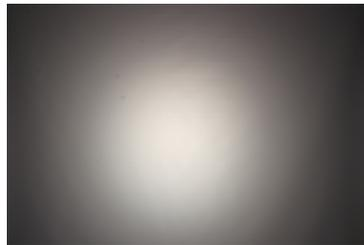

LED CDM-18 (Dim-To-Warm)
 FWHM / FWTM 24.0° / 89.0°
 Efficiency 93 %
 Peak intensity 2.2 cd/m
 LEDs/each optic 1
 Light colour White
 Required components:
 C13658_CLAMP-VERO13-18
 Bender Wirth: 491 Typ L2

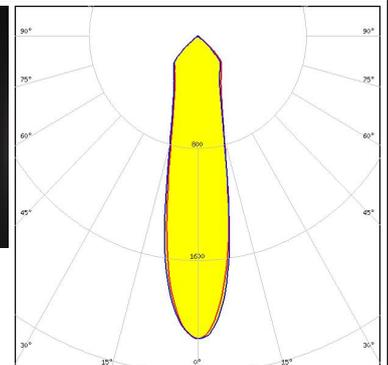
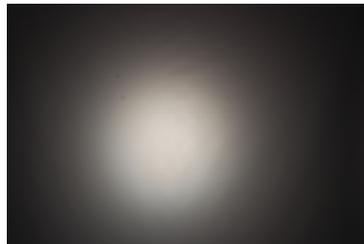

LED CDM-9 (Dim-To-Warm)
 FWHM / FWTM 21.0° / 91.0°
 Efficiency 87 %
 Peak intensity 2.1 cd/m
 LEDs/each optic 1
 Light colour White
 Required components:
 C13658_CLAMP-VERO13-18
 F13671_ANGE-RZ-LENS
 Bender Wirth: 490 Typ L1

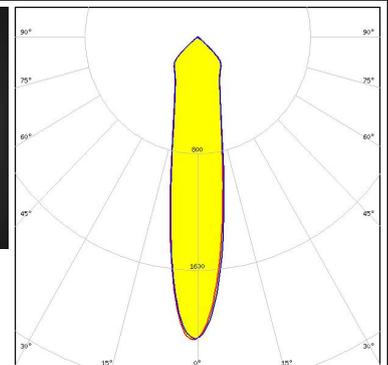
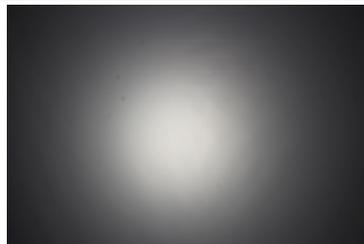

PHOTOMETRIC DATA (MEASURED):

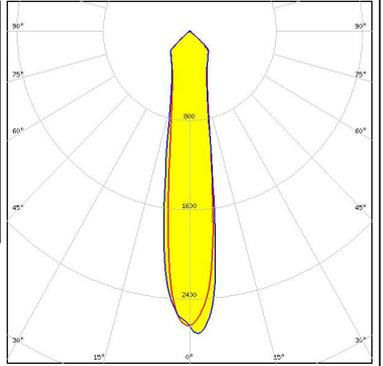
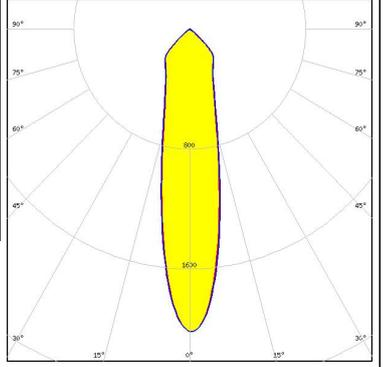
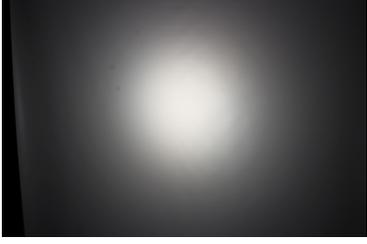
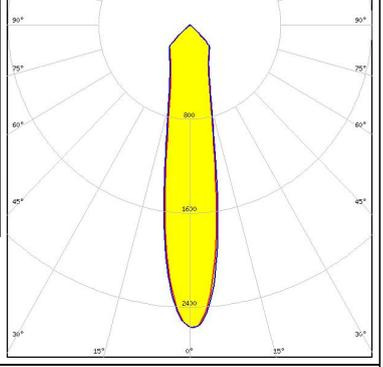
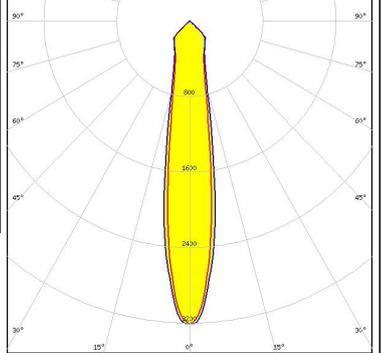
<p>LUMINUS</p> <p>LED CDM-9 (Dim-To-Warm)</p> <p>FWHM / FWTM 18.0° / 81.0°</p> <p>Efficiency 92 %</p> <p>Peak intensity 2.7 cd/m</p> <p>LEDs/each optic 1</p> <p>Light colour White</p> <p>Required components: C13658_CLAMP-VERO13-18 Bender Wirth: 490 Typ L1</p>		
<p>LUMINUS</p> <p>LED CTM-14 (Tunable White)</p> <p>FWHM / FWTM 23.0° / 90.0°</p> <p>Efficiency 88 %</p> <p>Peak intensity 2 cd/m</p> <p>LEDs/each optic 1</p> <p>Light colour White</p> <p>Required components: C13584_CLAMP-VERO29 F13671_ANGE-RZ-LENS Bender Wirth: 442 Typ L3</p>		
<p>LUMINUS</p> <p>LED CTM-14 (Tunable White)</p> <p>FWHM / FWTM 20.0° / 86.0°</p> <p>Efficiency 93 %</p> <p>Peak intensity 2.6 cd/m</p> <p>LEDs/each optic 1</p> <p>Light colour White</p> <p>Required components: C13584_CLAMP-VERO29 Bender Wirth: 442 Typ L3</p>		
<p>LUMINUS</p> <p>LED CTM-14 RGBW</p> <p>FWHM / FWTM 18.0° / 62.0°</p> <p>Efficiency 94 %</p> <p>Peak intensity 3.2 cd/m</p> <p>LEDs/each optic 1</p> <p>Light colour RGBW</p> <p>Required components: C13584_CLAMP-VERO29 Bender Wirth: 500 Typ L3-1</p>		

PHOTOMETRIC DATA (MEASURED):



LED CTM-14 RGBW
FWHM / FWTM 22.0° / 87.0°
Efficiency 90 %
Peak intensity 2.2 cd/lm
LEDs/each optic 1
Light colour RGBW
Required components:
 C13584_CLAMP-VERO29
 F13671_ANGE-RZ-LENS
 Bender Wirth: 500 Typ L3-1

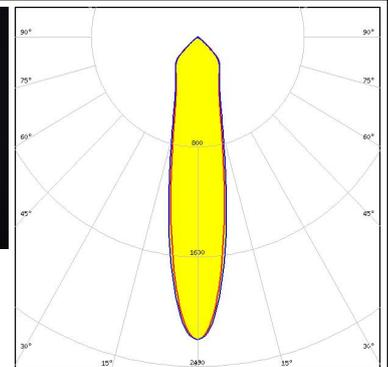

LED CTM-22 (Tunable White)
FWHM / FWTM 32.0° / 95.0°
Efficiency 87 %
Peak intensity 1.4 cd/lm
LEDs/each optic 1
Light colour White
Required components:
 C13584_CLAMP-VERO29
 F13671_ANGE-RZ-LENS
 Bender Wirth: 494 Typ L3

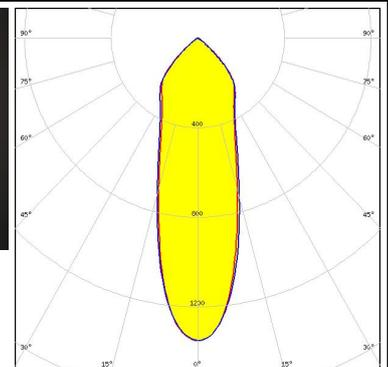

LED CTM-22 (Tunable White)
FWHM / FWTM 29.0°
Efficiency 91 %
Peak intensity 1.6 cd/lm
LEDs/each optic 1
Light colour White
Required components:
 C13584_CLAMP-VERO29
 Bender Wirth: 494 Typ L3

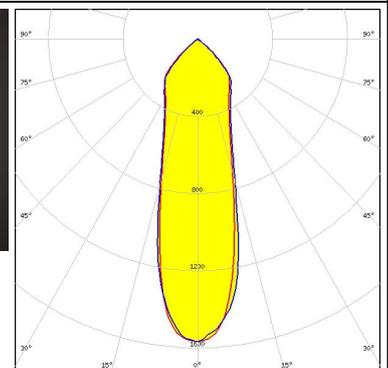
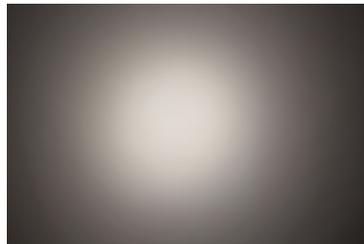

LED CxM-14 (19x19)
FWHM / FWTM 20.0° / 86.0°
Efficiency 94 %
Peak intensity 2.5 cd/lm
LEDs/each optic 1
Light colour White
Required components:
 TE Connectivity: 2213254-2 + OPTIC CLIP Z50 TYPE1 2213194-1

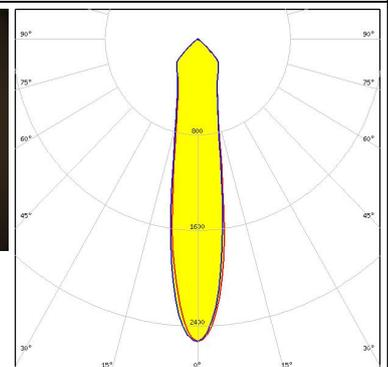

PHOTOMETRIC DATA (MEASURED):

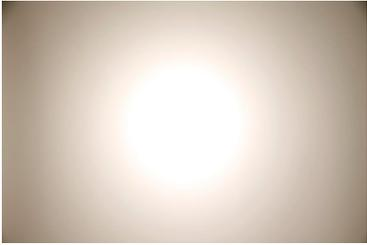
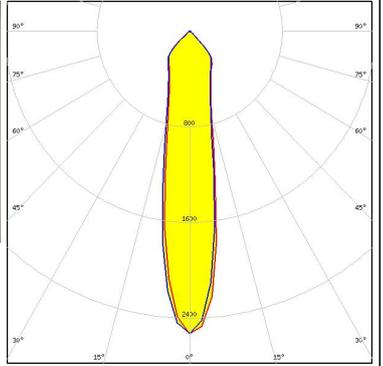
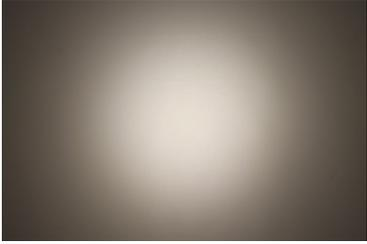
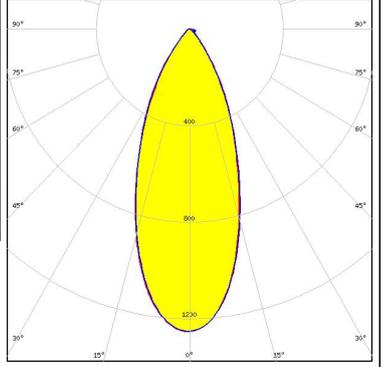
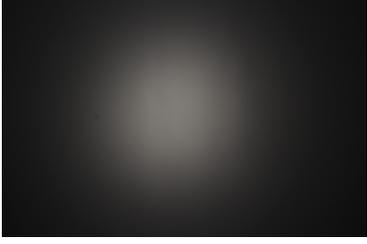
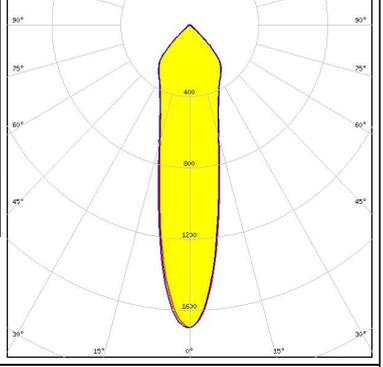
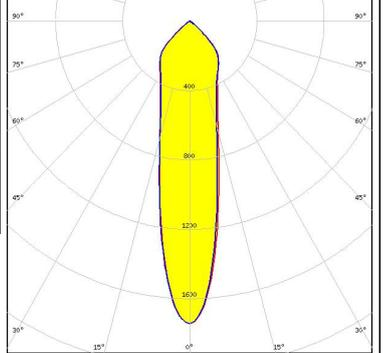
<p>NICHIA</p> <p>LED COB J-Type FWHM / FWTM 20.0° / 85.0° Efficiency 94 % Peak intensity 2.5 cd/m LEDs/each optic 1 Light colour White Required components: IDEAL: 50-2103NC + 50-2100AN</p>		
<p>NICHIA</p> <p>LED COB J-Type FWHM / FWTM 22.0° / 89.0° Efficiency 93 % Peak intensity 2.3 cd/m LEDs/each optic 1 Light colour White Required components: C13658_CLAMP-VERO13-18 Bender Wirth: 463 Typ L2</p>		
<p>NICHIA</p> <p>LED COB J-Type FWHM / FWTM 24.0° / 90.0° Efficiency 87 % Peak intensity 1.7 cd/m LEDs/each optic 1 Light colour White Required components: F13671_ANGE-RZ-LENS IDEAL: 50-2103NC + 50-2100AN</p>		
<p>NICHIA</p> <p>LED COB L-Type (LES 11) FWHM / FWTM 23.0° / 92.0° Efficiency 86 % Peak intensity 1.7 cd/m LEDs/each optic 1 Light colour White Required components: F13671_ANGE-RZ-LENS TE Connectivity: 2213382-2 + OPTIC CLIP Z50 TYPE1 2213194-1</p>		

PHOTOMETRIC DATA (MEASURED):

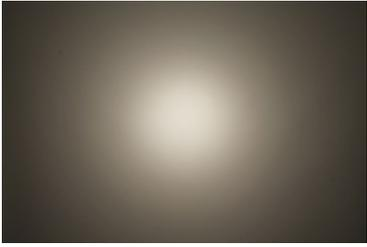
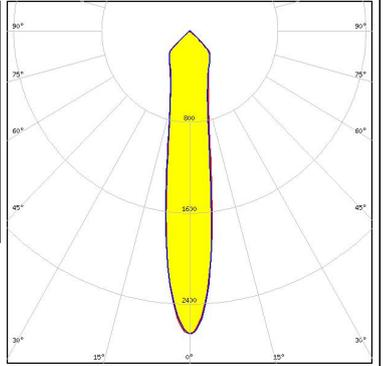
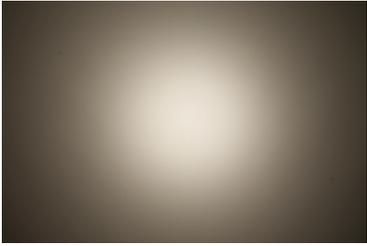
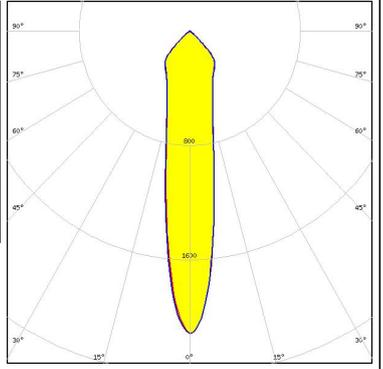
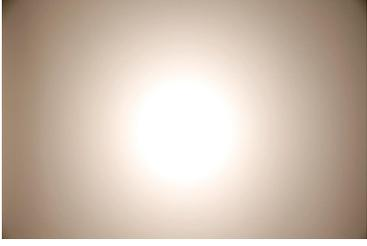
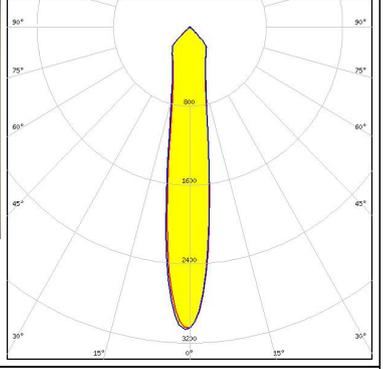
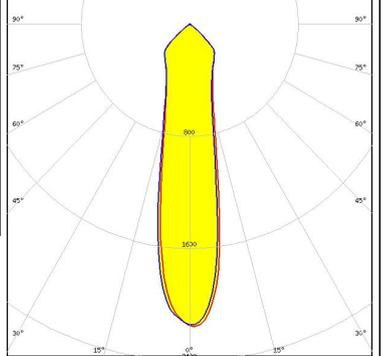
<p>NICHIA</p> <p>LED COB L-Type (LES 11)</p> <p>FWHM / FWTM 17.0° / 86.0°</p> <p>Efficiency 92 %</p> <p>Peak intensity 2.7 cd/m</p> <p>LEDs/each optic 1</p> <p>Light colour White</p> <p>Required components: TE Connectivity: 2213382-2 + OPTIC CLIP Z50 TYPE1 2213194-1</p>		
<p>NICHIA</p> <p>LED COB L-Type (LES 11)</p> <p>FWHM / FWTM 19.0° / 88.0°</p> <p>Efficiency 87 %</p> <p>Peak intensity 2.1 cd/m</p> <p>LEDs/each optic 1</p> <p>Light colour White</p> <p>Required components: F13671_ANGE-RZ-LENS IDEAL: 50-2100NC + 50-2100AN</p>		
<p>NICHIA</p> <p>LED COB L-Type (LES 11)</p> <p>FWHM / FWTM 16.0° / 71.0°</p> <p>Efficiency 91 %</p> <p>Peak intensity 3.1 cd/m</p> <p>LEDs/each optic 1</p> <p>Light colour White</p> <p>Required components: IDEAL: 50-2100NC + 50-2100AN</p>		
<p>NICHIA</p> <p>LED COB L-Type (LES 11)</p> <p>FWHM / FWTM 22.0° / 93.0°</p> <p>Efficiency 94 %</p> <p>Peak intensity 2.2 cd/m</p> <p>LEDs/each optic 1</p> <p>Light colour White</p> <p>Required components: Molex: 180580-0005</p>		

PHOTOMETRIC DATA (MEASURED):

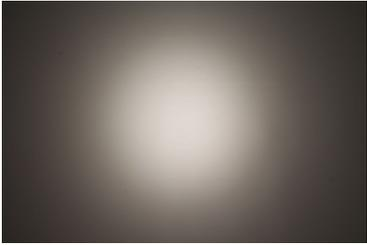
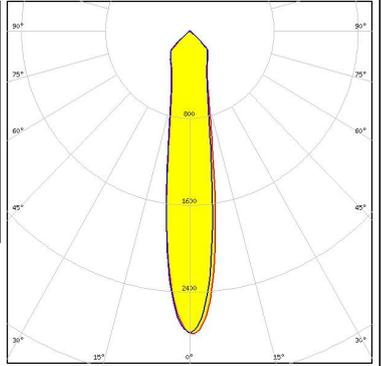
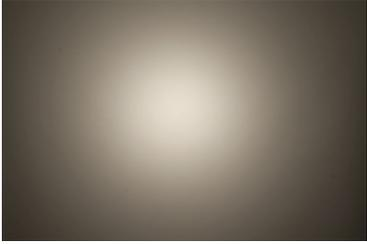
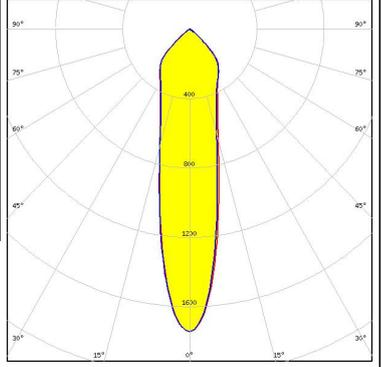
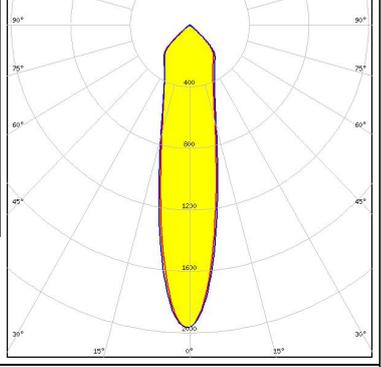
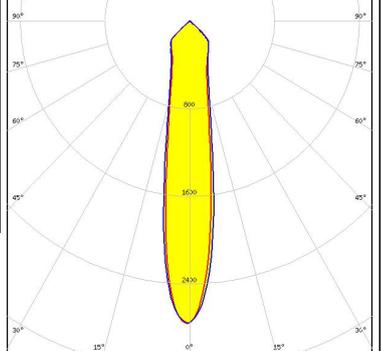
<p>NICHIA</p> <p>LED COB L-Type (LES 11)</p> <p>FWHM / FWTM 18.0° / 78.0°</p> <p>Efficiency 93 %</p> <p>Peak intensity 2.8 cd/lm</p> <p>LEDs/each optic 1</p> <p>Light colour White</p> <p>Required components: C13658_CLAMP-VERO13-18 Bender Wirth: 438 Typ L1</p>		
<p>NICHIA</p> <p>LED COB L-Type (LES 11)</p> <p>FWHM / FWTM 17.0° / 86.0°</p> <p>Efficiency 92 %</p> <p>Peak intensity 2.7 cd/lm</p> <p>LEDs/each optic 1</p> <p>Light colour White</p> <p>Required components: TE Connectivity: 2213382-2 + OPTIC CLIP Z50 TYPE1 2213194-1</p>		
<p>NICHIA</p> <p>LED NVCWJ024Z-V1MT: COB J-Type Tunable White</p> <p>FWHM / FWTM 22.0° / 91.0°</p> <p>Efficiency 88 %</p> <p>Peak intensity 2 cd/lm</p> <p>LEDs/each optic 1</p> <p>Light colour White</p> <p>Required components: C13658_CLAMP-VERO13-18 F13671_ANGE-RZ-LENS Bender Wirth: 498 Typ L2</p>		
<p>NICHIA</p> <p>LED NVCWJ024Z-V1MT: COB J-Type Tunable White</p> <p>FWHM / FWTM 18.0° / 80.0°</p> <p>Efficiency 93 %</p> <p>Peak intensity 2.8 cd/lm</p> <p>LEDs/each optic 1</p> <p>Light colour White</p> <p>Required components: C13658_CLAMP-VERO13-18 Bender Wirth: 498 Typ L2</p>		

PHOTOMETRIC DATA (MEASURED):

OSRAM

LED PrevaLED Core AC (LEP-2000)
 FWHM / FWTM 23.0° / 88.0°
 Efficiency 93 %
 Peak intensity 2.1 cd/m
 LEDs/each optic 1
 Light colour White
 Required components:
 TE Connectivity: OPTIC CLIP Z50 TYPE1 2213194-1

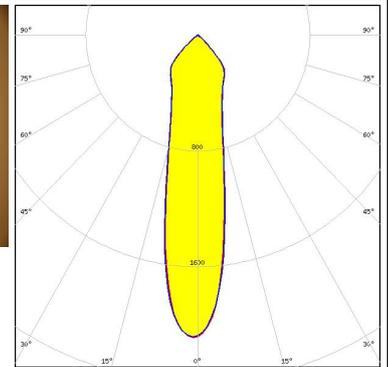
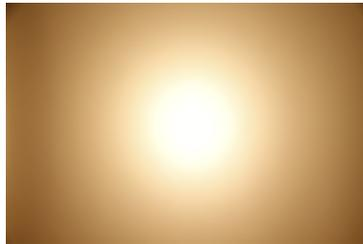

OSRAM

LED PrevaLED Core AC (LEP-800)
 FWHM / FWTM 16.0° / 76.0°
 Efficiency 94 %
 Peak intensity 3.1 cd/m
 LEDs/each optic 1
 Light colour White
 Required components:
 TE Connectivity: OPTIC CLIP Z50 TYPE1 2213194-1

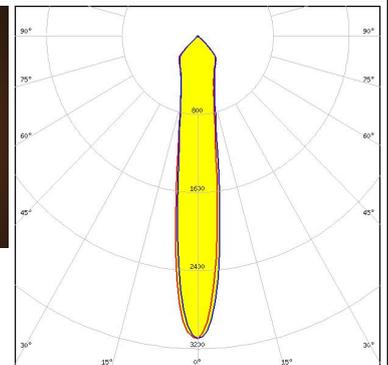

OSRAM

LED PrevaLED Core G7 L15 H1
 FWHM / FWTM 24.0° / 90.0°
 Efficiency 91 %
 Peak intensity 1.9 cd/m
 LEDs/each optic 1
 Light colour White
 Required components:
 C16685_CLAMP-PRV-A
 F13671_ANGE-RZ-LENS

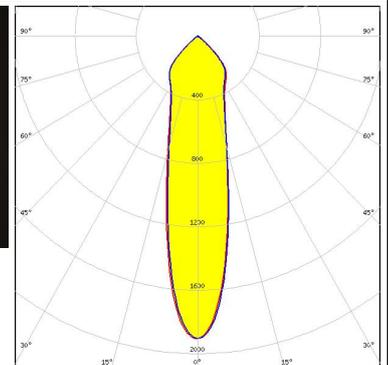

OSRAM

LED PrevaLED Core G7 L15 H1
 FWHM / FWTM 21.0° / 88.0°
 Efficiency 94 %
 Peak intensity 2.4 cd/m
 LEDs/each optic 1
 Light colour White
 Required components:
 C16685_CLAMP-PRV-A

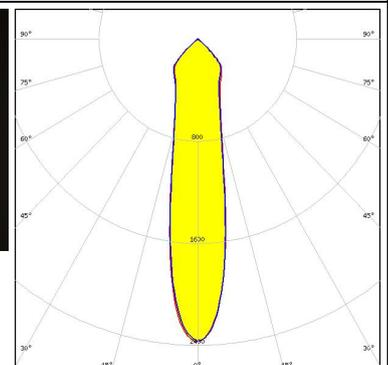

PHOTOMETRIC DATA (MEASURED):

OSRAM

LED PrevaLED Core Z3 LES19
 FWHM / FWTM 23.0° / 89.0°
 Efficiency 94 %
 Peak intensity 2.2 cd/lm
 LEDs/each optic 1
 Light colour White
 Required components:
 TE Connectivity: OPTIC CLIP Z50 TYPE1 2213194-1

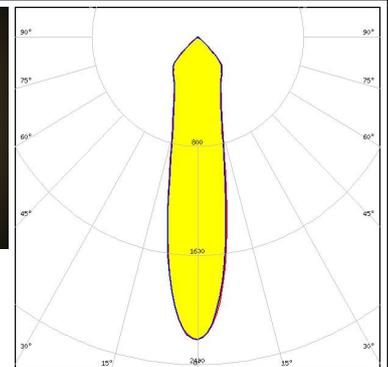

OSRAM

LED PrevaLED Core Z3 LES23
 FWHM / FWTM 27.0° / 91.0°
 Efficiency 94 %
 Peak intensity 1.8 cd/lm
 LEDs/each optic 1
 Light colour White
 Required components:
 TE Connectivity: OPTIC CLIP Z50 TYPE1 2213194-1

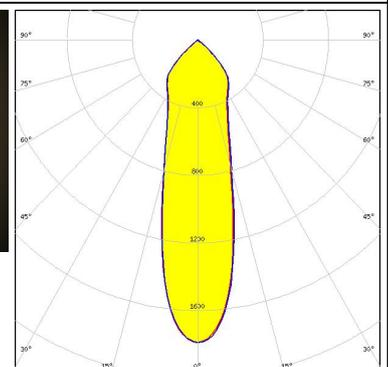

OSRAM

LED PrevaLED Core Z3 LES9
 FWHM / FWTM 14.0° / 54.0°
 Efficiency 94 %
 Peak intensity 3.8 cd/lm
 LEDs/each optic 1
 Light colour White
 Required components:
 TE Connectivity: OPTIC CLIP Z50 TYPE1 2213194-1

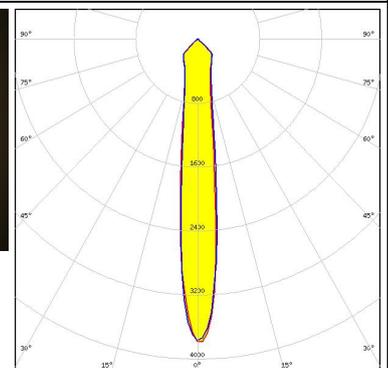

OSRAM

LED PrevaLED Core Z4 LES19
 FWHM / FWTM 21.0° / 87.0°
 Efficiency 94 %
 Peak intensity 2.3 cd/lm
 LEDs/each optic 1
 Light colour White
 Required components:
 TE Connectivity: OPTIC CLIP Z50 TYPE1 2213194-1

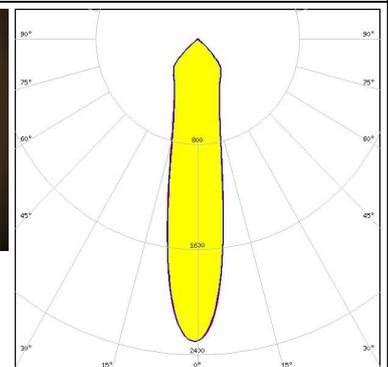

PHOTOMETRIC DATA (MEASURED):

OSRAM

LED PrevaLED Core Z4 LES19
 FWHM / FWTM 26.0° / 92.0°
 Efficiency 88 %
 Peak intensity 1.6 cd/lm
 LEDs/each optic 1
 Light colour White
 Required components:
 F13671_ANGE-RZ-LENS
 TE Connectivity: OPTIC CLIP Z50 TYPE1 2213194-1

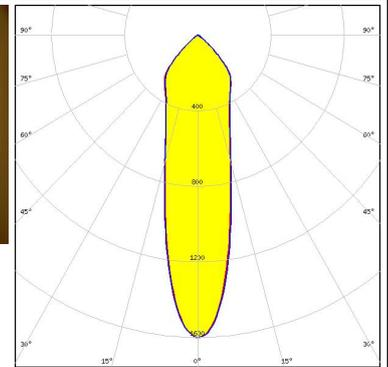

OSRAM Opto Semiconductors

LED Soleriq S13
 FWHM / FWTM 20.0° / 82.0°
 Efficiency 94 %
 Peak intensity 2.8 cd/lm
 LEDs/each optic 1
 Light colour White
 Required components:
 TE Connectivity: 2213401-2 + OPTIC CLIP Z50 TYPE1 2213194-1

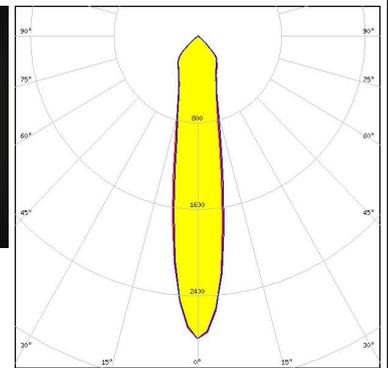

OSRAM Opto Semiconductors

LED Soleriq S13
 FWHM / FWTM 20.0° / 89.0°
 Efficiency 92 %
 Peak intensity 2.4 cd/lm
 LEDs/each optic 1
 Light colour White
 Required components:
 C13658_CLAMP-VERO13-18
 Bender Wirth: 437 Typ L1

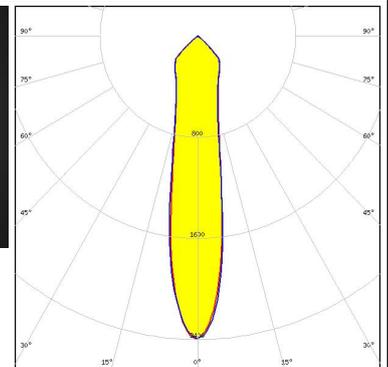
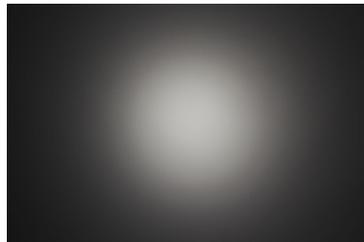

OSRAM Opto Semiconductors

LED Soleriq S13 19x19
 FWHM / FWTM 22.0° / 90.0°
 Efficiency 87 %
 Peak intensity 1.9 cd/lm
 LEDs/each optic 1
 Light colour White
 Required components:
 F13671_ANGE-RZ-LENS
 IDEAL: 50-2103CT + 50-2100AN

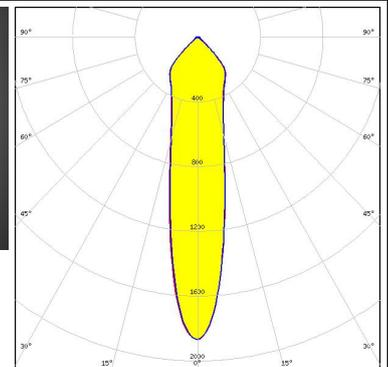
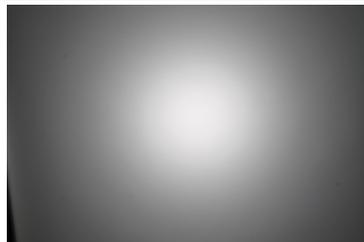

PHOTOMETRIC DATA (MEASURED):

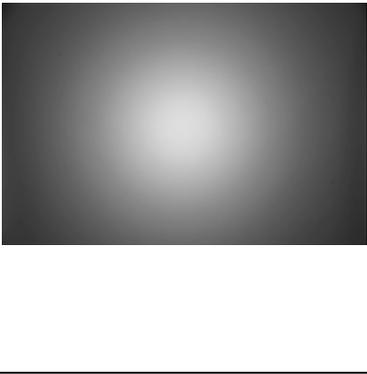
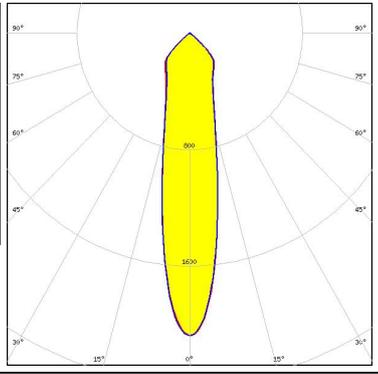
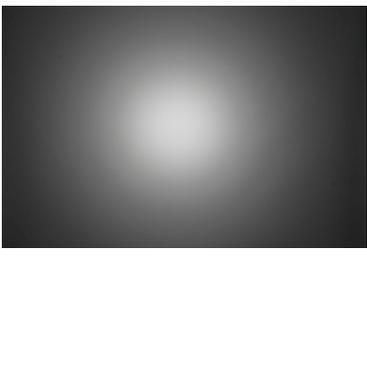
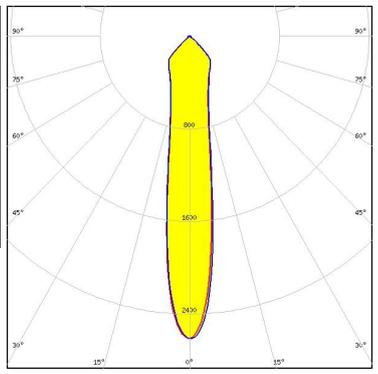
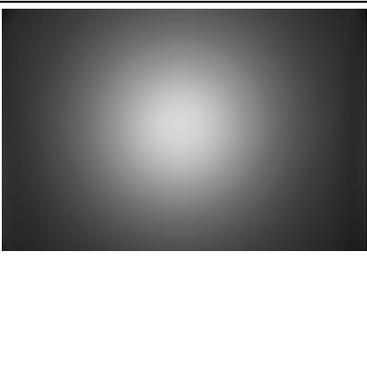
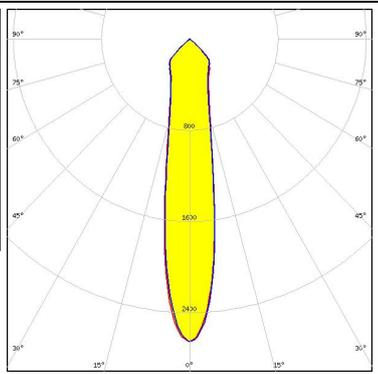
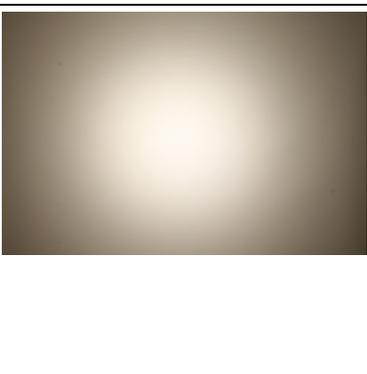
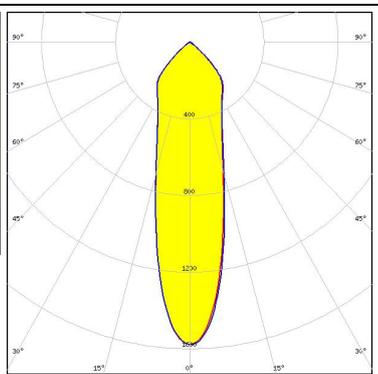
<p>OSRAM Opto Semiconductors</p> <p>LED Soleriq S13 19x19</p> <p>FWHM / FWTM 22.0° / 90.0°</p> <p>Efficiency 88 %</p> <p>Peak intensity 2.1 cd/m</p> <p>LEDs/each optic 1</p> <p>Light colour White</p> <p>Required components: F13671_ANGE-RZ-LENS TE Connectivity: 2213254-2 + OPTIC CLIP Z50 TYPE1 2213194-1</p>		
<p>OSRAM Opto Semiconductors</p> <p>LED Soleriq S13 19x19</p> <p>FWHM / FWTM 17.0° / 86.0°</p> <p>Efficiency 91 %</p> <p>Peak intensity 2.6 cd/m</p> <p>LEDs/each optic 1</p> <p>Light colour White</p> <p>Required components: IDEAL: 50-2103CT + 50-2100AN</p>		
<p>OSRAM Opto Semiconductors</p> <p>LED Soleriq S13 19x19</p> <p>FWHM / FWTM 19.0° / 84.0°</p> <p>Efficiency 93 %</p> <p>Peak intensity 2.7 cd/m</p> <p>LEDs/each optic 1</p> <p>Light colour White</p> <p>Required components: TE Connectivity: 2213254-2 + OPTIC CLIP Z50 TYPE1 2213194-1</p>		
<p>OSRAM Opto Semiconductors</p> <p>LED Soleriq S19</p> <p>FWHM / FWTM 27.0° / 93.0°</p> <p>Efficiency 88 %</p> <p>Peak intensity 1.6 cd/m</p> <p>LEDs/each optic 1</p> <p>Light colour White</p> <p>Required components: F13671_ANGE-RZ-LENS TE Connectivity: 2213407-2 + OPTIC CLIP Z50 TYPE1 2213194-1</p>		

PHOTOMETRIC DATA (MEASURED):

OSRAM

Opto Semiconductors

LED Soleriq S19
 FWHM / FWTM 22.0° / 87.0°
 Efficiency 94 %
 Peak intensity 2.4 cd/m
 LEDs/each optic 1
 Light colour White

Required components:

TE Connectivity: 2213407-2 + OPTIC CLIP Z50 TYPE1 2213194-1

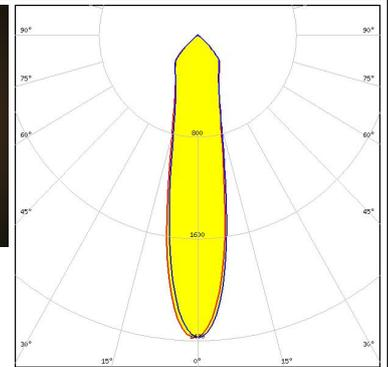

OSRAM

Opto Semiconductors

LED Soleriq S19
 FWHM / FWTM 23.0° / 89.0°
 Efficiency 92 %
 Peak intensity 2.1 cd/m
 LEDs/each optic 1
 Light colour White

Required components:

C13584_CLAMP-VERO29

Bender Wirth: 462 Typ L3

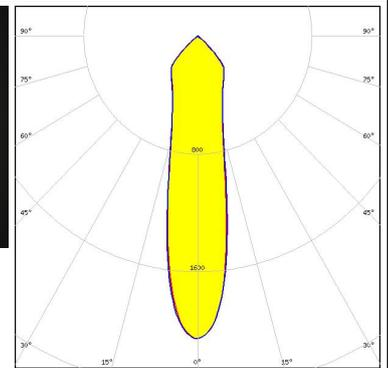

PHILIPS

LED Fortimo SLM L09 + SLM holder
 FWHM / FWTM 15.0° / 70.0°
 Efficiency 92 %
 Peak intensity 3.2 cd/m
 LEDs/each optic 1
 Light colour White

Required components:

TE Connectivity: OPTIC CLIP Z50 TYPE1 2213194-1

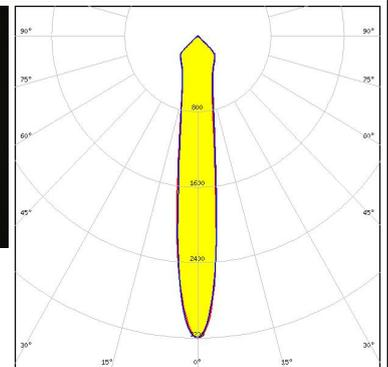

PHILIPS

LED Fortimo SLM L13 + SLM holder
 FWHM / FWTM 19.0° / 86.0°
 Efficiency 92 %
 Peak intensity 2.6 cd/m
 LEDs/each optic 1
 Light colour White

Required components:

TE Connectivity: OPTIC CLIP Z50 TYPE1 2213194-1

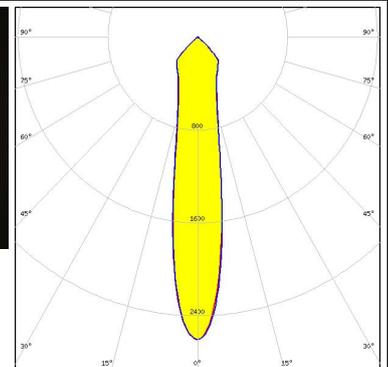

PHOTOMETRIC DATA (MEASURED):

PHILIPS

LED Fortimo SLM L13 CoB
 FWHM / FWTM 20.0° / 78.0°
 Efficiency 94 %
 Peak intensity 2.8 cd/lm
 LEDs/each optic 1
 Light colour White

Required components:

TE Connectivity: 2213130-2 + OPTIC CLIP Z50 TYPE1 2213194-1



PHILIPS

LED Fortimo SLM L13 CoB
 FWHM / FWTM 23.0° / 89.0°
 Efficiency 88 %
 Peak intensity 2 cd/lm
 LEDs/each optic 1
 Light colour White

Required components:

F13671_ANGE-RZ-LENS
 TE Connectivity: 2213130-2 + OPTIC CLIP Z50 TYPE1 2213194-1



PHILIPS

LED Fortimo SLM L15 + SLM holder
 FWHM / FWTM 21.0° / 88.0°
 Efficiency 91 %
 Peak intensity 2.2 cd/lm
 LEDs/each optic 1
 Light colour White

Required components:

TE Connectivity: OPTIC CLIP Z50 TYPE1 2213194-1

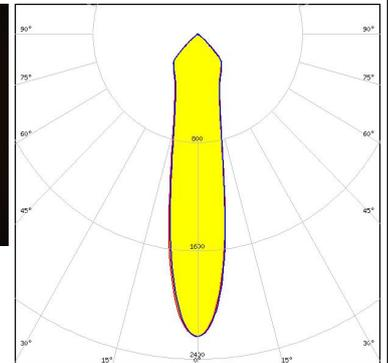

PHILIPS

LED Fortimo SLM L15 + SLM holder
 FWHM / FWTM 27.0° / 93.0°
 Efficiency 87 %
 Peak intensity 1.6 cd/lm
 LEDs/each optic 1
 Light colour White

Required components:

F13671_ANGE-RZ-LENS
 TE Connectivity: OPTIC CLIP Z50 TYPE1 2213194-1

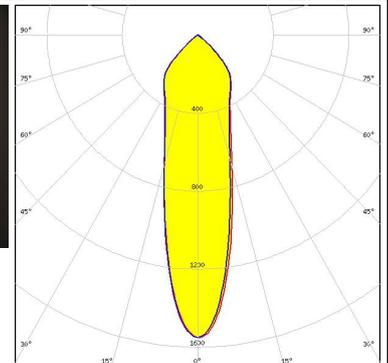

PHOTOMETRIC DATA (MEASURED):

PHILIPS

LED Fortimo SLM L15 CoB
 FWHM / FWTM 22.0° / 86.0°
 Efficiency 94 %
 Peak intensity 2.5 cd/lm
 LEDs/each optic 1
 Light colour White
 Required components:
 TE Connectivity: 2213130-2 + OPTIC CLIP Z50 TYPE1 2213194-1

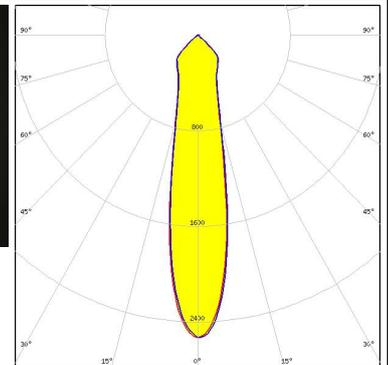

PHILIPS

LED Fortimo SLM L15 CoB
 FWHM / FWTM 24.0° / 90.0°
 Efficiency 88 %
 Peak intensity 2 cd/lm
 LEDs/each optic 1
 Light colour White
 Required components:
 F13671_ANGE-RZ-LENS
 TE Connectivity: 2213130-2 + OPTIC CLIP Z50 TYPE1 2213194-1

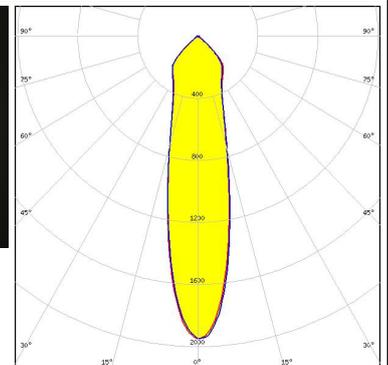

PHILIPS

LED Fortimo SLM L19 + SLM holder
 FWHM / FWTM 26.0° / 91.0°
 Efficiency 90 %
 Peak intensity 1.8 cd/lm
 LEDs/each optic 1
 Light colour White
 Required components:
 TE Connectivity: OPTIC CLIP Z50 TYPE1 2213194-1

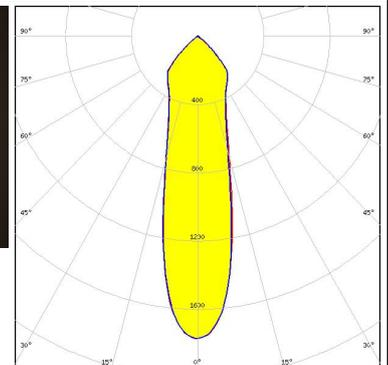

SAMSUNG

LED LC026B / 033B / 040B
 FWHM / FWTM 25.0° / 92.0°
 Efficiency 92 %
 Peak intensity 1.8 cd/lm
 LEDs/each optic 1
 Light colour White
 Required components:
 C13658_CLAMP-VERO13-18
 Bender Wirth: 450 Typ L2

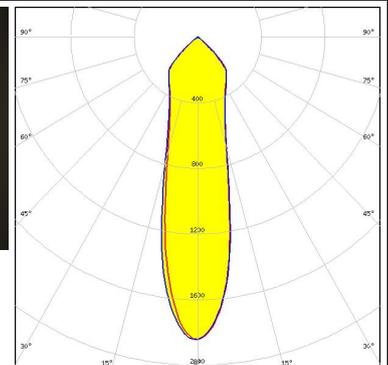

PHOTOMETRIC DATA (MEASURED):

SAMSUNG

LED LC026B / 033B / 040B
 FWHM / FWTM 24.0° / 89.0°
 Efficiency 93 %
 Peak intensity 2.1 cd/m
 LEDs/each optic 1
 Light colour White

Required components:

TE Connectivity: 2213258-2 + OPTIC CLIP Z50 TYPE1 2213194-1

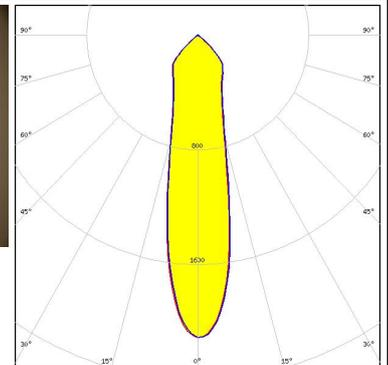
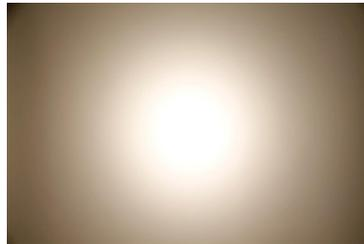

SAMSUNG

LED LC035T (Tunable white)
 FWHM / FWTM 34.0° / 95.0°
 Efficiency 89 %
 Peak intensity 1.3 cd/m
 LEDs/each optic 1
 Light colour Tunable White

Required components:

C13584_CLAMP-VERO29

F13671_ANGE-RZ-LENS

Bender Wirth: 502 Typ L3

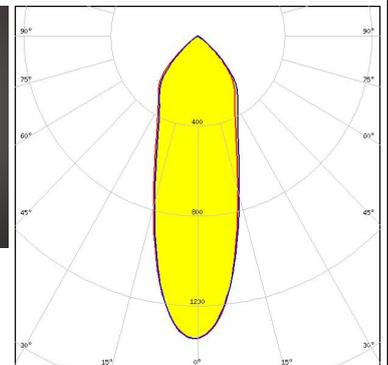

SAMSUNG

LED LC035T (Tunable white)
 FWHM / FWTM 31.0° / 93.0°
 Efficiency 94 %
 Peak intensity 1.6 cd/m
 LEDs/each optic 1
 Light colour Tunable White

Required components:

C13584_CLAMP-VERO29

Bender Wirth: 502 Typ L3

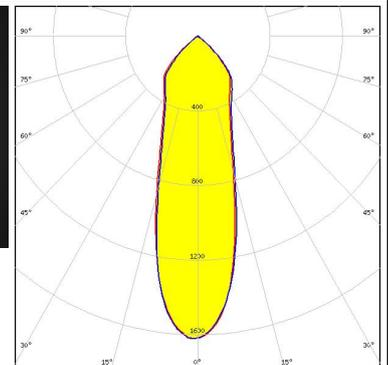
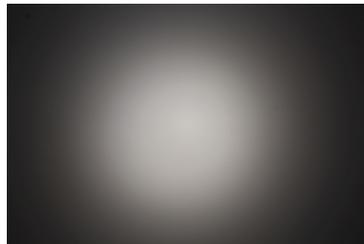

SAMSUNG

LED LC040C
 FWHM / FWTM 21.0° / 89.0°
 Efficiency 89 %
 Peak intensity 2.2 cd/m
 LEDs/each optic 1
 Light colour White

Required components:

F13671_ANGE-RZ-LENS

TE Connectivity: 2213382-2 + OPTIC CLIP Z50 TYPE1 2213194-1

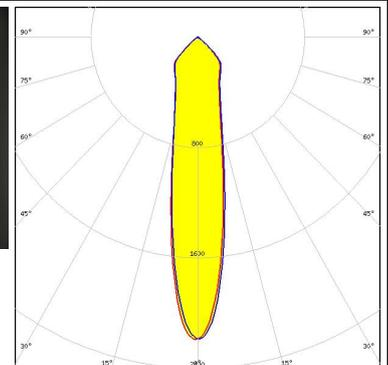
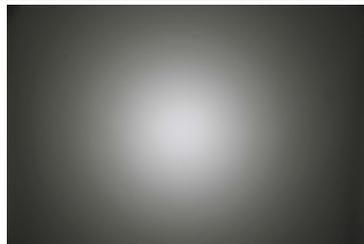

PHOTOMETRIC DATA (MEASURED):

SAMSUNG

LED LC040C
 FWHM / FWTM 18.0° / 87.0°
 Efficiency 92 %
 Peak intensity 2.6 cd/lm
 LEDs/each optic 1
 Light colour White
 Required components:
 TE Connectivity: 2213382-2 + OPTIC CLIP Z50 TYPE1 2213194-1

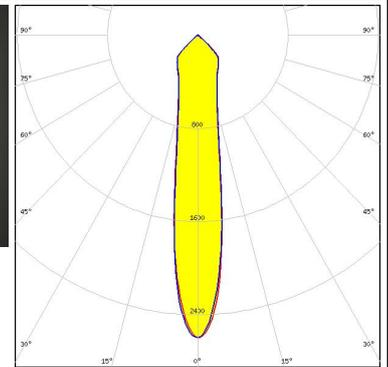
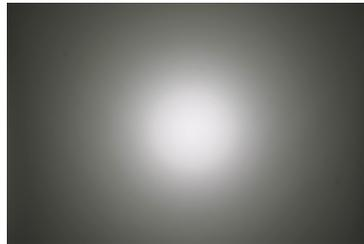

SEOL
 SEOUL SEMICONDUCTOR
 LED AC Zhaga COB
 FWHM / FWTM 30.0° / 96.0°
 Efficiency 88 %
 Peak intensity 1.4 cd/lm
 LEDs/each optic 1
 Light colour White
 Required components:
 F13671_ANGE-RZ-LENS
 Optosource: SEHSMJD-A

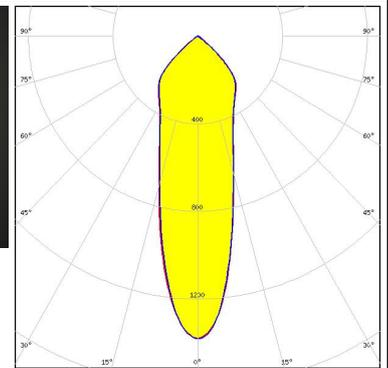

SEOL
 SEOUL SEMICONDUCTOR
 LED MJT COB LES 14.5
 FWHM / FWTM 22.0° / 89.0°
 Efficiency 93 %
 Peak intensity 2.2 cd/lm
 LEDs/each optic 1
 Light colour White
 Required components:
 TE Connectivity: 2213254-2 + OPTIC CLIP Z50 TYPE1 2213194-1

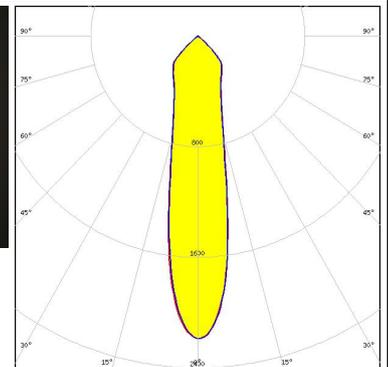

SEOL
 SEOUL SEMICONDUCTOR
 LED MJT COB LES 22
 FWHM / FWTM 30.0° / 93.0°
 Efficiency 91 %
 Peak intensity 1.5 cd/lm
 LEDs/each optic 1
 Light colour White
 Required components:
 C13584_CLAMP-VERO29
 Bender Wirth: 431 Typ L3

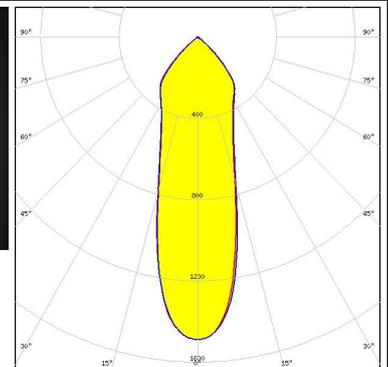

PHOTOMETRIC DATA (MEASURED):

SHARP

LED Mega Zenigata (GW6DME)
 FWHM / FWTM 21.0° / 75.0°
 Efficiency 92 %
 Peak intensity 2.8 cd/lm
 LEDs/each optic 1
 Light colour White

Required components:

TE Connectivity: 2213130-2 + OPTIC CLIP Z50 TYPE1 2213194-1

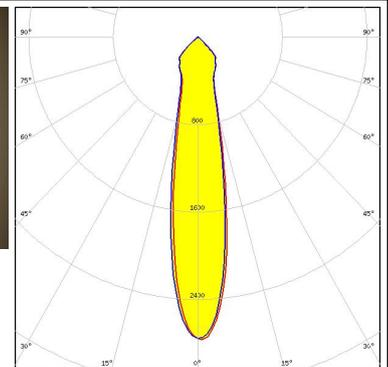
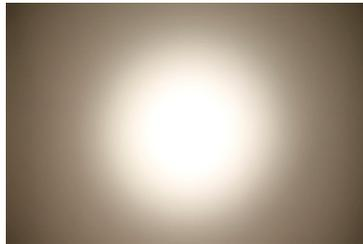

SHARP

LED Mega Zenigata (GW6DME)
 FWHM / FWTM 24.0° / 91.0°
 Efficiency 89 %
 Peak intensity 1.9 cd/lm
 LEDs/each optic 1
 Light colour White

Required components:

F13671_ANGE-RZ-LENS

TE Connectivity: 2213130-2 + OPTIC CLIP Z50 TYPE1 2213194-1

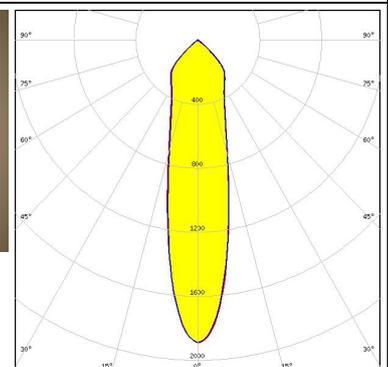

SHARP

LED Mega Zenigata (GW6DME)
 FWHM / FWTM 20.0° / 84.0°
 Efficiency 94 %
 Peak intensity 2.7 cd/lm
 LEDs/each optic 1
 Light colour White

Required components:

IDEAL: 50-2100SH + 50-2100AN

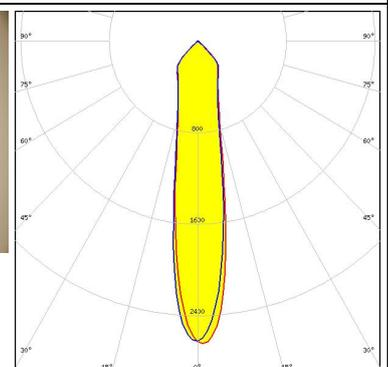
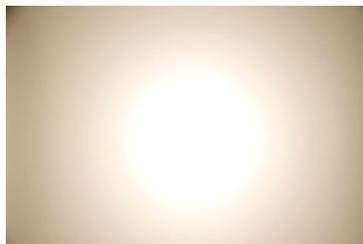

VS LIGHTING SOLUTIONS

LED WU-M-461
 FWHM / FWTM 20.0° / 78.0°
 Efficiency 94 %
 Peak intensity 2.7 cd/lm
 LEDs/each optic 1
 Light colour White

Required components:

TE Connectivity: OPTIC CLIP Z50 TYPE1 2213194-1

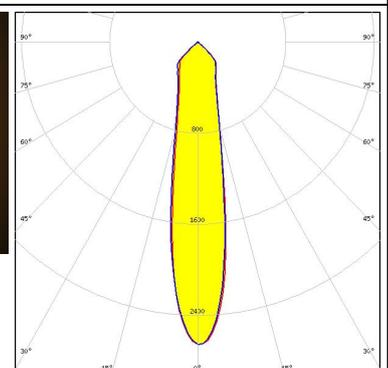

PHOTOMETRIC DATA (MEASURED):

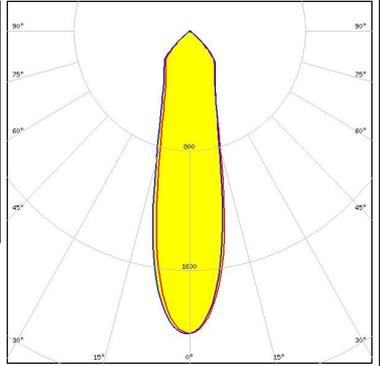
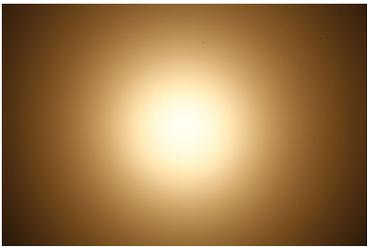
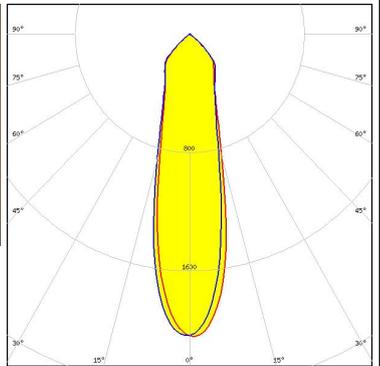
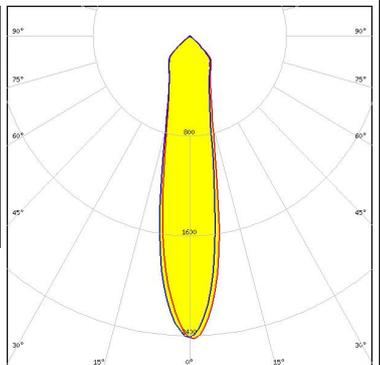
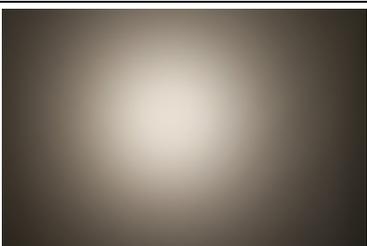
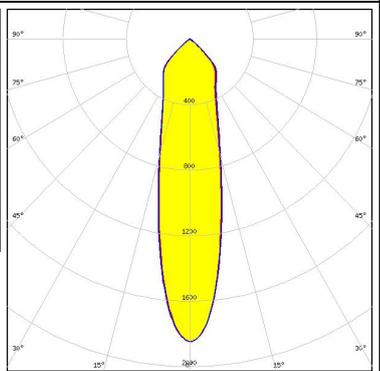
<p>VS LIGHTING SOLUTIONS</p> <p>LED WU-M-462 FWHM / FWTM 26.0° / 89.0° Efficiency 94 % Peak intensity 2 cd/m LEDs/each optic 1 Light colour White</p> <p>Required components: TE Connectivity: OPTIC CLIP Z50 TYPE1 2213194-1</p>		
<p>VS LIGHTING SOLUTIONS</p> <p>LED WU-M-464 FWHM / FWTM 26.0° / 89.0° Efficiency 94 % Peak intensity 2 cd/m LEDs/each optic 1 Light colour White</p> <p>Required components: TE Connectivity: OPTIC CLIP Z50 TYPE1 2213194-1</p>		
<p>VS LIGHTING SOLUTIONS</p> <p>LED WU-M-484 FWHM / FWTM 21.0° / 88.0° Efficiency 93 % Peak intensity 2.4 cd/m LEDs/each optic 1 Light colour White</p> <p>Required components: TE Connectivity: OPTIC CLIP Z50 TYPE1 2213194-1</p>		
<p>VS LIGHTING SOLUTIONS</p> <p>LED WU-M-484 FWHM / FWTM 25.0° / 91.0° Efficiency 88 % Peak intensity 1.8 cd/m LEDs/each optic 1 Light colour White</p> <p>Required components: C13333_MIRELLA-CL TE Connectivity: OPTIC CLIP Z50 TYPE1 2213194-1</p>		

PHOTOMETRIC DATA (MEASURED):

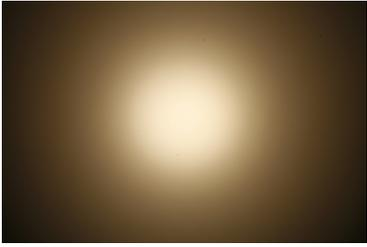
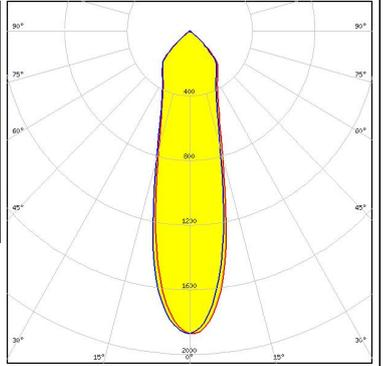
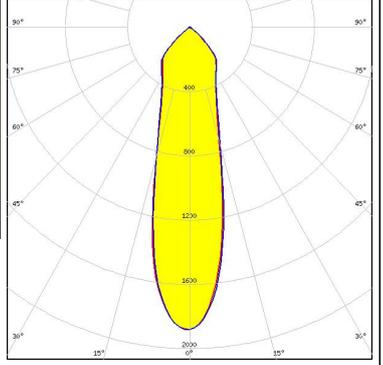
<p>VS LIGHTING SOLUTIONS</p> <p>LED WU-M-485 FWHM / FWTM 27.0° / 81.0° Efficiency 93 % Peak intensity 1.9 cd/m LEDs/each optic 1 Light colour White Required components: TE Connectivity: OPTIC CLIP Z50 TYPE1 2213194-1</p>		
<p>VS LIGHTING SOLUTIONS</p> <p>LED WU-M-486 FWHM / FWTM 26.0° / 91.0° Efficiency 93 % Peak intensity 1.9 cd/m LEDs/each optic 1 Light colour White Required components: TE Connectivity: OPTIC CLIP Z50 TYPE1 2213194-1</p>		

PHOTOMETRIC DATA (SIMULATED):

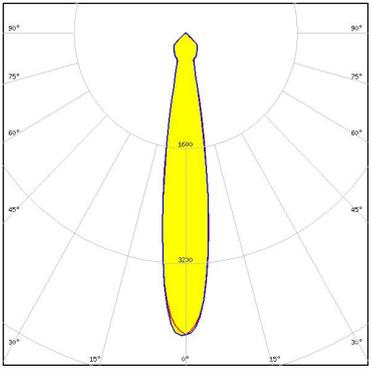
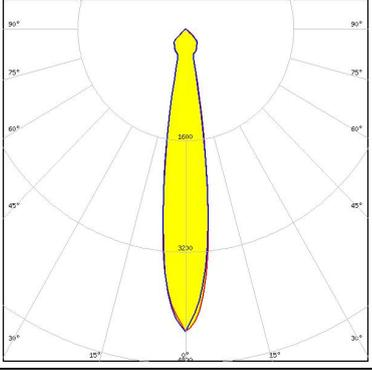
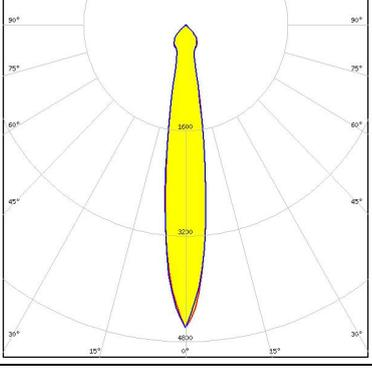
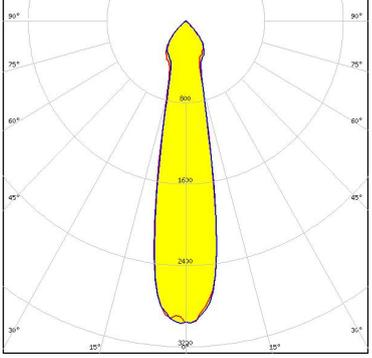
<p></p> <p>LED V10 Gen7 FWHM / FWTM 17.0° / 33.0° Efficiency 94 % Peak intensity 4.2 cd/lm LEDs/each optic 1 Light colour White Required components: C13584_CLAMP-VERO29 Bender Wirth: 486 Typ L1</p>	
<p></p> <p>LED V10 Gen7 FWHM / FWTM 17.0° / 32.0° Efficiency 94 % Peak intensity 4.3 cd/lm LEDs/each optic 1 Light colour White Required components: C13658_CLAMP-VERO13-18 Bender Wirth: 486 Typ L1</p>	
<p></p> <p>LED V13 Gen7 FWHM / FWTM 16.0° / 34.0° Efficiency 93 % Peak intensity 4.6 cd/lm LEDs/each optic 1 Light colour White Required components: IDEAL: 50-2103CT + 50-2100AN</p>	
<p></p> <p>LED V22 Gen7 FWHM / FWTM 21.0° / 74.0° Efficiency 94 % Peak intensity 3 cd/lm LEDs/each optic 1 Light colour White Required components: IDEAL: 50-2204-CT + 50-2100AN</p>	

PHOTOMETRIC DATA (SIMULATED):



LED CxM-14 (19x19)
FWHM / FWTM 21.0° / 89.0°
Efficiency 92 %
Peak intensity 2.3 cd/lm
LEDs/each optic 1
Light colour White
Required components:
C13658_CLAMP-VERO13-18
Bender Wirth: 433 Typ L1



LED CxM-9 (13.5x13.5)
FWHM / FWTM 17.0° / 75.0°
Efficiency 93 %
Peak intensity 2.9 cd/lm
LEDs/each optic 1
Light colour White
Required components:
C13658_CLAMP-VERO13-18
Bender Wirth: 434 Typ L1



SEOUL SEMICONDUCTOR

LED ZC12/18
FWHM / FWTM 21.0° / 89.0°
Efficiency 92 %
Peak intensity 2.3 cd/lm
LEDs/each optic 1
Light colour White
Required components:
C13658_CLAMP-VERO13-18
Bender Wirth: 433 Typ L1



SEOUL SEMICONDUCTOR

LED ZC4/6
FWHM / FWTM 17.0° / 75.0°
Efficiency 93 %
Peak intensity 2.9 cd/lm
LEDs/each optic 1
Light colour White
Required components:
C13658_CLAMP-VERO13-18
Bender Wirth: 434 Typ L1

GENERAL INFORMATION:

NOTE: The typical beam angle will be changed by different color, chip size and chip position tolerance. The typical total beam angle is the full angle measured where the luminous intensity is half of the peak value.

Due to use of high power COB's with this product, special attention to proper thermal design is highly recommended. LEDiL has no liability for direct, indirect or consecutive damages arising from the LEDiL products being used outside of the recommended temperature range.

MATERIALS:

As part of our continuous research and improvement processes, and to ensure the best possible quality and availability of our products, LEDiL reserves the right to change material grades without notice.

PRODUCT DATA USER AGREEMENT AND DISCLAIMER:

The measured data in the provided downloadable LEDiL Product Datasheets and Mechanical 2D-Drawings is rounded and provided as reference for planning. LEDiL Oy's optical specifications have been verified by conducting performance testing of the products in accordance with the company's quality system. The reported data are averaged results of multiple measurements with typical variation. LEDiL Oy reserves the right to without prior notification make changes and improvements to its products.

LEDiL Oy assumes neither warranty, nor guarantee nor any other liability of any kind for the contents and correctness of the provided data. The provided data has been generated with highest diligence but the provided data may in reality not represent the complete possible variation range of all intrinsic parameters. Therefore, in certain cases a deviation from the provided data could occur.

LEDiL Oy reserves the right to undertake technical changes of its products without further notification which could lead to changes in the provided data. LEDiL Oy assumes no liability of any kind for the possible deviation from any provided data or any other damage resulting from the usage of the provided data.

The user agrees to this disclaimer and user agreement with the download or usage of the provided files.

LEDiL Oy

Joensuunkatu 13
FI-24240 SALO
Finland

LEDiL Inc.

228 West Page Street
Suite D
Sycamore IL 60178
USA

Ledil Optics Technology (Shenzhen) Co., Ltd.

405 , Block B
Casic Motor Building
Shenzhen 518057
P.R.CHINA

Local sales and technical support

[www.ledil.com/
where_to_buy](http://www.ledil.com/where_to_buy)

Shipping locations

Salo, Finland
Hong Kong, China

Distribution Partners

[www.ledil.com/
where_to_buy](http://www.ledil.com/where_to_buy)

X-ON Electronics

Largest Supplier of Electrical and Electronic Components

Click to view similar products for [LED Lighting Reflectors](#) category:

Click to view products by [Ledil](#) manufacturer:

Other Similar products are found below :

[LL04CR-CFN35155L02](#) [LL04CR-CFN60155L02](#) [LL04CR-CGM85135L02](#) [F13185_GERI-RZ](#) [10604](#) [LL01SP-ATH15R49](#) [10170](#) [12527](#)
[12531](#) [12568](#) [C13253_TINA2-R-CLIP16](#) [CA14591_BROOKE-XW](#) [F15560_MIRELLA-G2-W](#) [CA11525_LAURA-R-W](#) [12796](#) [LMH020-](#)
[REFL-0000-0000062](#) [LMH020-REFL-0000-0000082](#) [C12606_LENINA-DL](#) [CN12711_LENINA-W-DL](#) [C11394_TYRA-S](#) [C11396_TYRA-](#)
[W](#) [C11508_BROOKE-W](#) [C11552_BARBARA-S](#) [C11553_BARBARA-W](#) [C11862_MINNIE-W](#) [C11979_LENA-S](#) [C11980_LENA-W](#)
[C11996_LENA-LENS](#) [C12083_BROOKE-SCR-M](#) [C12095_MINNIE-M](#) [C12097_MINNIE-WWW](#) [C12154_LENA-M](#) [C12469_LISA2-R-](#)
[PIN](#) [C12476_MIRELLA-50-S](#) [C12477_MIRELLA-50-M](#) [C12480_MIRELLA-50-S-PIN](#) [C12516_RITA-WAS](#) [C12597_LENINA-S](#)
[C12599_LENINA-W](#) [C12948_LENA-WAS](#) [C12958_LENINA-XW](#) [C13085_MIRELLA-50-S-PF](#) [C13087_MIRELLA-50-W-PF](#)
[C13101_LENA-X-WAS](#) [C13555_BRIDGET-W-UNI](#) [C13556_BRIDGET-M-UNI](#) [C13557_BRIDGET-S-UNI](#) [C14346_ANGELETTE-WAS](#)
[C17099_ALISE-50-DL](#) [C17095_ALISE-70-CL](#)