

ANGELA-W-B

~45° wide beam compatible with BJB connectors

TECHNICAL SPECIFICATIONS:

Dimensions	Ø 119.5 mm
Height	74.5 mm
Fastening	socket
ROHS compliant	yes ⓘ

MATERIAL SPECIFICATIONS:

Component	Type	Material	Colour	Finish	Coating
ANGELA-W-B	Reflector	PC	metal		HMDS

ORDERING INFORMATION:

Component	Qty in box	MOQ	MPQ	Box weight (kg)
F13664_ANGELA-W-B » Box size: 398 x 298 x 265 mm	180	90	45	9.1



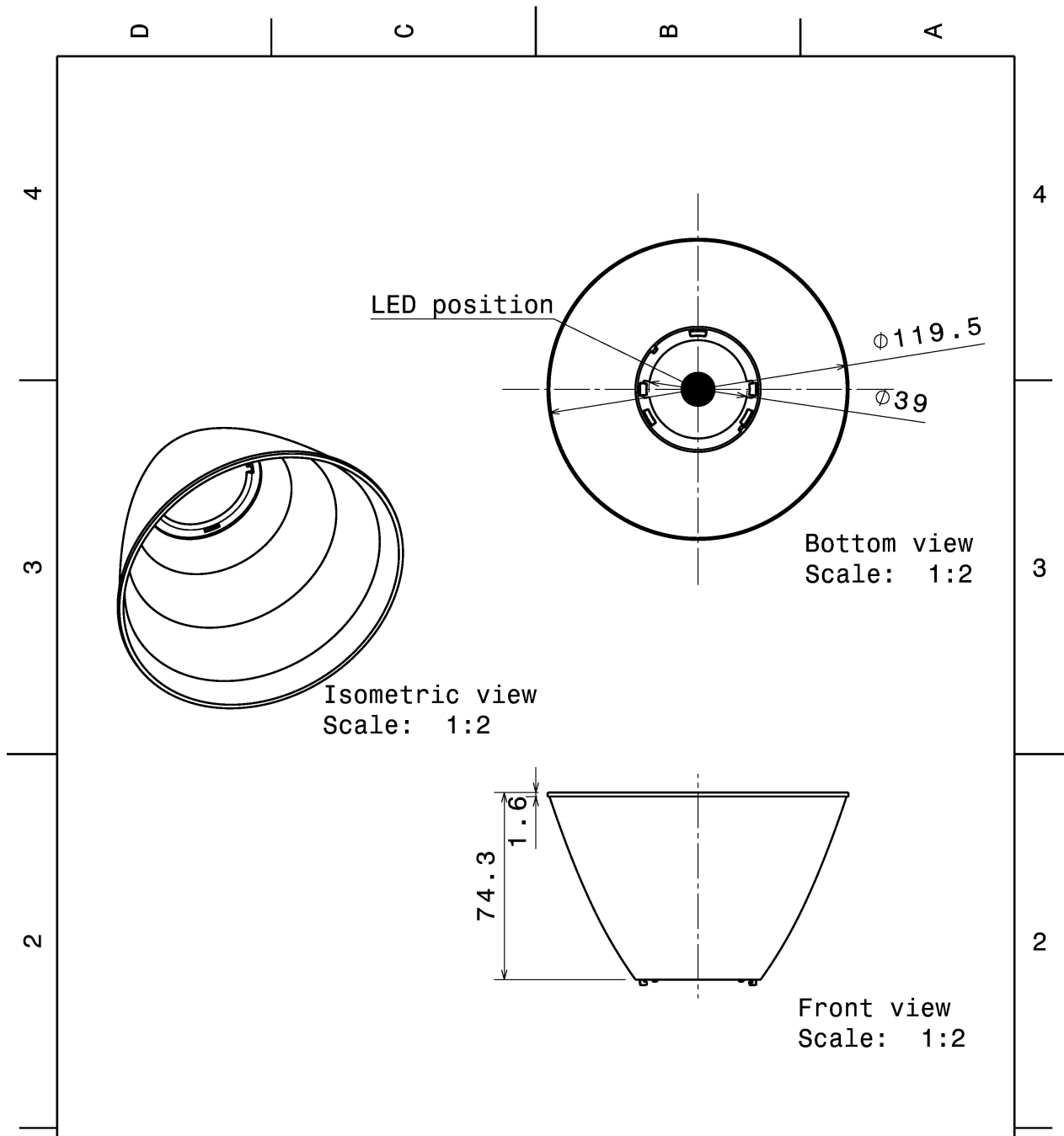

Tolerances if not otherwise shown
According to DIN ISO 2768-1
Linear measures:
Up to 30mm class M, otherwise class C.
According to DIN ISO 2768-2
Form and position: class L

LEDiL Ledil Oy
Salorankatu 10
FIN 24240 SALO
Finland

THIRD ANGLE PROJECTION:

DRAWING TITLE
Angela-B







This drawing is the property of LEDiL Oy. It may not be reproduced, copied or communicated without a written agreement with LEDiL Oy."

SIZE	PART NUMBER
A4	-

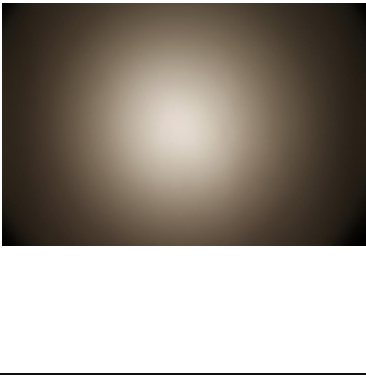
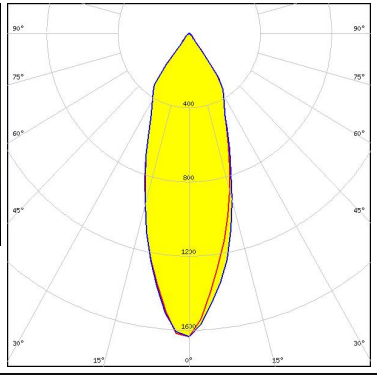

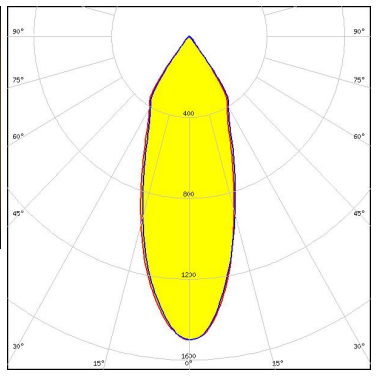

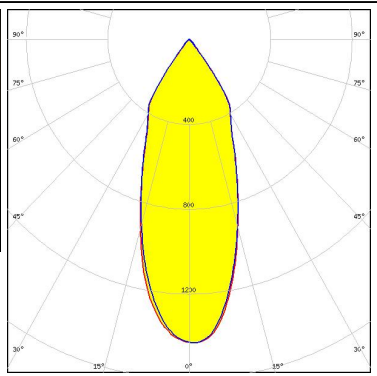

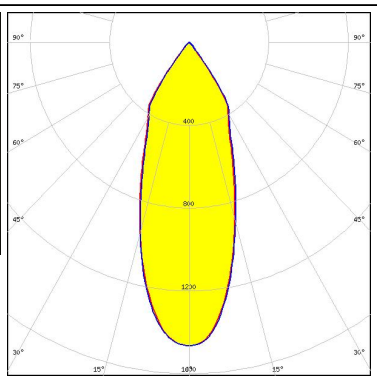
SCALE	1:2	WEIGHT	-	SHEET	1/1
-------	-----	--------	---	-------	-----

See also our general installation guide: www.ledil.com/installation_guide

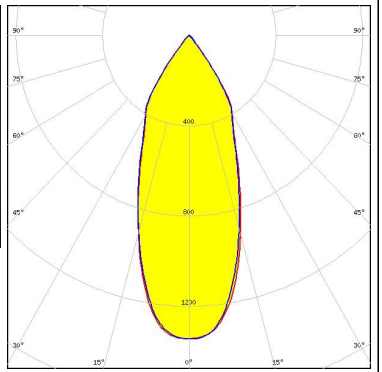
PHOTOMETRIC DATA (MEASURED):

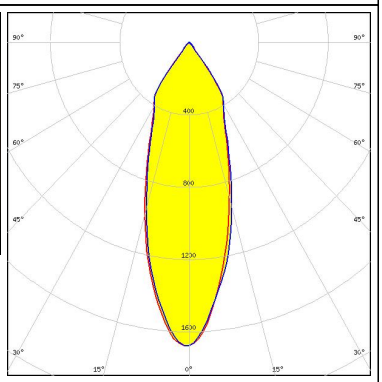
<p></p> <p>LED BXRA ES Rectangle</p> <p>FWHM / FWTM 34.0° / 75.0°</p> <p>Efficiency 83 %</p> <p>Peak intensity 1.7 cd/lm</p> <p>LEDs/each optic 1</p> <p>Light colour White</p> <p>Required components: BJB: 47.319.2040</p>		
<p></p> <p>LED V15 Gen6</p> <p>FWHM / FWTM 37.0° / 75.0°</p> <p>Efficiency 81 %</p> <p>Peak intensity 1.5 cd/lm</p> <p>LEDs/each optic 1</p> <p>Light colour White</p> <p>Required components: BJB: 47.319.2224</p>		
<p></p> <p>LED V18 Gen6</p> <p>FWHM / FWTM 38.0° / 76.0°</p> <p>Efficiency 81 %</p> <p>Peak intensity 1.4 cd/lm</p> <p>LEDs/each optic 1</p> <p>Light colour White</p> <p>Required components:</p>		
<p></p> <p>LED V18 Gen7</p> <p>FWHM / FWTM 38.0° / 76.0°</p> <p>Efficiency 82 %</p> <p>Peak intensity 1.5 cd/lm</p> <p>LEDs/each optic 1</p> <p>Light colour White</p> <p>Required components: BJB: 47.319.2350</p>		

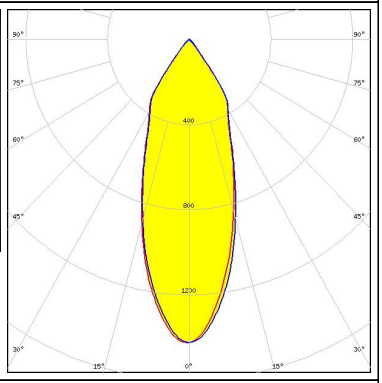
PHOTOMETRIC DATA (MEASURED):

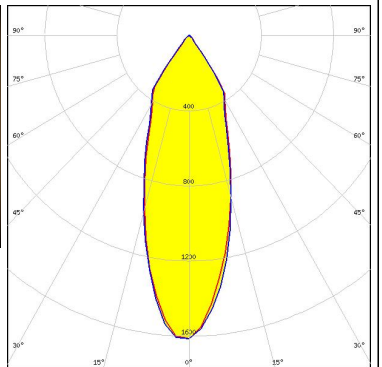
<p>bridgelux.</p> <p>LED V22 Gen6 FWHM / FWTM 40.0° / 76.0° Efficiency 80 % Peak intensity 1.3 cd/lm LEDs/each optic 1 Light colour White Required components:</p>		
<p>CITIZEN</p> <p>LED CLL03x/CLU03x FWHM / FWTM 33.0° / 75.0° Efficiency 83 % Peak intensity 1.7 cd/lm LEDs/each optic 1 Light colour White Required components: BJB: 47.319.2021</p>		
<p>CITIZEN</p> <p>LED CLL03x/CLU03x FWHM / FWTM 37.0° / 76.0° Efficiency 78 % Peak intensity 1.4 cd/lm LEDs/each optic 1 Light colour White Required components: F13671_ANGLE-RZ-LENS A.A.G. STUCCHI: 8101-G2</p>		
<p>CITIZEN</p> <p>LED CLL03x/CLU03x FWHM / FWTM 34.0° / 75.0° Efficiency 83 % Peak intensity 1.6 cd/lm LEDs/each optic 1 Light colour White Required components: A.A.G. STUCCHI: 8101-G2</p>		

PHOTOMETRIC DATA (MEASURED):

CITIZEN

LED CLL04x/CLU04x
 FWHM / FWTM 38.0° / 76.0°
 Efficiency 82 %
 Peak intensity 1.5 cd/lm
 LEDs/each optic 1
 Light colour White
 Required components:
 BJB: 47.319.2030

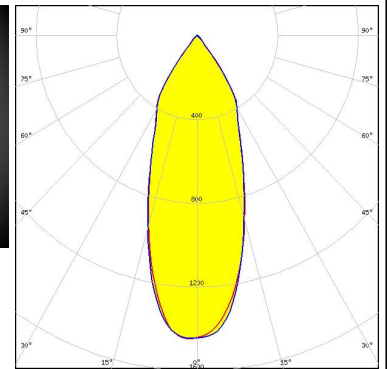
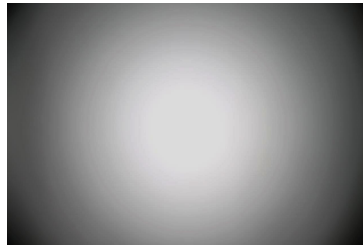

CITIZEN

LED CLL04x/CLU04x
 FWHM / FWTM 41.0° / 78.0°
 Efficiency 77 %
 Peak intensity 1.3 cd/lm
 LEDs/each optic 1
 Light colour White
 Required components:
 F13671_ANGLE-RZ-LENS
 A.A.G. STUCCHI: 8102-G2

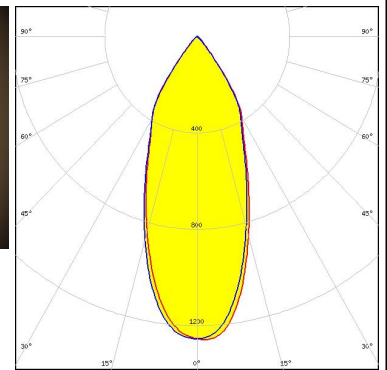
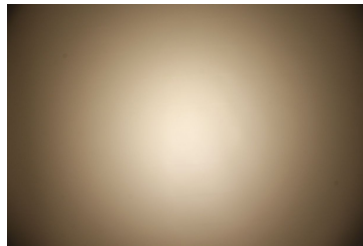

CITIZEN

LED CLL04x/CLU04x
 FWHM / FWTM 39.0° / 77.0°
 Efficiency 82 %
 Peak intensity 1.4 cd/lm
 LEDs/each optic 1
 Light colour White
 Required components:
 A.A.G. STUCCHI: 8102-G2

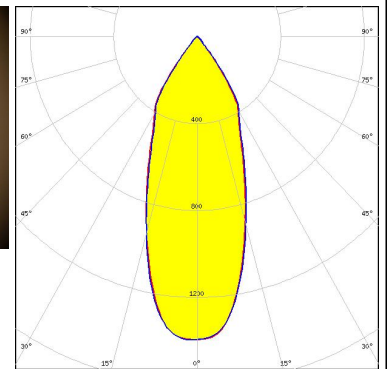
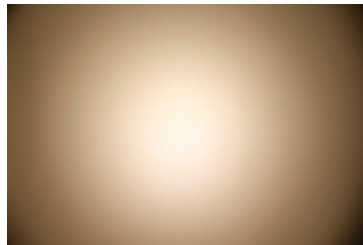

CITIZEN

LED CLU720/721
 FWHM / FWTM 32.0° / 75.0°
 Efficiency 83 %
 Peak intensity 1.7 cd/lm
 LEDs/each optic 1
 Light colour White
 Required components:
 BJB: 47.319.2021

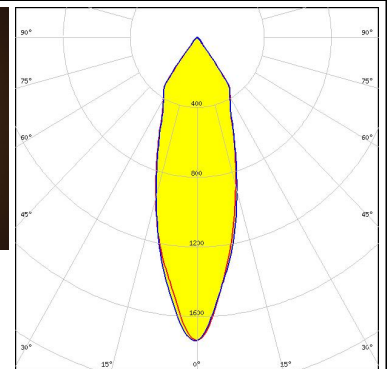
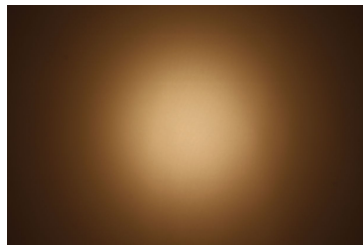

PHOTOMETRIC DATA (MEASURED):

CITIZEN

LED CLU720/721
 FWHM / FWTM 32.0° / 74.0°
 Efficiency 84 %
 Peak intensity 1.7 cd/lm
 LEDs/each optic 1
 Light colour White
 Required components:
 A.A.G. STUCCHI: 8101-G2

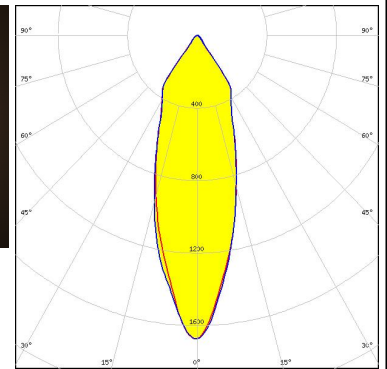
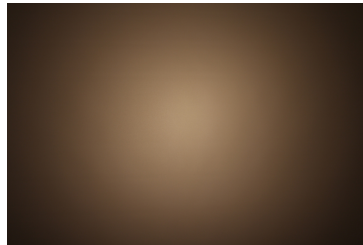

CREE LED

LED CXA/B 25xx
 FWHM / FWTM 38.0° / 76.0°
 Efficiency 80 %
 Peak intensity 1.4 cd/lm
 LEDs/each optic 1
 Light colour White
 Required components:

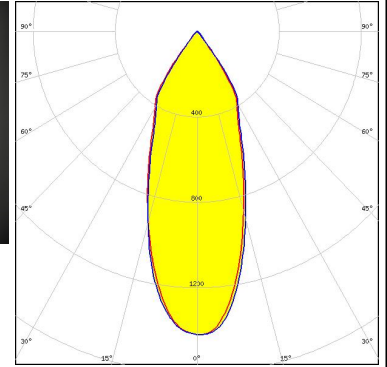

CREE LED

LED CXA/B 25xx
 FWHM / FWTM 37.0° / 76.0°
 Efficiency 82 %
 Peak intensity 1.5 cd/lm
 LEDs/each optic 1
 Light colour White
 Required components:
 A.A.G. STUCCHI: 8401-G2

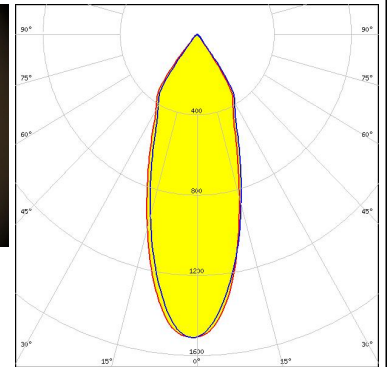
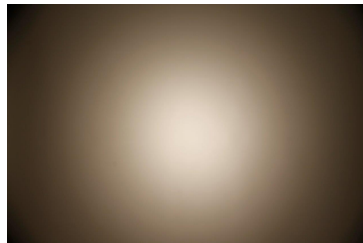

CREE LED

LED CXA/B 25xx
 FWHM / FWTM 40.0° / 77.0°
 Efficiency 77 %
 Peak intensity 1.3 cd/lm
 LEDs/each optic 1
 Light colour White
 Required components:
 F13671_ANGLE-RZ-LENS
 BJB: 47.319.2141

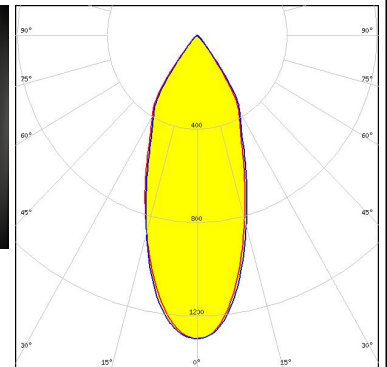
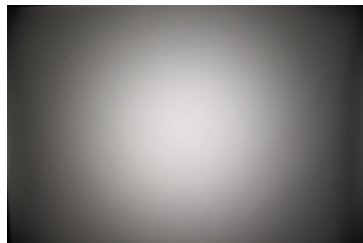

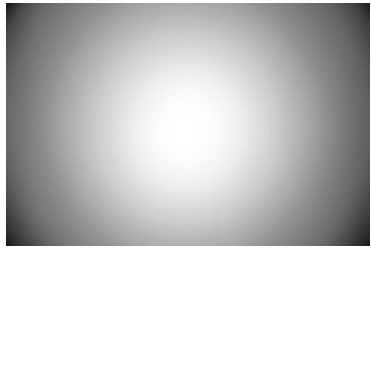
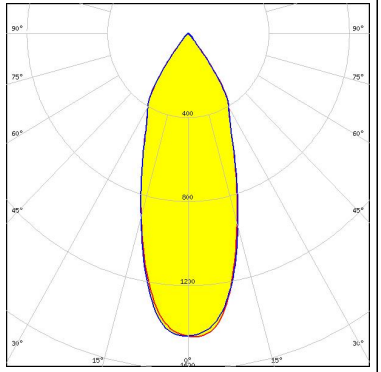
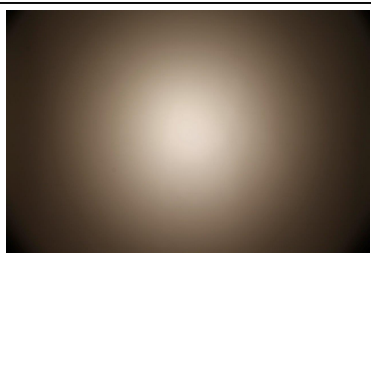
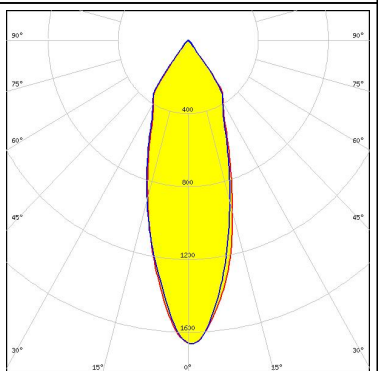
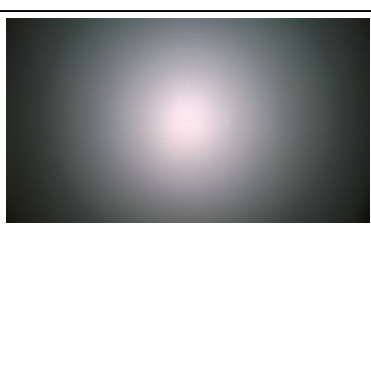
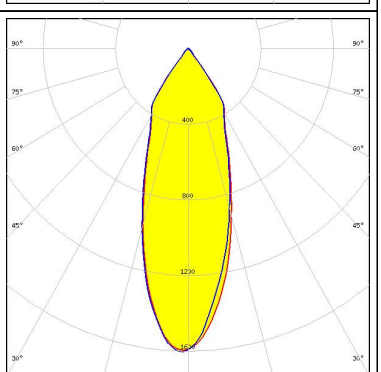
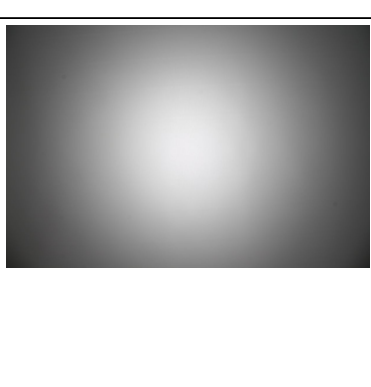
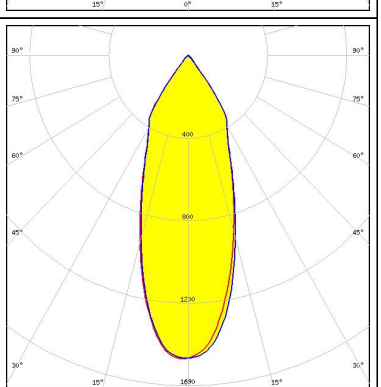

PHOTOMETRIC DATA (MEASURED):

<p>CREE LED</p> <p>LED CXA/B 30xx FWHM / FWTM 38.0° / 75.0° Efficiency 81 % Peak intensity 1.5 cd/lm LEDs/each optic 1 Light colour White Required components: A.A.G. STUCCHI: 8404-G2</p>		
<p>LUMILEDS</p> <p>LED LUXEON CoB 1204/1205 FWHM / FWTM 33.0° / 75.0° Efficiency 83 % Peak intensity 1.7 cd/lm LEDs/each optic 1 Light colour White Required components: A.A.G. STUCCHI: 8301-G2</p>		
<p>LUMILEDS</p> <p>LED LUXEON CoB 1208 FWHM / FWTM 35.0° / 75.0° Efficiency 84 % Peak intensity 1.6 cd/lm LEDs/each optic 1 Light colour White Required components: A.A.G. STUCCHI: 8301-G2</p>		
<p>LUMILEDS</p> <p>LED LUXEON CoB 1211 FWHM / FWTM 37.0° / 76.0° Efficiency 81 % Peak intensity 1.5 cd/lm LEDs/each optic 1 Light colour White Required components: BJB: 47.319.2030</p>		

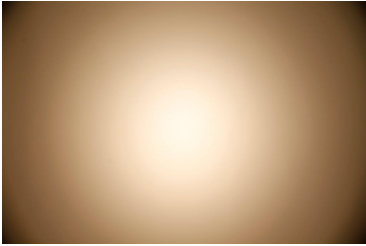
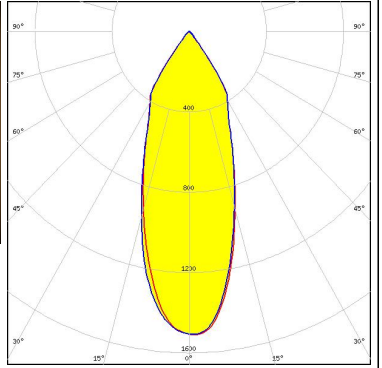
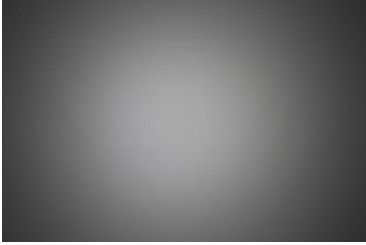
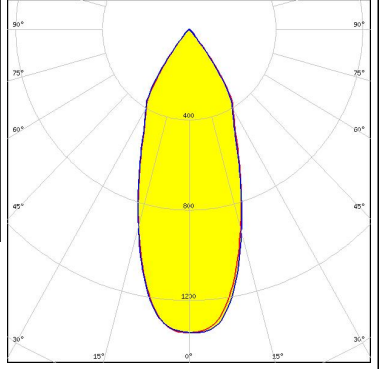
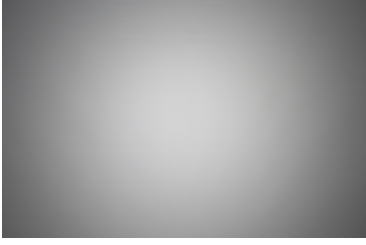
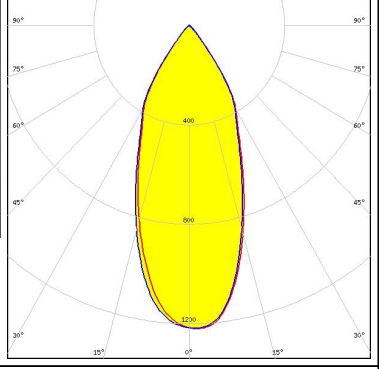
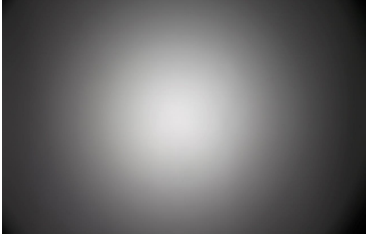
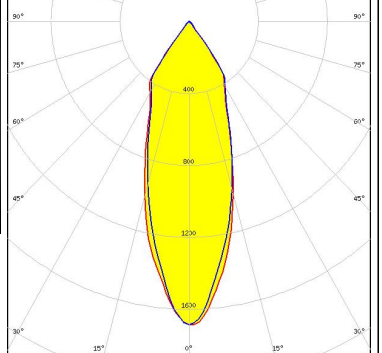
PHOTOMETRIC DATA (MEASURED):

<p>LUMILEDS</p> <p>LED LUXEON CoB 1211</p> <p>FWHM / FWTM 37.0° / 75.0°</p> <p>Efficiency 82 %</p> <p>Peak intensity 1.5 cd/lm</p> <p>LEDs/each optic 1</p> <p>Light colour White</p> <p>Required components: A.A.G. STUCCHI: 8102-G2</p>		
<p>LUMILEDS</p> <p>LED LUXEON CoB 1216/1812</p> <p>FWHM / FWTM 40.0° / 76.0°</p> <p>Efficiency 80 %</p> <p>Peak intensity 1.4 cd/lm</p> <p>LEDs/each optic 1</p> <p>Light colour White</p> <p>Required components:</p>		
<p>LUMILEDS</p> <p>LED LUXEON CoB 1216/1812</p> <p>FWHM / FWTM 42.0° / 78.0°</p> <p>Efficiency 76 %</p> <p>Peak intensity 1.2 cd/lm</p> <p>LEDs/each optic 1</p> <p>Light colour White</p> <p>Required components: F13671_ANGLE-RZ-LENS BJB: 47.319.2030</p>		
<p>LUMILEDS</p> <p>LED LUXEON K12</p> <p>FWHM / FWTM 35.0° / 76.0°</p> <p>Efficiency 87 %</p> <p>Peak intensity 1.7 cd/lm</p> <p>LEDs/each optic 1</p> <p>Light colour White</p> <p>Required components: BJB: 47.319.2070</p>		

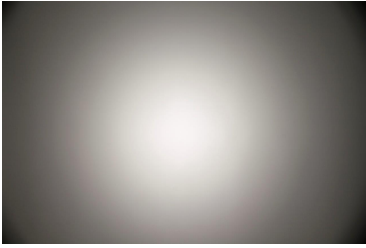
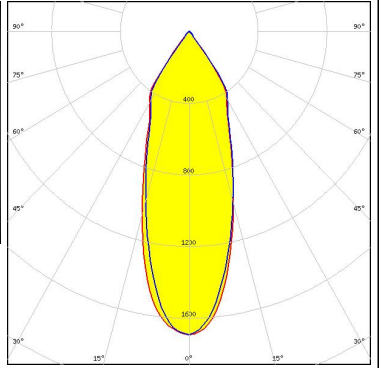
PHOTOMETRIC DATA (MEASURED):

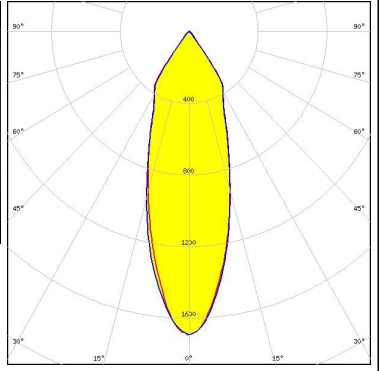
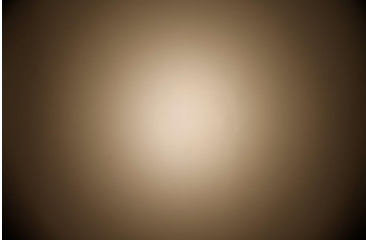
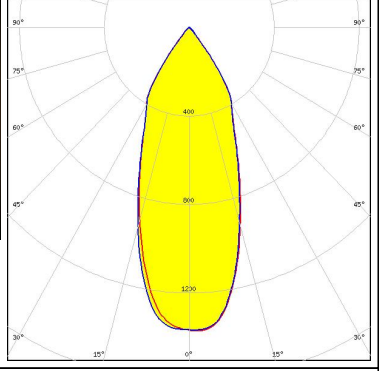
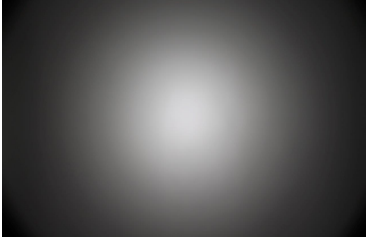
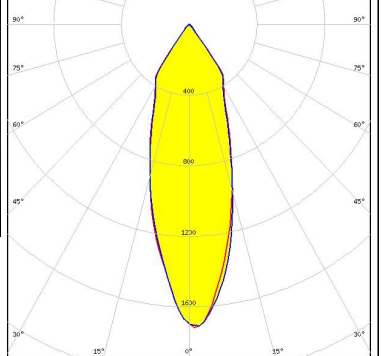
<p>LUMILEDS</p> <p>LED LUXEON K16</p> <p>FWHM / FWTM 36.0° / 75.0°</p> <p>Efficiency 88 %</p> <p>Peak intensity 1.7 cd/lm</p> <p>LEDs/each optic 1</p> <p>Light colour White</p> <p>Required components: BJB: 47.319.2070</p>		
<p>LUMINUS</p> <p>LED CxM-14 (19x19)</p> <p>FWHM / FWTM 33.0° / 74.0°</p> <p>Efficiency 83 %</p> <p>Peak intensity 1.7 cd/lm</p> <p>LEDs/each optic 1</p> <p>Light colour White</p> <p>Required components: BJB: 47.319.2021</p>		
<p>LUMINUS</p> <p>LED CxM-22 (28x28)</p> <p>FWHM / FWTM 40.0° / 77.0°</p> <p>Efficiency 81 %</p> <p>Peak intensity 1.4 cd/lm</p> <p>LEDs/each optic 1</p> <p>Light colour White</p> <p>Required components: BJB: 47.319.2030</p>		
<p>OSRAM Opto Semiconductors</p> <p>LED Soleriq S13</p> <p>FWHM / FWTM 33.0° / 75.0°</p> <p>Efficiency 84 %</p> <p>Peak intensity 1.7 cd/lm</p> <p>LEDs/each optic 1</p> <p>Light colour White</p> <p>Required components: A.A.G. STUCCHI: 8502-G2</p>		

PHOTOMETRIC DATA (MEASURED):

OSRAM

Opto Semiconductors

LED Soleriq S13 19x19
 FWHM / FWTM 34.0° / 75.0°
 Efficiency 81 %
 Peak intensity 1.6 cd/lm
 LEDs/each optic 1
 Light colour White
 Required components:
 BJB: 47.319.2021

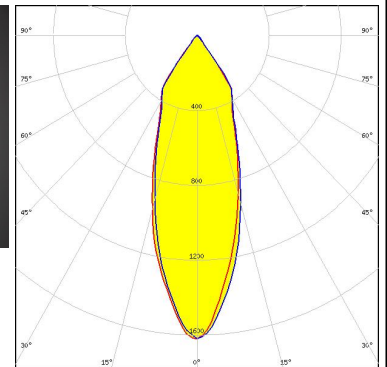
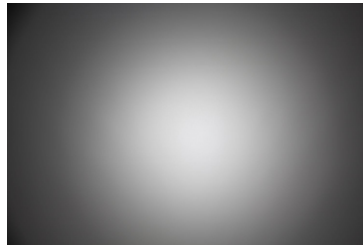

OSRAM

Opto Semiconductors

LED Soleriq S19
 FWHM / FWTM 35.0° / 75.0°
 Efficiency 83 %
 Peak intensity 1.6 cd/lm
 LEDs/each optic 1
 Light colour White
 Required components:
 BJB: 47.319.2170

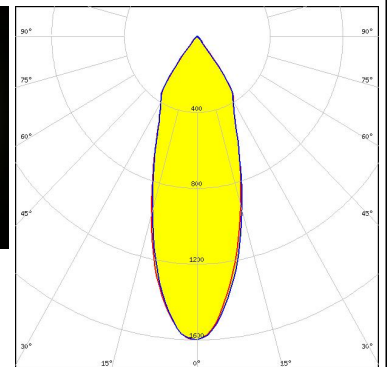
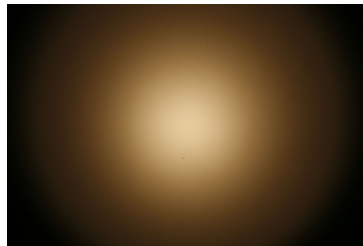

PHILIPS

LED Fortimo SLM L19 CoB
 FWHM / FWTM 35.0° / 75.0°
 Efficiency 87 %
 Peak intensity 1.7 cd/lm
 LEDs/each optic 1
 Light colour White
 Required components:
 BJB: 47.319.2030

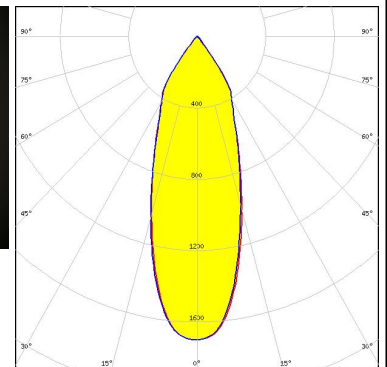
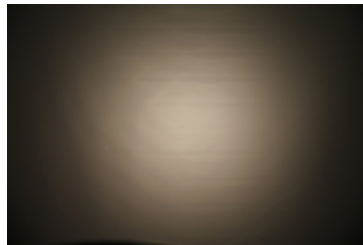

PHILIPS

LED Fortimo SLM L19 CoB
 FWHM / FWTM 38.0° / 76.0°
 Efficiency 82 %
 Peak intensity 1.5 cd/lm
 LEDs/each optic 1
 Light colour White
 Required components:
 F13671_ANGLE-RZ-LENS
 BJB: 47.319.2030

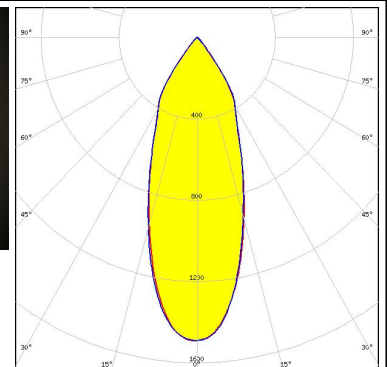
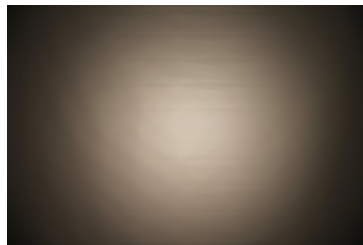

PHOTOMETRIC DATA (MEASURED):

PHILIPS

LED Fortimo SLM L23 CoB
 FWHM / FWTM 40.0° / 77.0°
 Efficiency 82 %
 Peak intensity 1.4 cd/lm
 LEDs/each optic 1
 Light colour White
 Required components:
 F13671_ANGE-RZ-LENS
 BJB: 47.319.2030

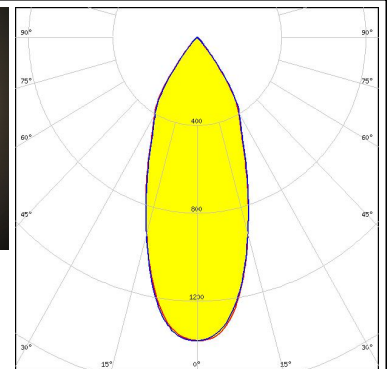
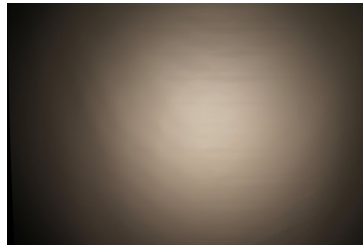

PHILIPS

LED Fortimo SLM L23 CoB
 FWHM / FWTM 39.0° / 76.0°
 Efficiency 86 %
 Peak intensity 1.5 cd/lm
 LEDs/each optic 1
 Light colour White
 Required components:
 BJB: 47.319.2030

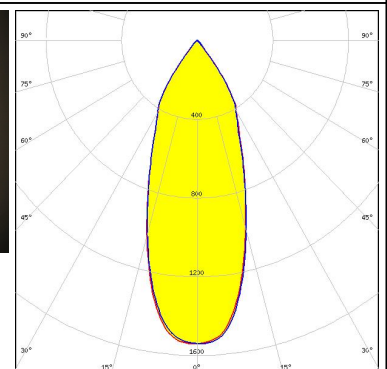
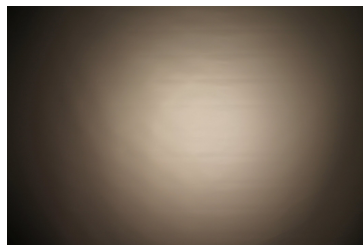

SAMSUNG

LED LC016D / LC019D / LC026D / LC033D
 FWHM / FWTM 36.0° / 76.0°
 Efficiency 82 %
 Peak intensity 1.6 cd/lm
 LEDs/each optic 1
 Light colour White
 Required components:
 BJB: 47.319.2021

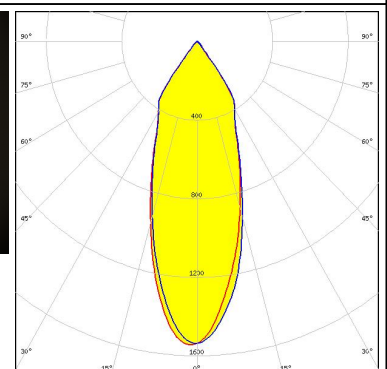
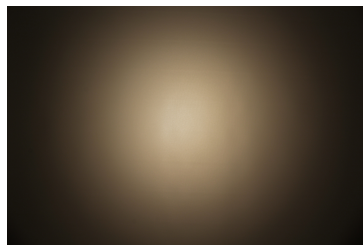

SAMSUNG

LED LC016D / LC019D / LC026D / LC033D
 FWHM / FWTM 36.0° / 76.0°
 Efficiency 82 %
 Peak intensity 1.6 cd/lm
 LEDs/each optic 1
 Light colour White
 Required components:
 A.A.G. STUCCHI: 8101-G2

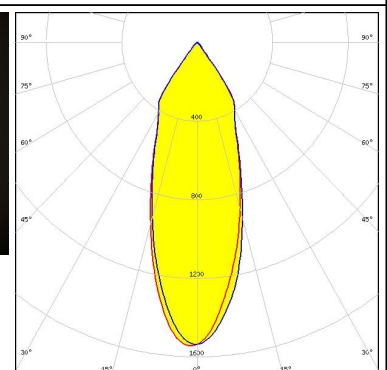
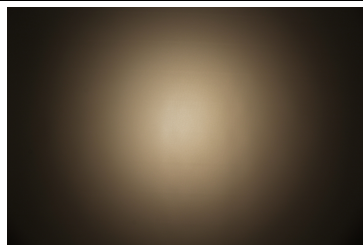

PHOTOMETRIC DATA (MEASURED):

SAMSUNG

LED LC016D / LC019D / LC026D / LC033D
 FWHM / FWTM 38.0° / 77.0°
 Efficiency 79 %
 Peak intensity 1.4 cd/m
 LEDs/each optic 1
 Light colour White
 Required components:
 F13671_ANGLE-RZ-LENS
 BJB: 47.319.2021

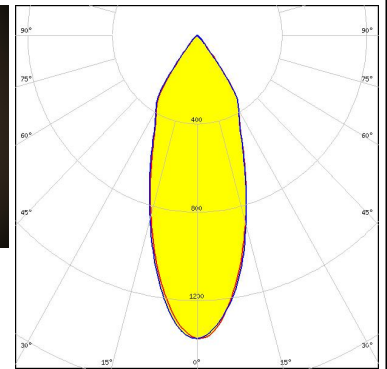
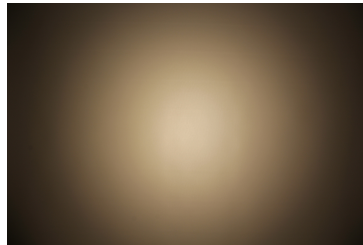

SAMSUNG

LED LC016D / LC019D / LC026D / LC033D
 FWHM / FWTM 38.0° / 77.0°
 Efficiency 79 %
 Peak intensity 1.4 cd/m
 LEDs/each optic 1
 Light colour White
 Required components:
 F13671_ANGLE-RZ-LENS
 A.A.G. STUCCHI: 8101-G2

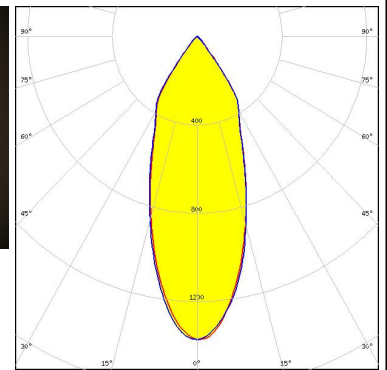
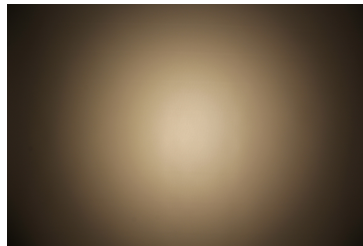

SEOUL SEMICONDUCTOR

LED ZC12/18
 FWHM / FWTM 34.0° / 74.0°
 Efficiency 83 %
 Peak intensity 1.7 cd/m
 LEDs/each optic 1
 Light colour White
 Required components:
 A.A.G. STUCCHI: 8101-G2

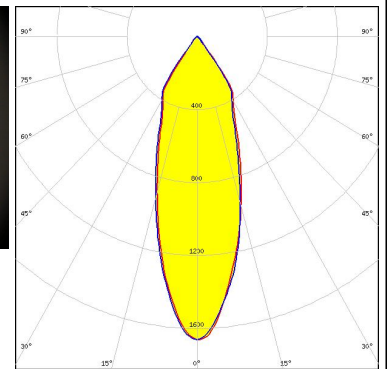
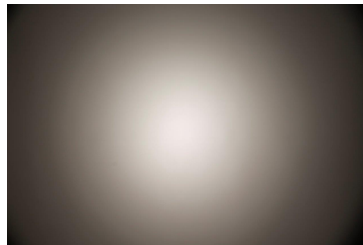



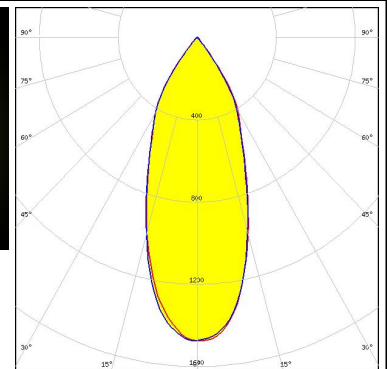
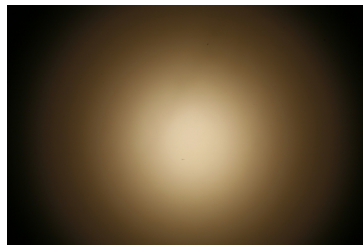

SEOUL SEMICONDUCTOR

LED ZC25/40/60
 FWHM / FWTM 40.0° / 76.0°
 Efficiency 82 %
 Peak intensity 1.5 cd/m
 LEDs/each optic 1
 Light colour White
 Required components:
 BJB: 47.319.2030

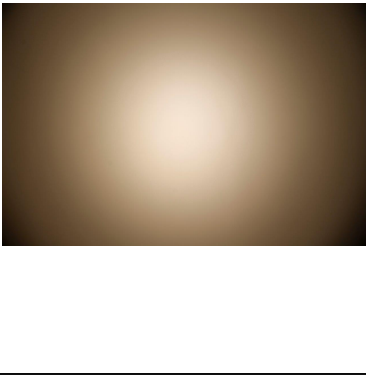
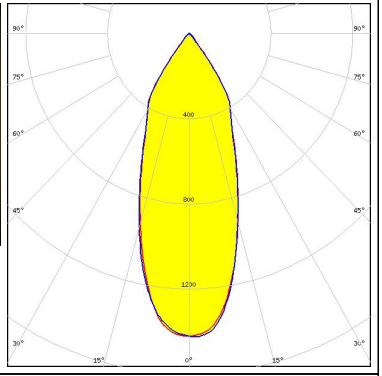

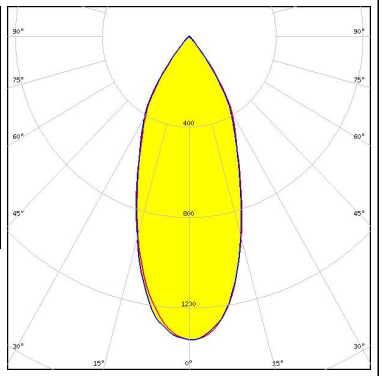
PHOTOMETRIC DATA (MEASURED):

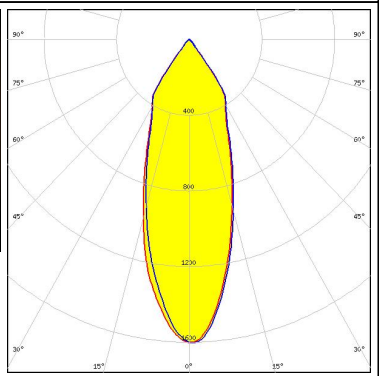
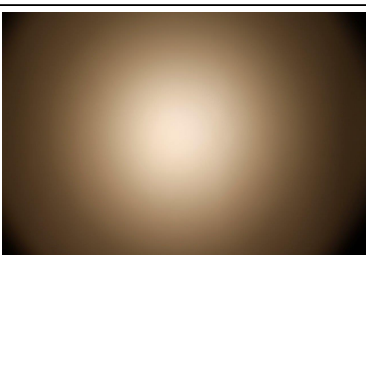
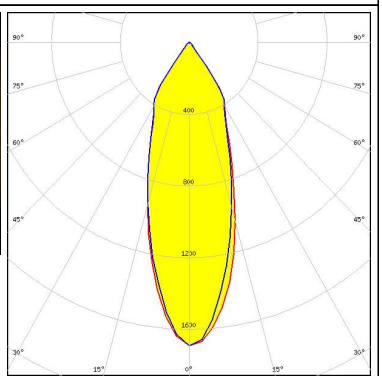
<p>SEOL SEOL SEMICONDUCTOR</p> <p>LED ZC25/40/60 FWHM / FWTM 39.0° / 76.0° Efficiency 82 % Peak intensity 1.4 cd/lm LEDs/each optic 1 Light colour White Required components: A.A.G. STUCCHI: 8102-G2</p>		
<p>SEOL SEOL SEMICONDUCTOR</p> <p>LED ZC25/40/60 FWHM / FWTM 42.0° / 78.0° Efficiency 79 % Peak intensity 1.3 cd/lm LEDs/each optic 1 Light colour White Required components: F13671_ANGLE-RZ-LENS BJB: 47.319.2030</p>		
<p>SHARP</p> <p>LED Mega Zenigata (GW6DME) FWHM / FWTM 35.0° / 75.0° Efficiency 84 % Peak intensity 1.6 cd/lm LEDs/each optic 1 Light colour White Required components: A.A.G. STUCCHI: 8301-G2</p>		
<p>SHARP</p> <p>LED Mega Zenigata (GW6DME) FWHM / FWTM 34.0° / 75.0° Efficiency 85 % Peak intensity 1.7 cd/lm LEDs/each optic 1 Light colour White Required components: BJB: 47.319.2011</p>		

PHOTOMETRIC DATA (MEASURED):

TRIDONIC

LED SLE G7 LES17 H
 FWHM / FWTM 34.0° / 74.0°
 Efficiency 81 %
 Peak intensity 1.6 cd/lm
 LEDs/each optic 1
 Light colour White
 Required components:

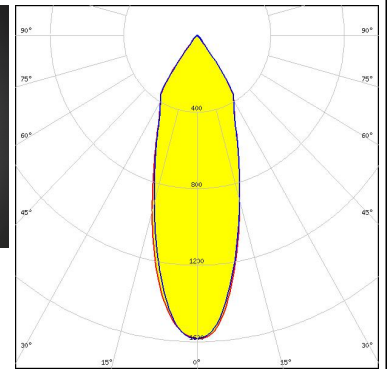
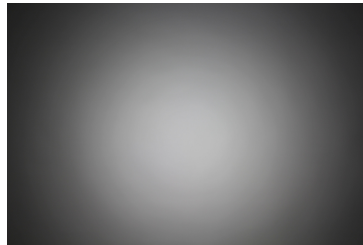

TRIDONIC

LED SLE G7 LES21 H
 FWHM / FWTM 37.0° / 75.0°
 Efficiency 81 %
 Peak intensity 1.5 cd/lm
 LEDs/each optic 1
 Light colour White
 Required components:

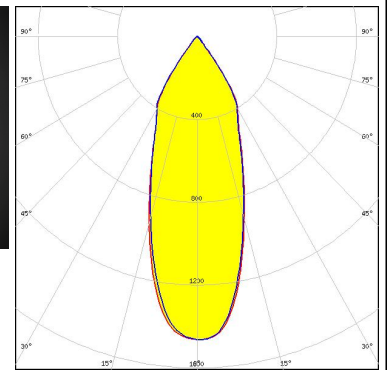
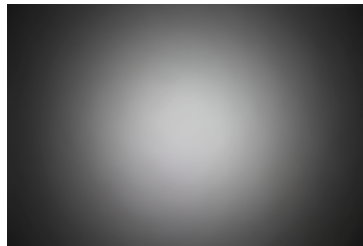

XICATO

LED XOB 14.5 mm
 FWHM / FWTM 36.0° / 75.0°
 Efficiency 83 %
 Peak intensity 1.6 cd/lm
 LEDs/each optic 1
 Light colour White
 Required components:
 BJB: 47.319.2021

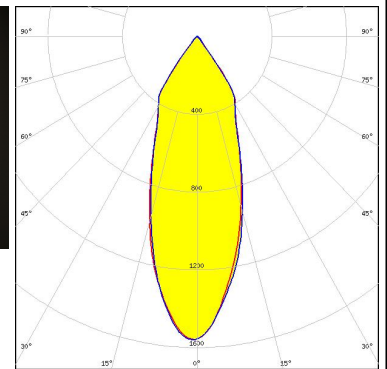
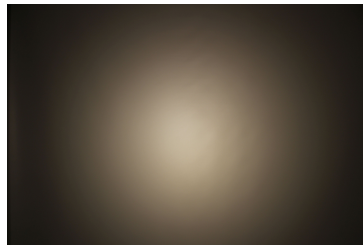

XICATO

LED XTM - 19mm LES
 FWHM / FWTM 37.0° / 76.0°
 Efficiency 82 %
 Peak intensity 1.5 cd/lm
 LEDs/each optic 1
 Light colour White
 Required components:
 C15743_XTM-ADAPTER-50-B

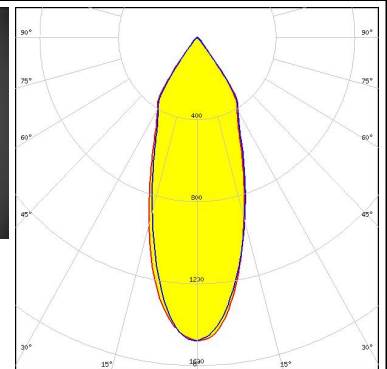
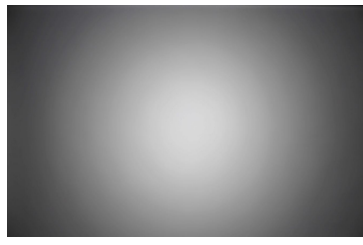

PHOTOMETRIC DATA (SIMULATED):

CITIZEN

LED CLL03x/CLU03x
 FWHM / FWTM 40.0° / 70.0°
 Efficiency 85 %
 Peak intensity 1.8 cd/lm
 LEDs/each optic 1
 Light colour White
 Required components:
 F13671_ANGE-RZ-LENS
 BJB: 47.319.2021

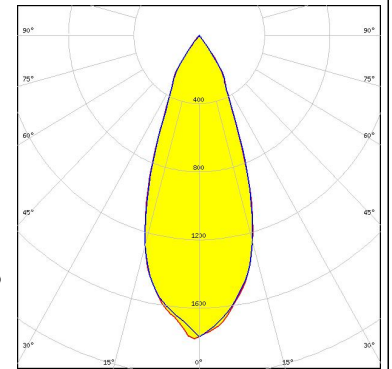
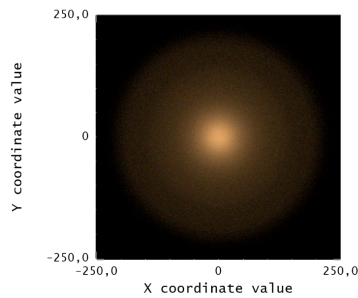

CITIZEN

LED CLU730/731
 FWHM / FWTM 35.0° / 69.0°
 Efficiency 91 %
 Peak intensity 2 cd/lm
 LEDs/each optic 1
 Light colour White
 Required components:
 BJB: 47.319.2030

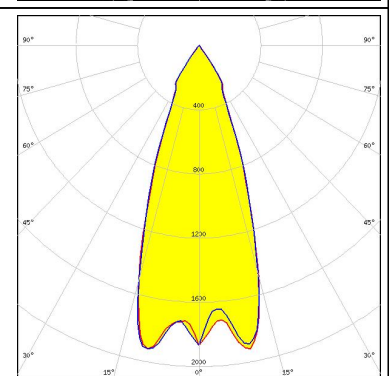

SAMSUNG

LED LC040D / LC060D / LC080D
 FWHM / FWTM 40.0° / 70.0°
 Efficiency 86 %
 Peak intensity 1.7 cd/lm
 LEDs/each optic 1
 Light colour White
 Required components:
 BJB: 47.319.2030

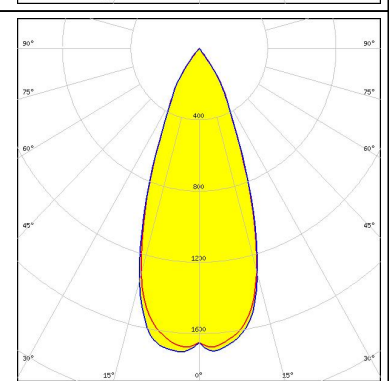

GENERAL INFORMATION:

NOTE: The typical beam angle will be changed by different color, chip size and chip position tolerance. The typical total beam angle is the full angle measured where the luminous intensity is half of the peak value.

Due to use of high power COB's with this product, special attention to proper thermal design is highly recommended. LEDiL has no liability for direct, indirect or consecutive damages arising from the LEDiL products being used outside of the recommended temperature range.

MATERIALS:

As part of our continuous research and improvement processes, and to ensure the best possible quality and availability of our products, LEDiL reserves the right to change material grades without notice.

PRODUCT DATA USER AGREEMENT AND DISCLAIMER:

The measured data in the provided downloadable LEDiL Product Datasheets and Mechanical 2D-Drawings is rounded and provided as reference for planning. LEDiL Oy's optical specifications have been verified by conducting performance testing of the products in accordance with the company's quality system. The reported data are averaged results of multiple measurements with typical variation. LEDiL Oy reserves the right to without prior notification make changes and improvements to its products.

LEDiL Oy assumes neither warranty, nor guarantee nor any other liability of any kind for the contents and correctness of the provided data. The provided data has been generated with highest diligence but the provided data may in reality not represent the complete possible variation range of all intrinsic parameters. Therefore, in certain cases a deviation from the provided data could occur.

LEDiL Oy reserves the right to undertake technical changes of its products without further notification which could lead to changes in the provided data. LEDiL Oy assumes no liability of any kind for the possible deviation from any provided data or any other damage resulting from the usage of the provided data.

The user agrees to this disclaimer and user agreement with the download or usage of the provided files.

LEDiL Oy

Joensuunkatu 13
FI-24240 SALO
Finland

LEDiL Inc.

228 West Page Street
Suite D
Sycamore IL 60178
USA

Ledil Optics Technology (Shenzhen) Co., Ltd.

405 , Block B
Casic Motor Building
Shenzhen 518057
P.R.CHINA

Local sales and technical support

[www.ledil.com/
where_to_buy](http://www.ledil.com/where_to_buy)

Shipping locations

Salo, Finland
Hong Kong, China

Distribution Partners

[www.ledil.com/
where_to_buy](http://www.ledil.com/where_to_buy)

X-ON Electronics

Largest Supplier of Electrical and Electronic Components

Click to view similar products for [LED Lighting Reflectors](#) category:

Click to view products by [Ledil](#) manufacturer:

Other Similar products are found below :

[LL04CR-CFN35155L02](#) [LL04CR-CFN60155L02](#) [LL04CR-CGM85135L02](#) [F13185_GERI-RZ](#) [10604](#) [LL01SP-ATH15R49](#) [10170](#) [12527](#)
[12531](#) [12568](#) [C13253_TINA2-R-CLIP16](#) [CA14591_BROOKE-XW](#) [F15560_MIRELLA-G2-W](#) [CA11525_LAURA-R-W](#) [12796](#) [LMH020-](#)
[REFL-0000-0000062](#) [LMH020-REFL-0000-0000082](#) [C12606_LENINA-DL](#) [CN12711_LENINA-W-DL](#) [C11394_TYRA-S](#) [C11396_TYRA-](#)
[W](#) [C11508_BROOKE-W](#) [C11552_BARBARA-S](#) [C11553_BARBARA-W](#) [C11862_MINNIE-W](#) [C11979_LENA-S](#) [C11980_LENA-W](#)
[C11996_LENA-LENS](#) [C12083_BROOKE-SCR-M](#) [C12095_MINNIE-M](#) [C12097_MINNIE-WWW](#) [C12154_LENA-M](#) [C12469_LISA2-R-](#)
[PIN](#) [C12476_MIRELLA-50-S](#) [C12477_MIRELLA-50-M](#) [C12480_MIRELLA-50-S-PIN](#) [C12516_RITA-WAS](#) [C12597_LENINA-S](#)
[C12599_LENINA-W](#) [C12948_LENA-WAS](#) [C12958_LENINA-XW](#) [C13085_MIRELLA-50-S-PF](#) [C13087_MIRELLA-50-W-PF](#)
[C13101_LENA-X-WAS](#) [C13555_BRIDGET-W-UNI](#) [C13556_BRIDGET-M-UNI](#) [C13557_BRIDGET-S-UNI](#) [C14346_ANGELETTE-WAS](#)
[C17099_ALISE-50-DL](#) [C17095_ALISE-70-CL](#)