

BARBARA-XW-PF

White version with ~75° wide beam

TECHNICAL SPECIFICATIONS:

Dimensions	Ø 70.0 mm
Height	41.7 mm
Fastening	socket
ROHS compliant	yes ⓘ

MATERIAL SPECIFICATIONS:

Component	Type	Material	Colour	Finish	Coating
BARBARA-XW-PF	Reflector	HRPC	white		

ORDERING INFORMATION:



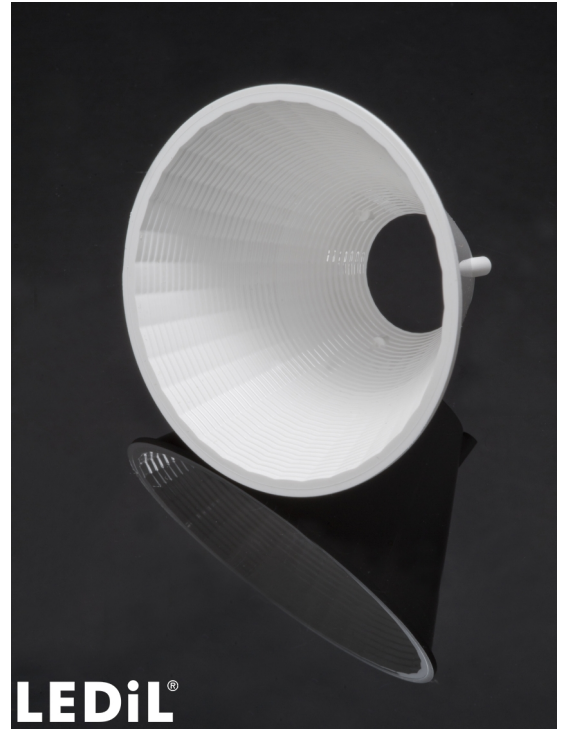

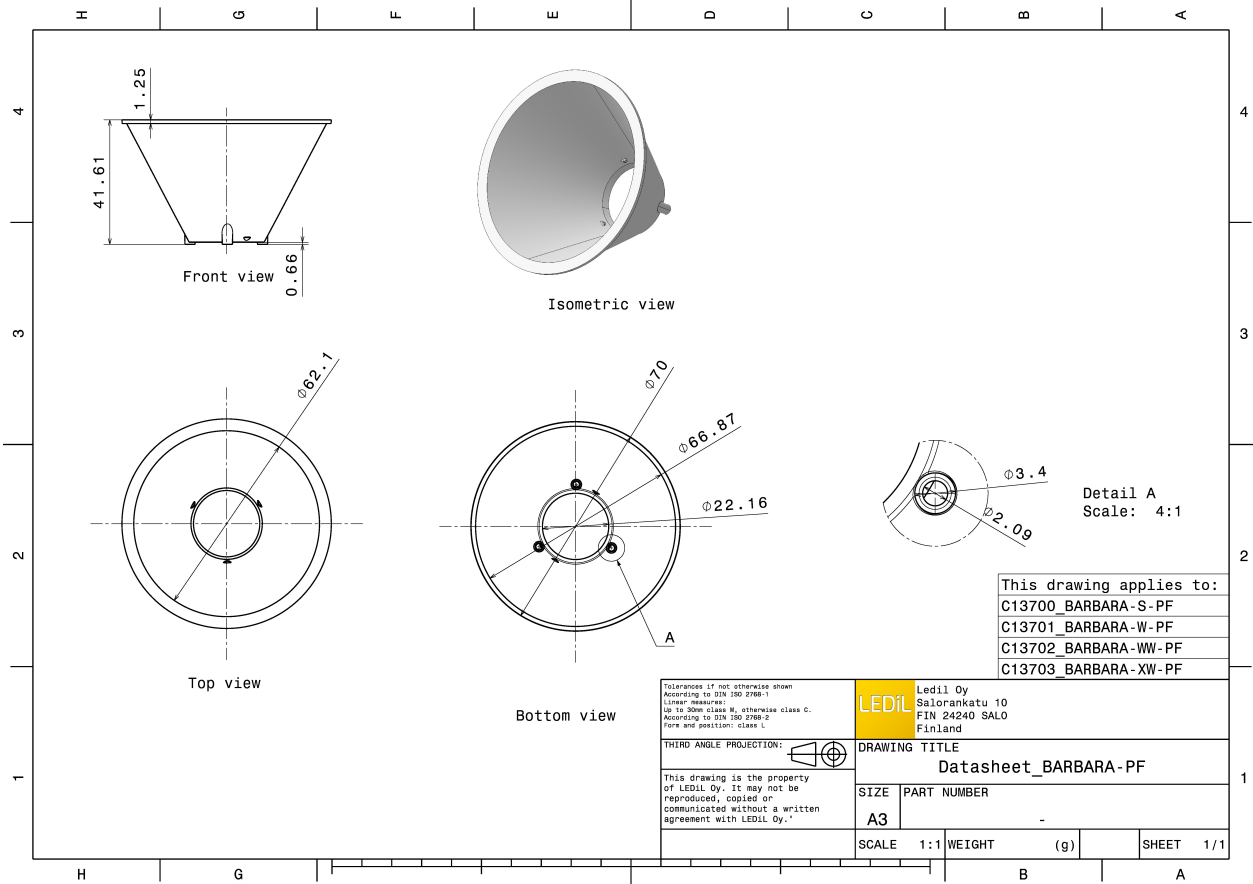



Component	Qty in box	MOQ	MPQ	Box weight (kg)
F13703_BARBARA-XW-PF » Box size: 480 x 280 x 300 mm	288	90	18	8.4

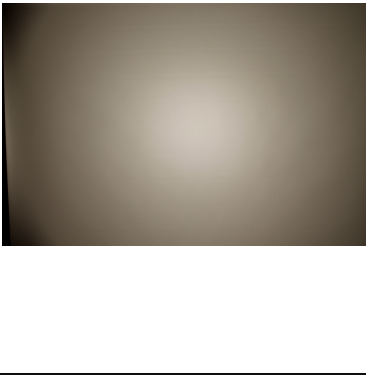
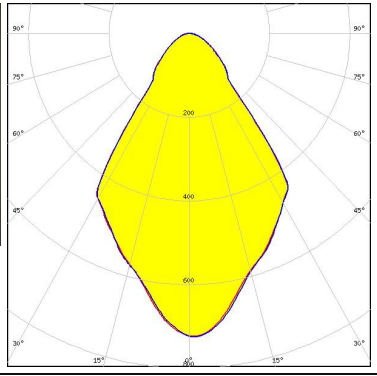

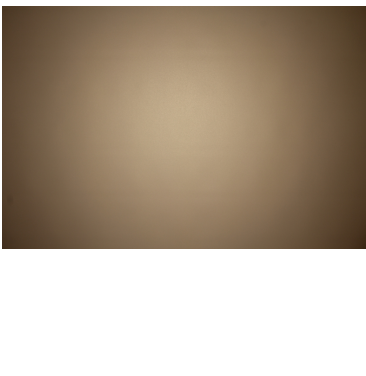



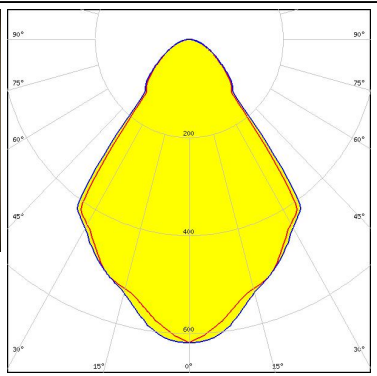

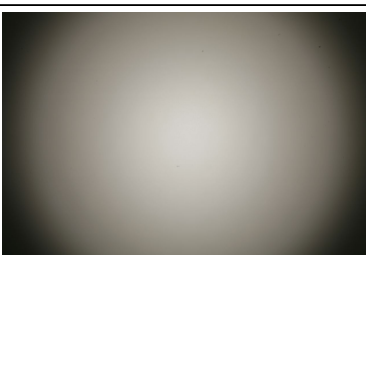
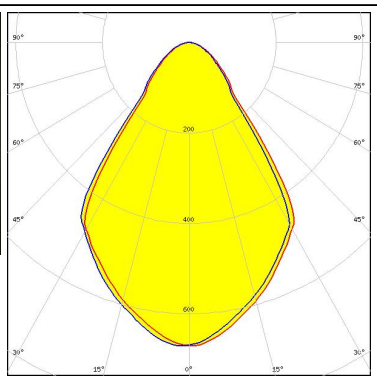
See also our general installation guide: www.ledil.com/installation_guide

PHOTOMETRIC DATA (MEASURED):

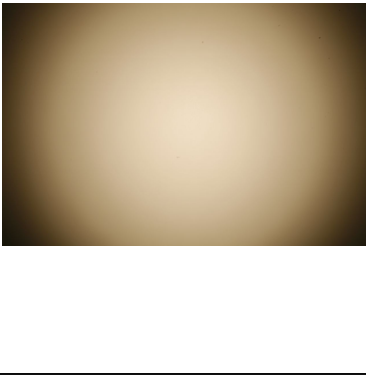
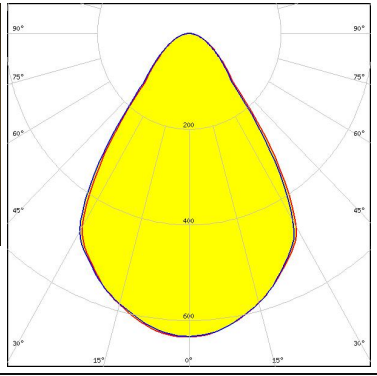
<p></p> <p>LED V10 Gen7 FWHM / FWTM 70.0° / 111.0° Efficiency 90 % Peak intensity 0.7 cd/lm LEDs/each optic 1 Light colour White Required components: C13709_PF-SOCKET-VERO13-18 Bender Wirth: 434 Typ L1</p>		
<p></p> <p>LED V15 Gen6 FWHM / FWTM 71.0° / 116.0° Efficiency 89 % Peak intensity 0.7 cd/lm LEDs/each optic 1 Light colour White Required components: C13709_PF-SOCKET-VERO13-18 Bender Wirth: 456 Typ L2</p>		
<p></p> <p>LED V8 Gen6 FWHM / FWTM 74.0° / 119.0° Efficiency 90 % Peak intensity 0.6 cd/lm LEDs/each optic 1 Light colour White Required components: C13761_PF-SOCKET-CXA15</p>		
<p></p> <p>LED VERO13 FWHM / FWTM 72.0° / 116.0° Efficiency 93 % Peak intensity 0.7 cd/lm LEDs/each optic 1 Light colour White Required components: C13709_PF-SOCKET-VERO13-18</p>		

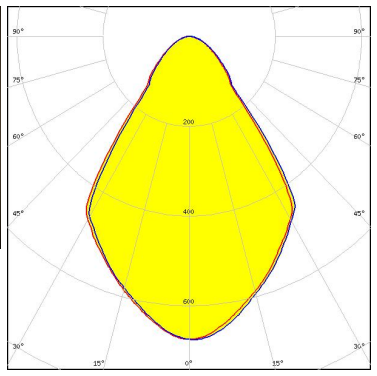
PHOTOMETRIC DATA (MEASURED):

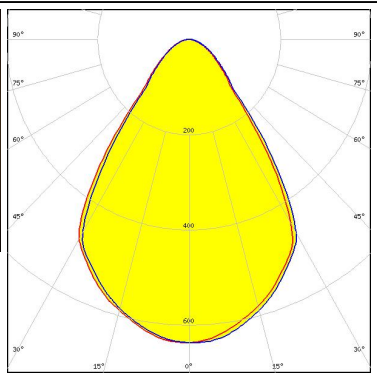
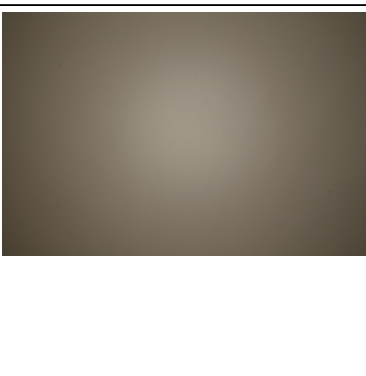
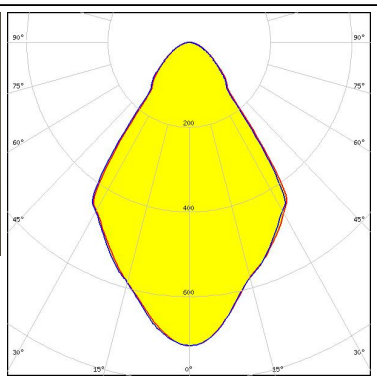
<p></p> <p>LED VERO18 FWHM / FWTM 72.0° / 116.0° Efficiency 93 % Peak intensity 0.6 cd/lm LEDs/each optic 1 Light colour White Required components: C13709_PF-SOCKET-VERO13-18</p>		
<p></p> <p>LED Xenio Point 13mm FWHM / FWTM 71.0° / 114.0° Efficiency 92 % Peak intensity 0.7 cd/lm LEDs/each optic 1 Light colour White Required components: C13709_PF-SOCKET-VERO13-18</p>		
<p></p> <p>LED Xenio Point 18mm FWHM / FWTM 72.0° / 115.0° Efficiency 91 % Peak intensity 0.6 cd/lm LEDs/each optic 1 Light colour White Required components: C13709_PF-SOCKET-VERO13-18</p>		
<p>CITIZEN</p> <p>LED CLL02x/CLU02x (LES10) FWHM / FWTM 70.0° / 111.0° Efficiency 90 % Peak intensity 0.7 cd/lm LEDs/each optic 1 Light colour White Required components: C13709_PF-SOCKET-VERO13-18 Bender Wirth: 434 Typ L1</p>		

PHOTOMETRIC DATA (MEASURED):

CITIZEN

LED CLU700/701/702
 FWHM / FWTM 70.0° / 109.0°
 Efficiency 90 %
 Peak intensity 0.8 cd/m
 LEDs/each optic 1
 Light colour White
 Required components:
 C13709_PF-SOCKET-VERO13-18
 Bender Wirth: 434 Typ L1

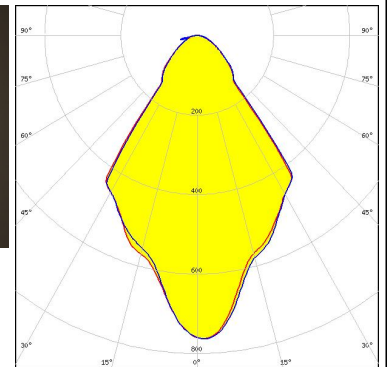
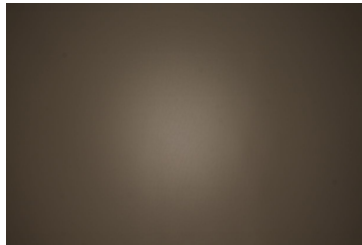

CREE LED

LED CXA/B 15xx
 FWHM / FWTM 70.0° / 111.0°
 Efficiency 90 %
 Peak intensity 0.7 cd/m
 LEDs/each optic 1
 Light colour White
 Required components:
 C13709_PF-SOCKET-VERO13-18
 Bender Wirth: 441 Typ L1

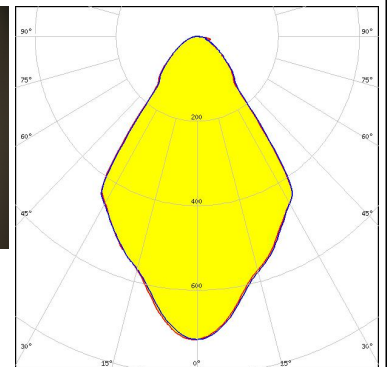
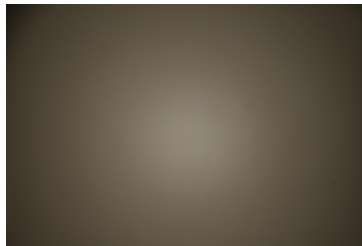

CREE LED

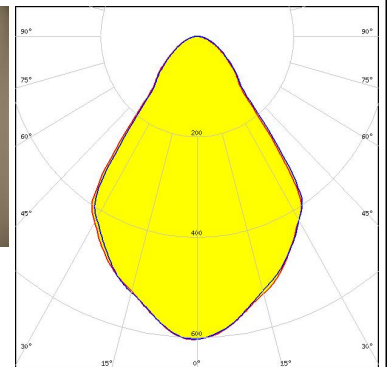
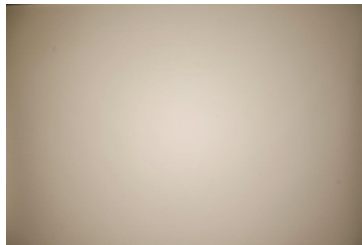

LED CXA/B 15xx
 FWHM / FWTM 73.0° / 117.0°
 Efficiency 85 %
 Peak intensity 0.6 cd/m
 LEDs/each optic 1
 Light colour White
 Required components:
 C13083_PF-SOCKET
 C14658_BARBARA-RZ-LENS





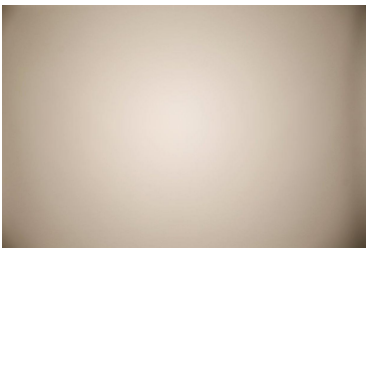
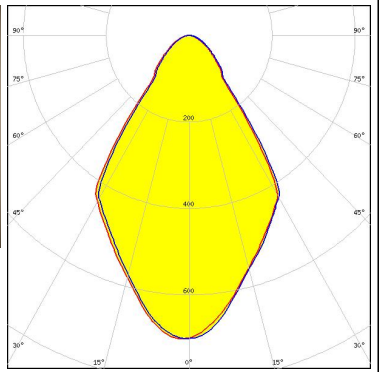

CREE LED

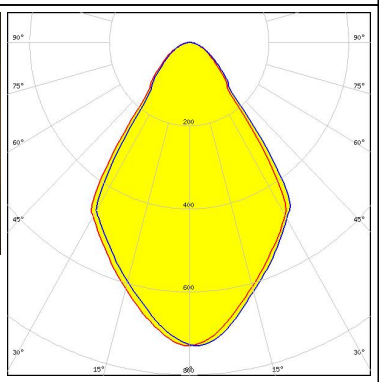
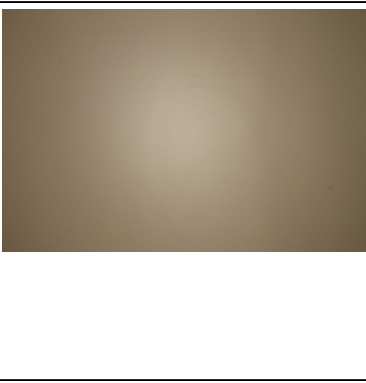
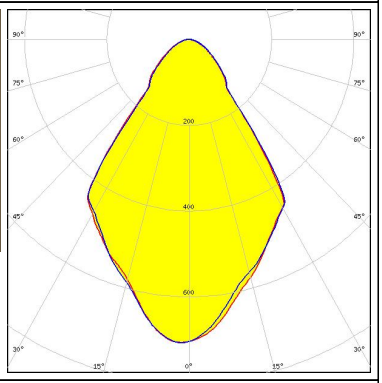
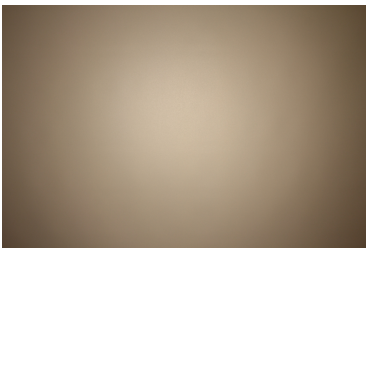
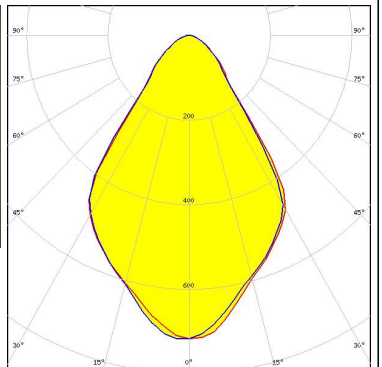
LED CXA/B 15xx
 FWHM / FWTM 70.0° / 110.0°
 Efficiency 92 %
 Peak intensity 0.8 cd/m
 LEDs/each optic 1
 Light colour White
 Required components:
 C14115_PF-SOCKET-CXA15-18



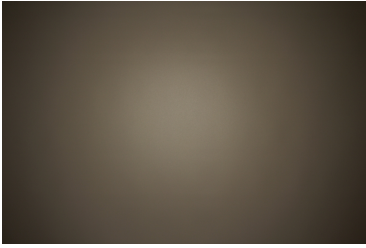

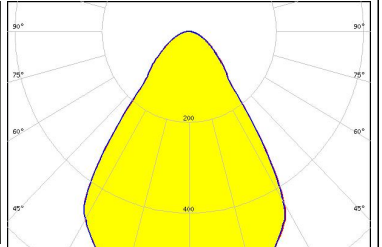
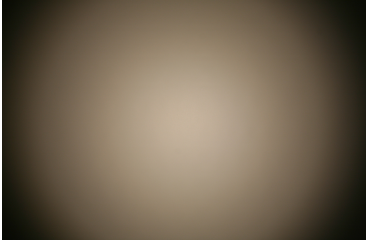
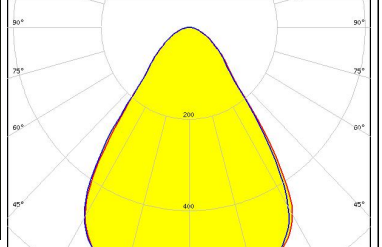
PHOTOMETRIC DATA (MEASURED):

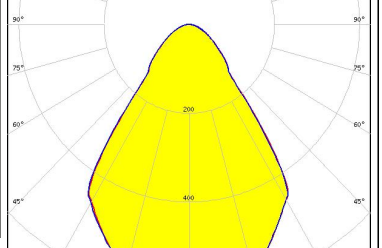
<p>CREE LED</p> <p>LED CXA/B 1816 & CXA/B 1820 & CXA 1850 FWHM / FWTM 67.0° / 106.0° Efficiency 82 % Peak intensity 0.7 cd/lm LEDs/each optic 1 Light colour White</p> <p>Required components: C13709_PF-SOCKET-VERO13-18 Bender Wirth: 437 Typ L1</p>		
<p>CREE LED</p> <p>LED CXA/B 1816 & CXA/B 1820 & CXA 1850 FWHM / FWTM 70.0° / 112.0° Efficiency 93 % Peak intensity 0.7 cd/lm LEDs/each optic 1 Light colour White</p> <p>Required components: C14115_PF-SOCKET-CXA15-18</p>		
<p>LUMILEDS</p> <p>LED LUXEON CoB 1202/1203 FWHM / FWTM 71.0° / 112.0° Efficiency 90 % Peak intensity 0.7 cd/lm LEDs/each optic 1 Light colour White</p> <p>Required components: C13709_PF-SOCKET-VERO13-18 Bender Wirth: 438 Typ L1</p>		
<p>LUMILEDS</p> <p>LED LUXEON CoB 1202/1203 FWHM / FWTM 71.0° / 112.0° Efficiency 92 % Peak intensity 0.7 cd/lm LEDs/each optic 1 Light colour White</p> <p>Required components: C14037_PF-NSX-SOCKET</p>		

PHOTOMETRIC DATA (MEASURED):

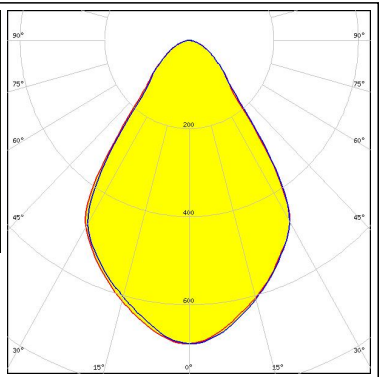
<p>LUMILEDS</p> <p>LED LUXEON CoB 1202s</p> <p>FWHM / FWTM 75.0° / 120.0°</p> <p>Efficiency 92 %</p> <p>Peak intensity 0.7 cd/m</p> <p>LEDs/each optic 1</p> <p>Light colour White</p> <p>Required components: C13761_PF-SOCKET-CXA15</p>		
<p>NICHIA</p> <p>LED COB J-Type</p> <p>FWHM / FWTM 70.0° / 112.0°</p> <p>Efficiency 89 %</p> <p>Peak intensity 0.7 cd/m</p> <p>LEDs/each optic 1</p> <p>Light colour White</p> <p>Required components: C13709_PF-SOCKET-VERO13-18 Bender Wirth: 463 Typ L2</p>		
<p>NICHIA</p> <p>LED COB J-Type</p> <p>FWHM / FWTM 72.0° / 116.0°</p> <p>Efficiency 93 %</p> <p>Peak intensity 0.7 cd/m</p> <p>LEDs/each optic 1</p> <p>Light colour White</p> <p>Required components: C14037_PF-NSX-SOCKET</p>		
<p>NICHIA</p> <p>LED COB L-Type (LES 11)</p> <p>FWHM / FWTM 70.0° / 113.0°</p> <p>Efficiency 90 %</p> <p>Peak intensity 0.7 cd/m</p> <p>LEDs/each optic 1</p> <p>Light colour White</p> <p>Required components: C13709_PF-SOCKET-VERO13-18 Bender Wirth: 438 Typ L1</p>		

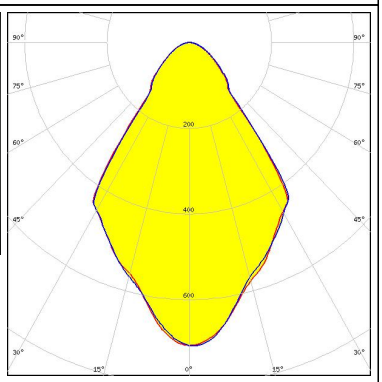
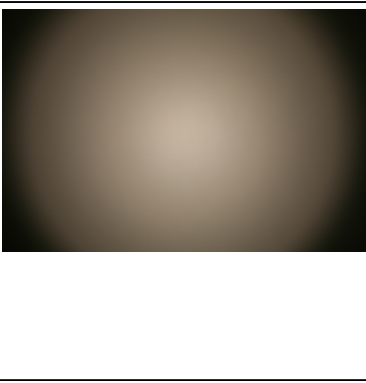
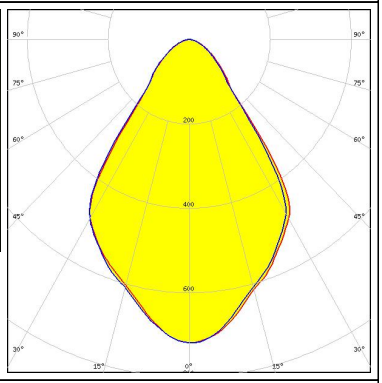
PHOTOMETRIC DATA (MEASURED):

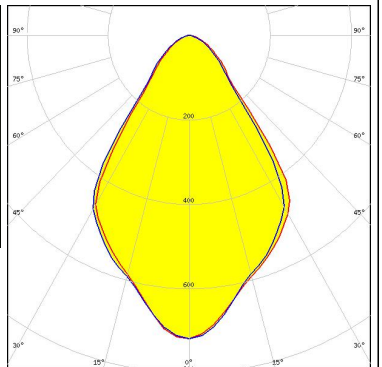
<p>NICHIA</p> <p>LED COB L-Type (LES 11)</p> <p>FWHM / FWTM 72.0° / 115.0°</p> <p>Efficiency 93 %</p> <p>Peak intensity 0.7 cd/m</p> <p>LEDs/each optic 1</p> <p>Light colour White</p> <p>Required components: C14037_PF-NSX-SOCKET</p>		
<p>NICHIA</p> <p>LED COB L-Type (LES 9)</p> <p>FWHM / FWTM 70.0° / 112.0°</p> <p>Efficiency 90 %</p> <p>Peak intensity 0.7 cd/m</p> <p>LEDs/each optic 1</p> <p>Light colour White</p> <p>Required components: C13709_PF-SOCKET-VERO13-18 Bender Wirth: 438 Typ L1</p>		
<p>NICHIA</p> <p>LED COB L-Type (LES 9)</p> <p>FWHM / FWTM 72.0° / 112.0°</p> <p>Efficiency 93 %</p> <p>Peak intensity 0.7 cd/m</p> <p>LEDs/each optic 1</p> <p>Light colour White</p> <p>Required components: C14037_PF-NSX-SOCKET</p>		
<p>NICHIA</p> <p>LED NSCxL036A</p> <p>FWHM / FWTM 71.0° / 112.0°</p> <p>Efficiency 91 %</p> <p>Peak intensity 0.7 cd/m</p> <p>LEDs/each optic 1</p> <p>Light colour White</p> <p>Required components: C14037_PF-NSX-SOCKET</p>		

PHOTOMETRIC DATA (MEASURED):

OSRAM

Opto Semiconductors

LED OSTAR Stage (S2WP)
 FWHM / FWTM 74.0° / 120.0°
 Efficiency 83 %
 Peak intensity 0.6 cd/lm
 LEDs/each optic 1
 Light colour White
 Required components:
 C13083_PF-SOCKET
 C14658_BARBARA-RZ-LENS

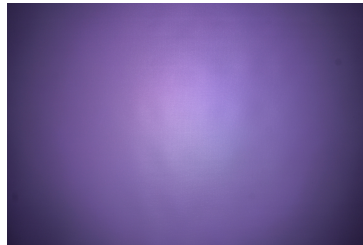

OSRAM

Opto Semiconductors

LED Soleriq S13
 FWHM / FWTM 70.0° / 113.0°
 Efficiency 90 %
 Peak intensity 0.7 cd/lm
 LEDs/each optic 1
 Light colour White
 Required components:
 C13709_PF-SOCKET-VERO13-18
 Bender Wirth: 437 Typ L1

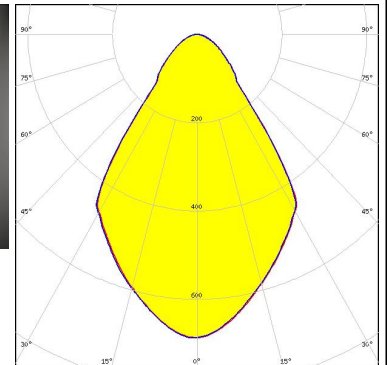
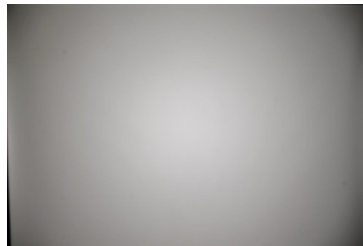

SAMSUNG

LED LC026B / 033B / 040B
 FWHM / FWTM 70.0° / 113.0°
 Efficiency 90 %
 Peak intensity 0.6 cd/lm
 LEDs/each optic 1
 Light colour White
 Required components:
 C13709_PF-SOCKET-VERO13-18
 Bender Wirth: 450 Typ L2

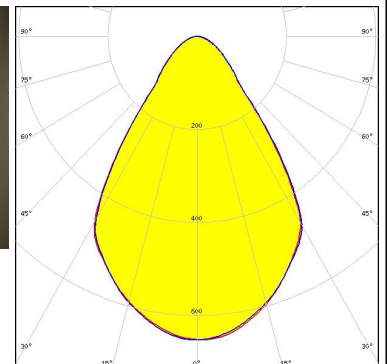
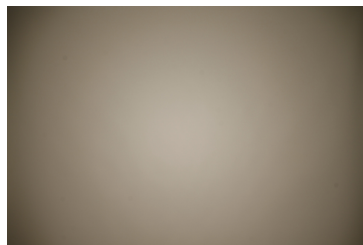

XICATO

LED XTM - 19mm LES
 FWHM / FWTM 70.0° / 112.0°
 Efficiency 83 %
 Peak intensity 0.6 cd/lm
 LEDs/each optic 1
 Light colour White
 Required components:
 C14636_XTM-PF-ADAPTER

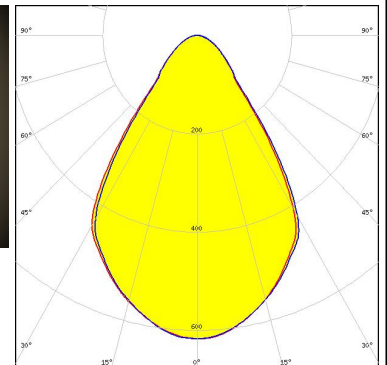
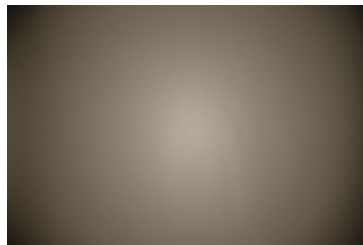

PHOTOMETRIC DATA (MEASURED):

XICATO

LED XTM - 9mm LES
FWHM / FWTM 70.0° / 111.0°
Efficiency 86 %
Peak intensity 0.7 cd/lm
LEDs/each optic 1
Light colour White
Required components:
C14636_XTM-PF-ADAPTER

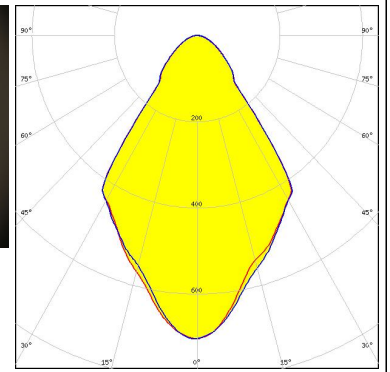

PHOTOMETRIC DATA (SIMULATED):

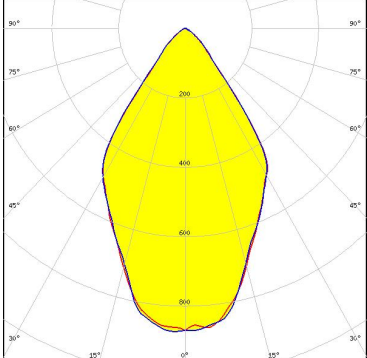
<p>bridgelux</p> <p>LED: V10 Gen7 FWHM / FWTM: 66.0° / 93.0° Efficiency: 88 % Peak intensity: 0.9 cd/lm LEDs/each optic: 1 Light colour: White</p> <p>Required components: C13709_PF-SOCKET-VERO13-18 Bender Wirth: 486 Typ L1</p>	
<p>LUMILEDS</p> <p>LED: LUXEON CoB Compact FWHM / FWTM: 75.0° / 120.0° Efficiency: 92 % Peak intensity: 0.7 cd/lm LEDs/each optic: 1 Light colour: White</p> <p>Required components: C13761_PF-SOCKET-CXA15</p>	
<p>LUMINUS</p> <p>LED: CxM-14 (19x19) FWHM / FWTM: 70.0° / 113.0° Efficiency: 90 % Peak intensity: 0.7 cd/lm LEDs/each optic: 1 Light colour: White</p> <p>Required components: C13709_PF-SOCKET-VERO13-18 Bender Wirth: 433 Typ L1</p>	
<p>LUMINUS</p> <p>LED: CxM-9 (13.5x13.5) FWHM / FWTM: 70.0° / 111.0° Efficiency: 90 % Peak intensity: 0.7 cd/lm LEDs/each optic: 1 Light colour: White</p> <p>Required components: C13709_PF-SOCKET-VERO13-18 Bender Wirth: 434 Typ L1</p>	

PHOTOMETRIC DATA (SIMULATED):

OSRAM

Opto Semiconductors

LED Soleriq S15
 FWHM / FWTM 74.0° / 112.0°
 Efficiency 95 %
 Peak intensity 0.7 cd/lm
 LEDs/each optic 1
 Light colour White
 Required components:
 C13709_PF-SOCKET-VERO13-18
 Bender Wirth: 433 Typ L1

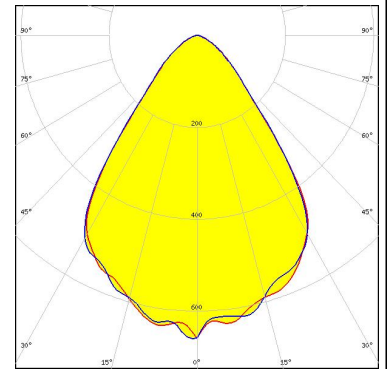

SAMSUNG

LED LC010C
 FWHM / FWTM 66.0° / 91.0°
 Efficiency 89 %
 Peak intensity 0.9 cd/lm
 LEDs/each optic 1
 Light colour White
 Required components:
 C13709_PF-SOCKET-VERO13-18
 Bender Wirth: 479 Typ L1

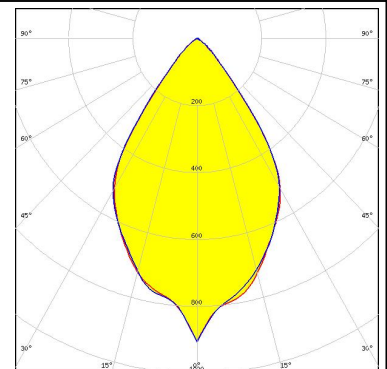

SAMSUNG

LED LC020C
 FWHM / FWTM 70.0° / 95.0°
 Efficiency 88 %
 Peak intensity 0.8 cd/lm
 LEDs/each optic 1
 Light colour White
 Required components:
 C13709_PF-SOCKET-VERO13-18
 Bender Wirth: 479 Typ L1

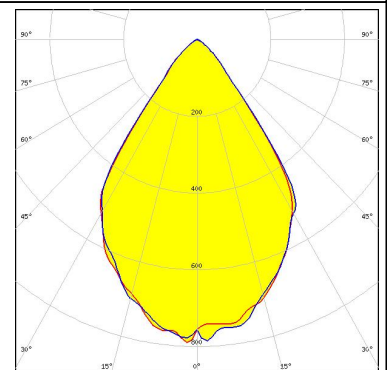

SAMSUNG

LED LC040C
 FWHM / FWTM 70.0° / 96.0°
 Efficiency 84 %
 Peak intensity 0.7 cd/lm
 LEDs/each optic 1
 Light colour White
 Required components:
 C13709_PF-SOCKET-VERO13-18
 Bender Wirth: 480 Typ L1

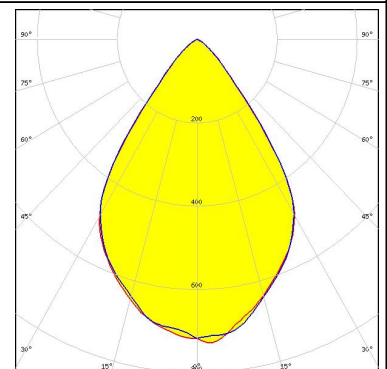

PHOTOMETRIC DATA (SIMULATED):

	
SEOL SEMICONDUCTOR	
LED	ZC12/18
FWHM / FWTM	70.0° / 113.0°
Efficiency	90 %
Peak intensity	0.7 cd/lm
LEDs/each optic	1
Light colour	White
Required components:	
C13709_PF-SOCKET-VERO13-18	
Bender Wirth: 433 Typ L1	
<hr/>	
	
SEOL SEMICONDUCTOR	
LED	ZC4/6
FWHM / FWTM	70.0° / 111.0°
Efficiency	90 %
Peak intensity	0.7 cd/lm
LEDs/each optic	1
Light colour	White
Required components:	
C13709_PF-SOCKET-VERO13-18	
Bender Wirth: 434 Typ L1	

GENERAL INFORMATION:

NOTE: The typical beam angle will be changed by different color, chip size and chip position tolerance. The typical total beam angle is the full angle measured where the luminous intensity is half of the peak value.

Due to use of high power COB's with this product, special attention to proper thermal design is highly recommended. LEDiL has no liability for direct, indirect or consecutive damages arising from the LEDiL products being used outside of the recommended temperature range.

MATERIALS:

As part of our continuous research and improvement processes, and to ensure the best possible quality and availability of our products, LEDiL reserves the right to change material grades without notice.

PRODUCT DATA USER AGREEMENT AND DISCLAIMER:

The measured data in the provided downloadable LEDiL Product Datasheets and Mechanical 2D-Drawings is rounded and provided as reference for planning. LEDiL Oy's optical specifications have been verified by conducting performance testing of the products in accordance with the company's quality system. The reported data are averaged results of multiple measurements with typical variation. LEDiL Oy reserves the right to without prior notification make changes and improvements to its products.

LEDiL Oy assumes neither warranty, nor guarantee nor any other liability of any kind for the contents and correctness of the provided data. The provided data has been generated with highest diligence but the provided data may in reality not represent the complete possible variation range of all intrinsic parameters. Therefore, in certain cases a deviation from the provided data could occur.

LEDiL Oy reserves the right to undertake technical changes of its products without further notification which could lead to changes in the provided data. LEDiL Oy assumes no liability of any kind for the possible deviation from any provided data or any other damage resulting from the usage of the provided data.

The user agrees to this disclaimer and user agreement with the download or usage of the provided files.

LEDiL Oy

Joensuunkatu 13
FI-24240 SALO
Finland

LEDiL Inc.

228 West Page Street
Suite D
Sycamore IL 60178
USA

Ledil Optics Technology (Shenzhen) Co., Ltd.

405 , Block B
Casic Motor Building
Shenzhen 518057
P.R.CHINA

Local sales and technical support

[www.ledil.com/
where_to_buy](http://www.ledil.com/where_to_buy)

Shipping locations

Salo, Finland
Hong Kong, China

Distribution Partners

[www.ledil.com/
where_to_buy](http://www.ledil.com/where_to_buy)

X-ON Electronics

Largest Supplier of Electrical and Electronic Components

Click to view similar products for [LED Lighting Reflectors](#) category:

Click to view products by [Ledil](#) manufacturer:

Other Similar products are found below :

[LL04CR-CFN35155L02](#) [LL04CR-CFN60155L02](#) [LL04CR-CGM85135L02](#) [F13185_GERI-RZ](#) [10604](#) [LL01SP-ATH15R49](#) [10170](#) [12527](#)
[12531](#) [12568](#) [C13253_TINA2-R-CLIP16](#) [CA14591_BROOKE-XW](#) [F15560_MIRELLA-G2-W](#) [CA11525_LAURA-R-W](#) [12796](#) [LMH020-](#)
[REFL-0000-0000062](#) [LMH020-REFL-0000-0000082](#) [C12606_LENINA-DL](#) [CN12711_LENINA-W-DL](#) [C11394_TYRA-S](#) [C11396_TYRA-](#)
[W](#) [C11508_BROOKE-W](#) [C11552_BARBARA-S](#) [C11553_BARBARA-W](#) [C11862_MINNIE-W](#) [C11979_LENA-S](#) [C11980_LENA-W](#)
[C11996_LENA-LENS](#) [C12083_BROOKE-SCR-M](#) [C12095_MINNIE-M](#) [C12097_MINNIE-WWW](#) [C12154_LENA-M](#) [C12469_LISA2-R-](#)
[PIN](#) [C12476_MIRELLA-50-S](#) [C12477_MIRELLA-50-M](#) [C12480_MIRELLA-50-S-PIN](#) [C12516_RITA-WAS](#) [C12597_LENINA-S](#)
[C12599_LENINA-W](#) [C12948_LENA-WAS](#) [C12958_LENINA-XW](#) [C13085_MIRELLA-50-S-PF](#) [C13087_MIRELLA-50-W-PF](#)
[C13101_LENA-X-WAS](#) [C13555_BRIDGET-W-UNI](#) [C13556_BRIDGET-M-UNI](#) [C13557_BRIDGET-S-UNI](#) [C14346_ANGELETTE-WAS](#)
[C17099_ALISE-50-DL](#) [C17095_ALISE-70-CL](#)