

## FLORENCE-1R-Z90

~90° + 110° wide beam

### TECHNICAL SPECIFICATIONS:

Dimensions	19.5 x 286.0 mm
Height	7 mm
Fastening	clips
ROHS compliant	yes ⓘ

### MATERIAL SPECIFICATIONS:

Component	Type	Material	Colour	Finish
FLORENCE-1R-Z90	Linear lens	PMMA	clear	



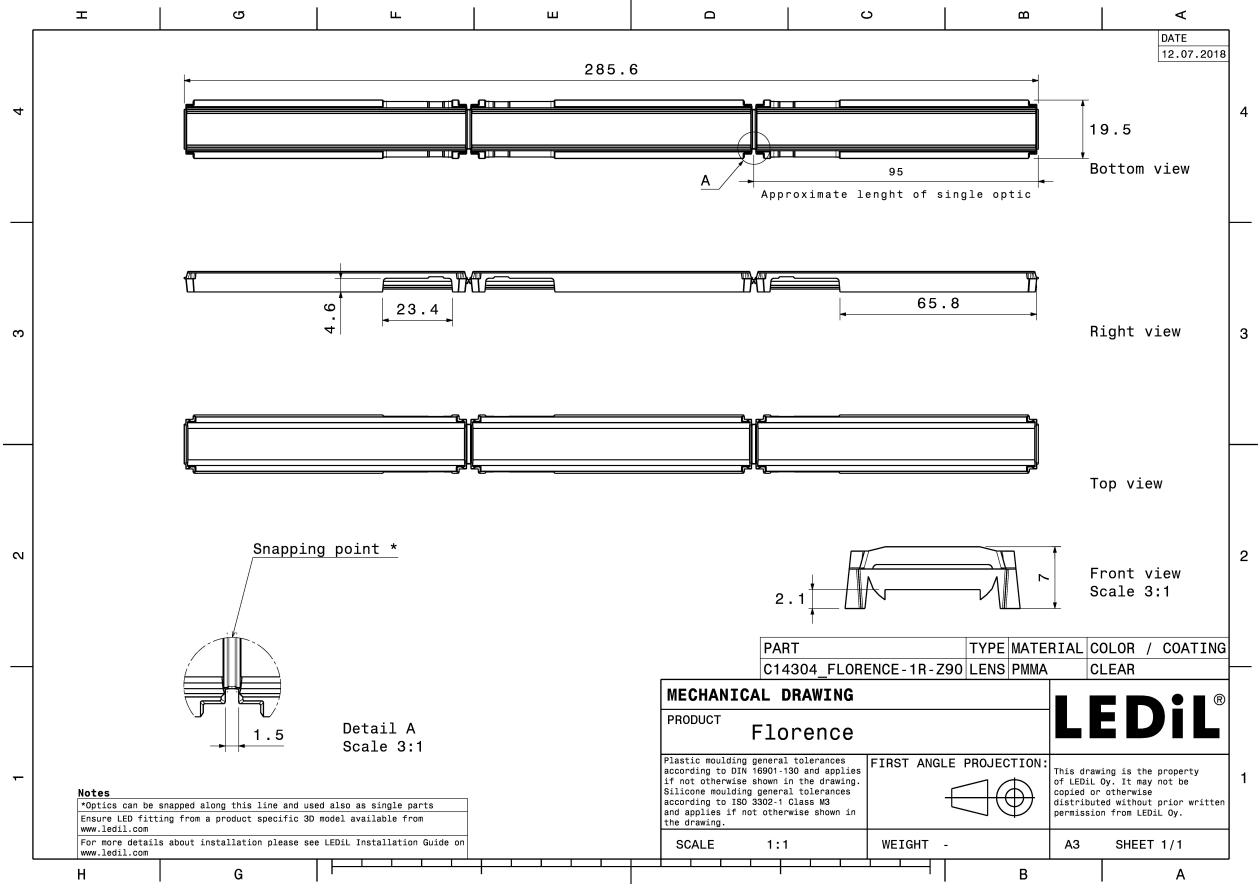

### ORDERING INFORMATION:

Component	Qty in box	MOQ	MPQ	Box weight (kg)
F14304_FLORENCE-1R-Z90 » Box size: 398 x 298 x 265 mm	165	45	15	7.5

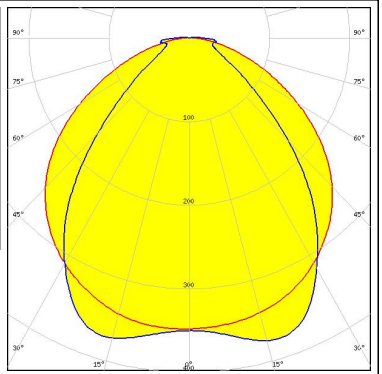

See also our general installation guide: [www.ledil.com/installation\\_guide](http://www.ledil.com/installation_guide)

#### PHOTOMETRIC DATA (MEASURED):

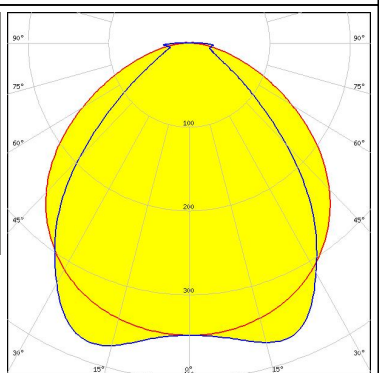
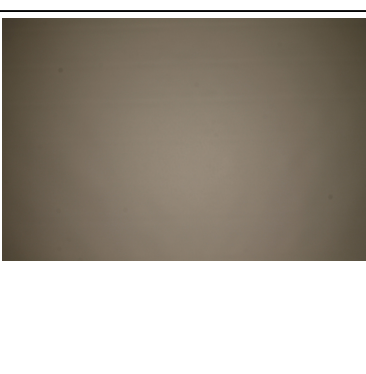
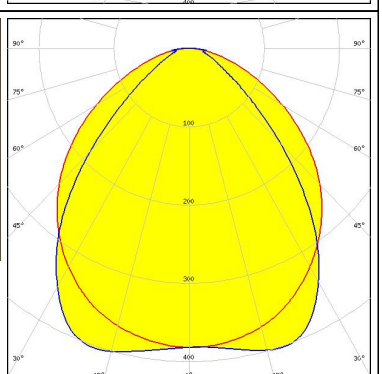
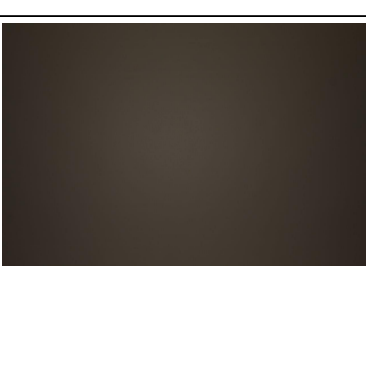
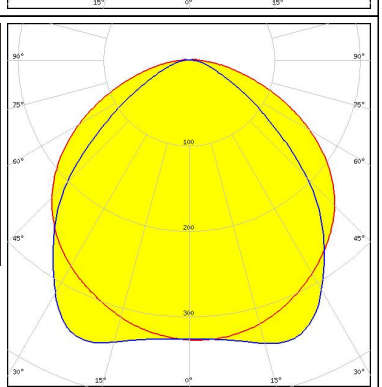
<p><b>aled</b></p> <p>LED CALGD0414-M8W1</p> <p>FWHM / FWTM 89.0 + 115.0° / 151.0 + 159.0°</p> <p>Efficiency 93 %</p> <p>Peak intensity 0.4 cd/lm</p> <p>LEDs/each optic 1</p> <p>Light colour White</p> <p>Required components:</p>		
<p><b>aled</b></p> <p>LED CALGD0814-M17W1</p> <p>FWHM / FWTM 90.0 + 114.0° / 137.0 + 159.0°</p> <p>Efficiency 93 %</p> <p>Peak intensity 0.4 cd/lm</p> <p>LEDs/each optic 1</p> <p>Light colour White</p> <p>Required components:</p>		
<p><b>CEZOS</b></p> <p>LED L0-280024-xxx-C0800-L267</p> <p>FWHM / FWTM 88.0 + 106.0° / 131.0 + 156.0°</p> <p>Efficiency 92 %</p> <p>Peak intensity 0.4 cd/lm</p> <p>LEDs/each optic 1</p> <p>Light colour White</p> <p>Required components:</p>		
<p><b>CREE LED</b></p> <p>LED XH-B/G</p> <p>FWHM / FWTM 97.0 + 117.0° / 139.0 + 165.0°</p> <p>Efficiency 90 %</p> <p>Peak intensity 0.4 cd/lm</p> <p>LEDs/each optic 1</p> <p>Light colour White</p> <p>Required components:</p>		

#### PHOTOMETRIC DATA (MEASURED):

##### LUMILEDS

LED LUXEON 3014  
 FWHM / FWTM 91.0 + 109.0° / 125.0 + 156.0°  
 Efficiency 94 %  
 Peak intensity 0.4 cd/lm  
 LEDs/each optic 1  
 Light colour White  
 Required components:

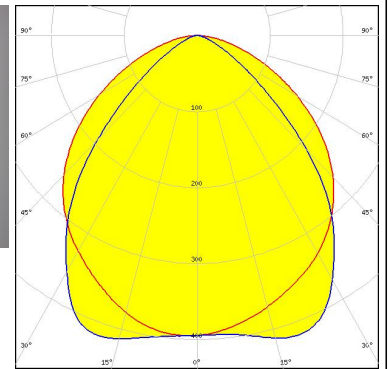

##### LUMILEDS

LED LUXEON 3020  
 FWHM / FWTM 89.0 + 108.0° / 123.0 + 157.0°  
 Efficiency 94 %  
 Peak intensity 0.4 cd/lm  
 LEDs/each optic 1  
 Light colour White  
 Required components:

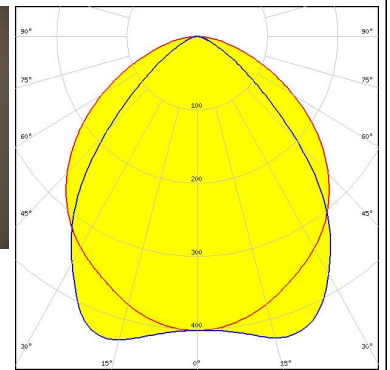
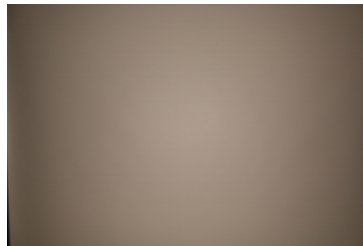

##### LUMILEDS

LED LUXEON 3030 2D (Round LES)  
 FWHM / FWTM 88.0 + 108.0° / 125.0 + 157.0°  
 Efficiency 92 %  
 Peak intensity 0.4 cd/lm  
 LEDs/each optic 1  
 Light colour White  
 Required components:

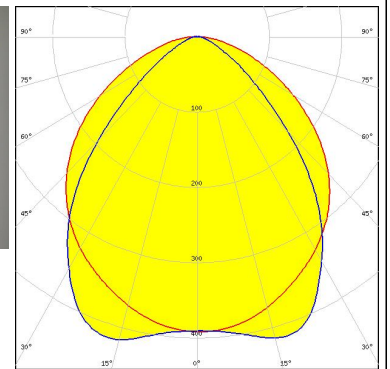
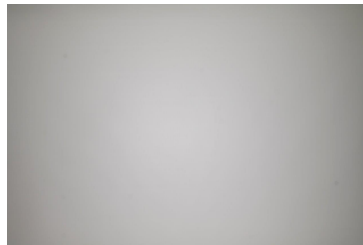

##### LUMILEDS

LED LUXEON 3535 2D  
 FWHM / FWTM 92.0 + 110.0° / 133.0 + 160.0°  
 Efficiency 93 %  
 Peak intensity 0.4 cd/lm  
 LEDs/each optic 1  
 Light colour White  
 Required components:

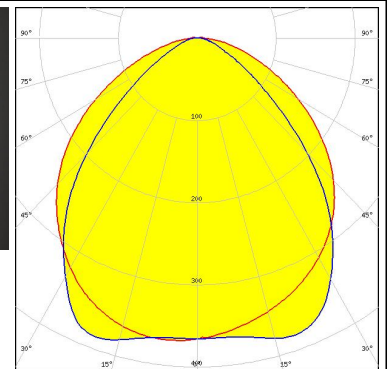
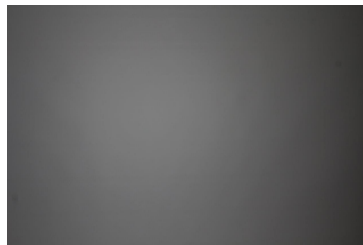

#### PHOTOMETRIC DATA (MEASURED):

#### LUMILEDS

LED LUXEON 3535L  
 FWHM / FWTM 92.0 + 109.0° / 128.0 + 157.0°  
 Efficiency 94 %  
 Peak intensity 0.4 cd/lm  
 LEDs/each optic 1  
 Light colour White  
 Required components:

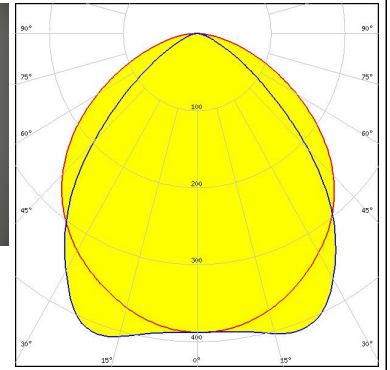

#### LUMINUS

LED MP-2016  
 FWHM / FWTM 89.0 + 108.0° / 125.0 + 157.0°  
 Efficiency 93 %  
 Peak intensity 0.4 cd/lm  
 LEDs/each optic 1  
 Light colour White  
 Required components:

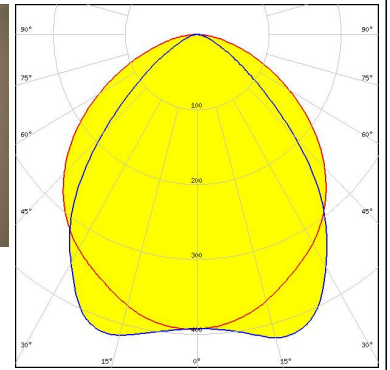
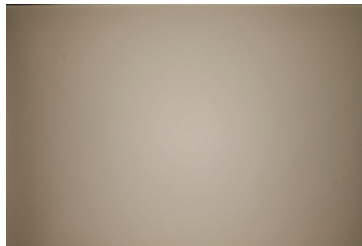

#### NICHIA

LED NF2x757D  
 FWHM / FWTM 90.0 + 110.0° / 131.0 + 160.0°  
 Efficiency 93 %  
 Peak intensity 0.4 cd/lm  
 LEDs/each optic 1  
 Light colour White  
 Required components:

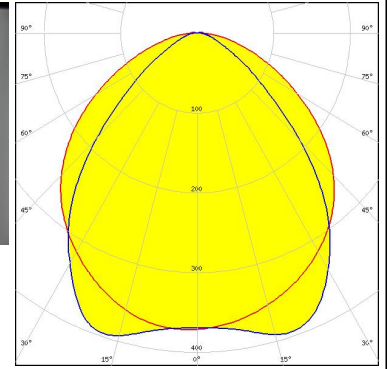

#### NICHIA

LED NF2x757G  
 FWHM / FWTM 90.0 + 108.0° / 127.0 + 158.0°  
 Efficiency 92 %  
 Peak intensity 0.4 cd/lm  
 LEDs/each optic 1  
 Light colour White  
 Required components:

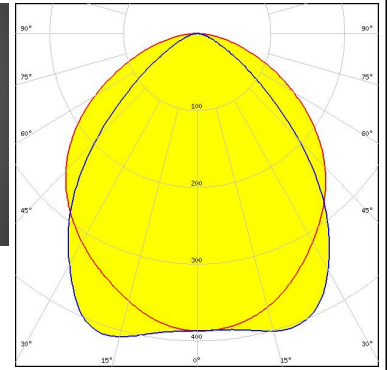
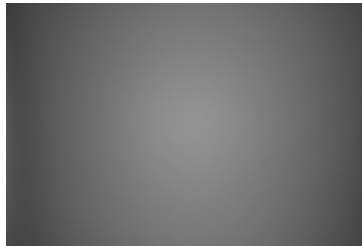

#### PHOTOMETRIC DATA (MEASURED):



**LED** NFSW757H  
**FWHM / FWTM** 104.0 + 89.0° / 156.0 + 140.0°  
**Efficiency** 94 %  
**Peak intensity** 0.4 cd/lm  
**LEDs/each optic** 1  
**Light colour** White  
**Required components:**  
 C14353\_FLORENCE-1R-CLIP-A

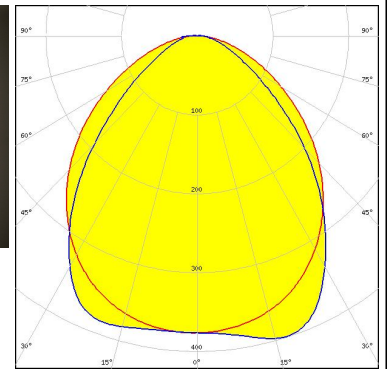
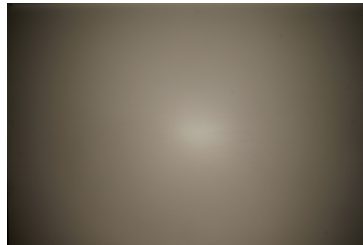

**LED** Duris S5 (2 chip)  
**FWHM / FWTM** 90.0 + 113.0° / 131.0 + 161.0°  
**Efficiency** 94 %  
**Peak intensity** 0.4 cd/lm  
**LEDs/each optic** 1  
**Light colour** White  
**Required components:**

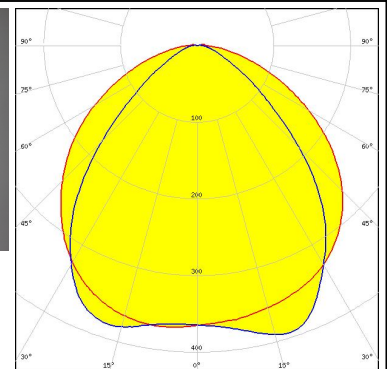
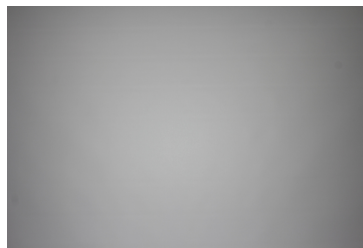

**LED** LM28xB Series  
**FWHM / FWTM** 91.0 + 111.0° / 127.0 + 158.0°  
**Efficiency** 94 %  
**Peak intensity** 0.4 cd/lm  
**LEDs/each optic** 1  
**Light colour** White  
**Required components:**

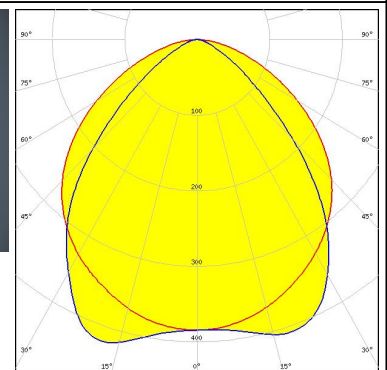
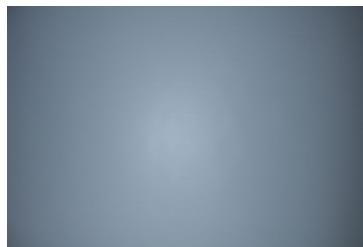

**LED** LM301A  
**FWHM / FWTM** 89.0 + 109.0° / 125.0 + 158.0°  
**Efficiency** 94 %  
**Peak intensity** 0.4 cd/lm  
**LEDs/each optic** 1  
**Light colour** White  
**Required components:**

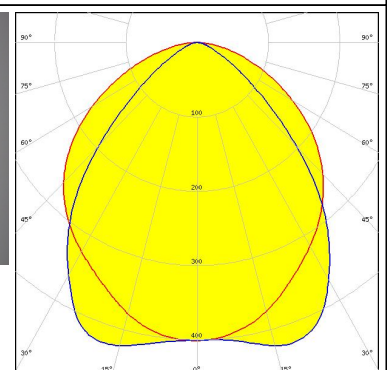
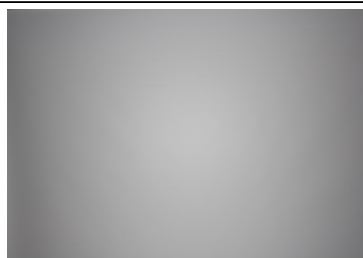

#### PHOTOMETRIC DATA (MEASURED):

### SAMSUNG

LED LM302A  
 FWHM / FWTM 90.0 + 108.0° / 128.0 + 159.0°  
 Efficiency 93 %  
 Peak intensity 0.4 cd/lm  
 LEDs/each optic 1  
 Light colour White  
 Required components:

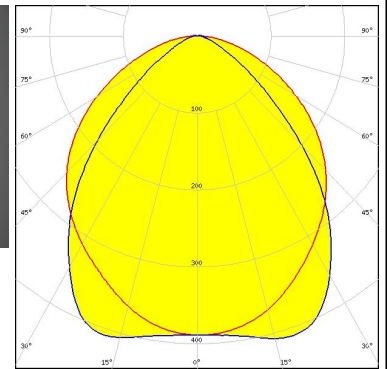
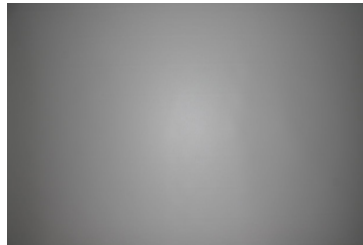

### SAMSUNG

LED LM561B  
 FWHM / FWTM 91.0 + 109.0° / 131.0 + 159.0°  
 Efficiency 93 %  
 Peak intensity 0.4 cd/lm  
 LEDs/each optic 1  
 Light colour White  
 Required components:

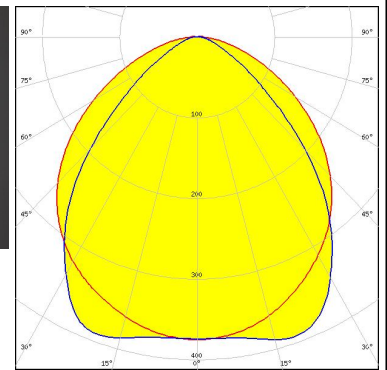
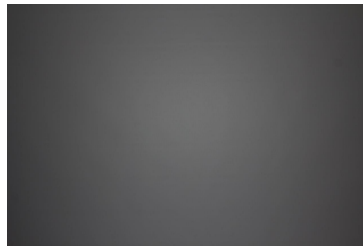

### SAMSUNG

LED LM561C  
 FWHM / FWTM 90.0 + 110.0° / 126.0 + 157.0°  
 Efficiency 94 %  
 Peak intensity 0.4 cd/lm  
 LEDs/each optic 1  
 Light colour White  
 Required components:

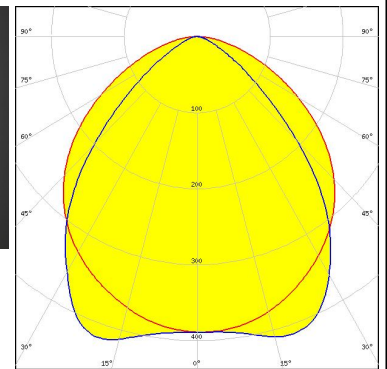
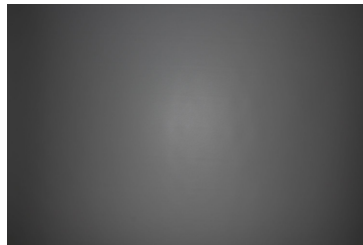



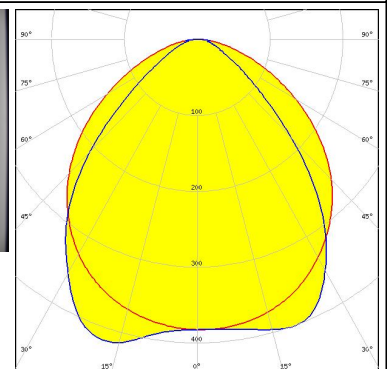
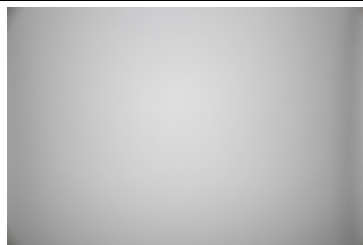

### SAMSUNG

LED LT-S282N  
 FWHM / FWTM 91.0 + 109.0° / 156.0 + 131.0°  
 Efficiency 94 %  
 Peak intensity 0.4 cd/lm  
 LEDs/each optic 1  
 Light colour White  
 Required components:

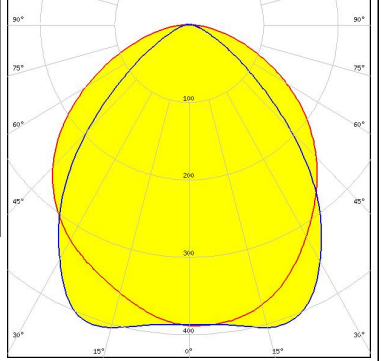

#### PHOTOMETRIC DATA (MEASURED):

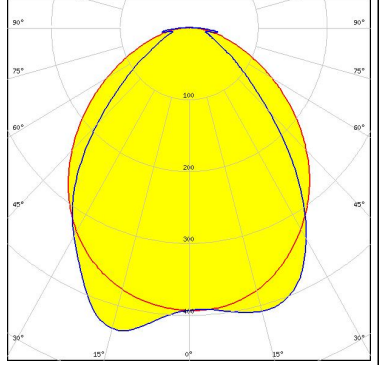
<p> SEOUL SEMICONDUCTOR</p> <p>LED: SEOUL 3030</p> <p>FWHM / FWTM: 90.0 + 109.0° / 127.0 + 158.0°</p> <p>Efficiency: 92 %</p> <p>Peak intensity: 0.4 cd/lm</p> <p>LEDs/each optic: 1</p> <p>Light colour: White</p> <p>Required components:</p>		
<p> SEOUL SEMICONDUCTOR</p> <p>LED: SEOUL DC 3030</p> <p>FWHM / FWTM: 103.0 + 86.0° / 156.0 + 151.0°</p> <p>Efficiency: 94 %</p> <p>Peak intensity: 0.4 cd/lm</p> <p>LEDs/each optic: 1</p> <p>Light colour: White</p> <p>Required components: C14353_FLORENCE-1R-CLIP-A</p>		



#### PHOTOMETRIC DATA (SIMULATED):

<p><b>LUMILEDS</b></p> <p>LED LUXEON 2835 Line</p> <p>FWHM / FWTM 90.0 + 111.0° / 114.0 + 152.0°</p> <p>Efficiency 93 %</p> <p>Peak intensity 0.4 cd/lm</p> <p>LEDs/each optic 1</p> <p>Light colour White</p> <p>Required components:</p>	
<p><b>LUMILEDS</b></p> <p>LED LUXEON 5050 Round LES</p> <p>FWHM / FWTM 91.0 + 111.0° / 120.0 + 153.0°</p> <p>Efficiency 94 %</p> <p>Peak intensity 0.4 cd/lm</p> <p>LEDs/each optic 1</p> <p>Light colour White</p> <p>Required components:</p>	
<p><b>OSRAM</b> Opto Semiconductors</p> <p>LED Duris E 2835</p> <p>FWHM / FWTM 94.0 + 106.0° / 120.0 + 150.0°</p> <p>Efficiency 93 %</p> <p>Peak intensity 0.4 cd/lm</p> <p>LEDs/each optic 1</p> <p>Light colour White</p> <p>Required components:</p>	
<p><b>OSRAM</b> Opto Semiconductors</p> <p>LED OSCONIQ C 2424</p> <p>FWHM / FWTM 117.0 + 96.0° / 152.0 + 106.0°</p> <p>Efficiency 94 %</p> <p>Peak intensity 0.4 cd/lm</p> <p>LEDs/each optic 1</p> <p>Light colour White</p> <p>Required components:</p>	

#### PHOTOMETRIC DATA (SIMULATED):

	
SEoul SEMICONDUCTOR	
LED	SEOUL DC 3030C
FWHM / FWTM	112.0 + 94.0° / 154.0 + 119.0°
Efficiency	93 %
Peak intensity	0.4 cd/lm
LEDs/each optic	1
Light colour	White
Required components:	



### GENERAL INFORMATION:

NOTE: The typical beam angle will be changed by different color, chip size and chip position tolerance. The typical total beam angle is the full angle measured where the luminous intensity is half of the peak value.

### MATERIALS:

As part of our continuous research and improvement processes, and to ensure the best possible quality and availability of our products, LEDiL reserves the right to change material grades without notice.

### PRODUCT DATA USER AGREEMENT AND DISCLAIMER:

The measured data in the provided downloadable LEDiL Product Datasheets and Mechanical 2D-Drawings is rounded and provided as reference for planning. LEDiL Oy's optical specifications have been verified by conducting performance testing of the products in accordance with the company's quality system. The reported data are averaged results of multiple measurements with typical variation. LEDiL Oy reserves the right to without prior notification make changes and improvements to its products.

LEDiL Oy assumes neither warranty, nor guarantee nor any other liability of any kind for the contents and correctness of the provided data. The provided data has been generated with highest diligence but the provided data may in reality not represent the complete possible variation range of all intrinsic parameters. Therefore, in certain cases a deviation from the provided data could occur.

LEDiL Oy reserves the right to undertake technical changes of its products without further notification which could lead to changes in the provided data. LEDiL Oy assumes no liability of any kind for the possible deviation from any provided data or any other damage resulting from the usage of the provided data.

The user agrees to this disclaimer and user agreement with the download or usage of the provided files.

#### LEDiL Oy

Joensuunkatu 13  
FI-24240 SALO  
Finland

#### LEDiL Inc.

228 West Page Street  
Suite D  
Sycamore IL 60178  
USA

#### Ledil Optics Technology (Shenzhen) Co., Ltd.

# 405 , Block B  
Casic Motor Building  
Shenzhen 518057  
P.R.CHINA

#### Local sales and technical support

[www.ledil.com/  
where\\_to\\_buy](http://www.ledil.com/where_to_buy)

#### Shipping locations

Salo, Finland  
Hong Kong, China

#### Distribution Partners

[www.ledil.com/  
where\\_to\\_buy](http://www.ledil.com/where_to_buy)

## X-ON Electronics

Largest Supplier of Electrical and Electronic Components

*Click to view similar products for [LED Lighting Lenses](#) category:*

*Click to view products by [Ledil](#) manufacturer:*

Other Similar products are found below :

[LL01ED-AK40L06](#) [LL01ZZ-EX25L06-M2](#) [180182-0000](#) [LL01ED-ALI55R49](#) [C14707\\_IDA16-O](#) [C12231\\_LENA-FRESNEL-LENS](#)  
[LL01ED-AKY24R49](#) [LL01CR-AYG15R49](#) [LL01CR-OT32L06-M2](#) [LL01ZZ-AAA24L49](#) [LL01CR-CEN38L02](#) [LL01ZZ-AAA55L49](#)  
[LL01CR-AYG24R49](#) [LL01A00CZMB2-M2](#) [LL01ED-AKY38R49](#) [LL01CR-CNE2545L06-M2](#) [LL01ZZ-AAA38L49](#) [LL01ED-AKV36R49](#)  
[LL01ED-ALI24R49](#) [LL01CR-AYG38R49](#) [C17171\\_DAISSY-8X1-SHD-MATT](#) [F16859\\_LINDA-ZT25](#) [C17295\\_ILONA-ZOOM](#)  
[F16636\\_LINDA-W60](#) [C17362\\_DAISSY-7X1-W-D](#) [C17361\\_DAISSY-7X1-WW-D](#) [10003](#) [10003/15](#) [10048](#) [10049](#) [10108](#) [10510](#)  
[F14487\\_FLORENCE-1R-MAXI-WG](#) [12667](#) [C14165\\_STRADA-2X2-ME-WIDE2](#) [C14605\\_HB-2X2-RW](#) [C14642\\_FLORENCE-1R-UP](#)  
[CAY033](#) [CAY046/55](#) [FCX11157\\_RES-O-90](#) [OS-LRI2015X45S](#) [OSOLRA2015M](#) [PG1C-NX36](#) [PG1C-SX17](#) [PM2A-SXV1](#) [PM2B-NX55-](#)  
[AW](#) [PM6A-FN25](#) [FC2231-0000-0050-L](#) [FC2231-0000-0100-L](#) [C14116\\_STRADA-2X2-PX](#)