

ANGELETTE-S-B-PLAIN

~10° spot beam. Clean appearance with no additional attachment interface and compatible with BJB connectors.

TECHNICAL SPECIFICATIONS:

Dimensions	Ø 110.0 mm
Height	57.3 mm
Fastening	socket
ROHS compliant	yes ⓘ

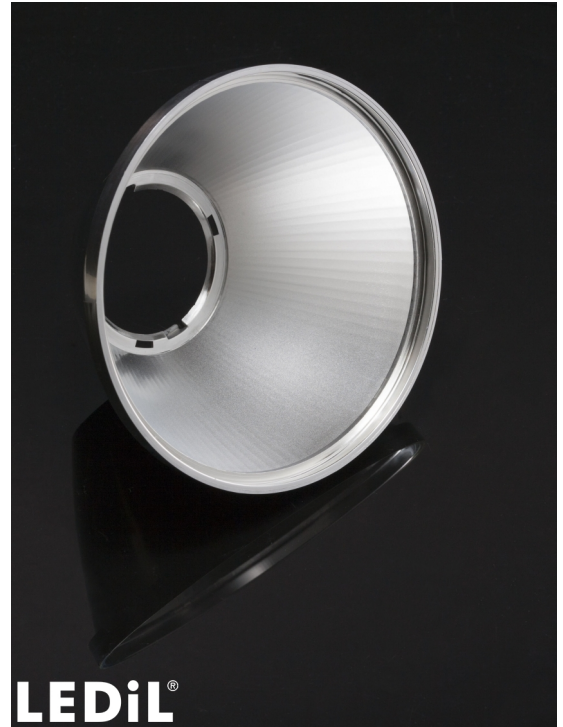

MATERIAL SPECIFICATIONS:

Component	Type	Material	Colour	Finish	Coating
ANGELETTE-S-B-PLAIN	Reflector	PC	metal		HMDS



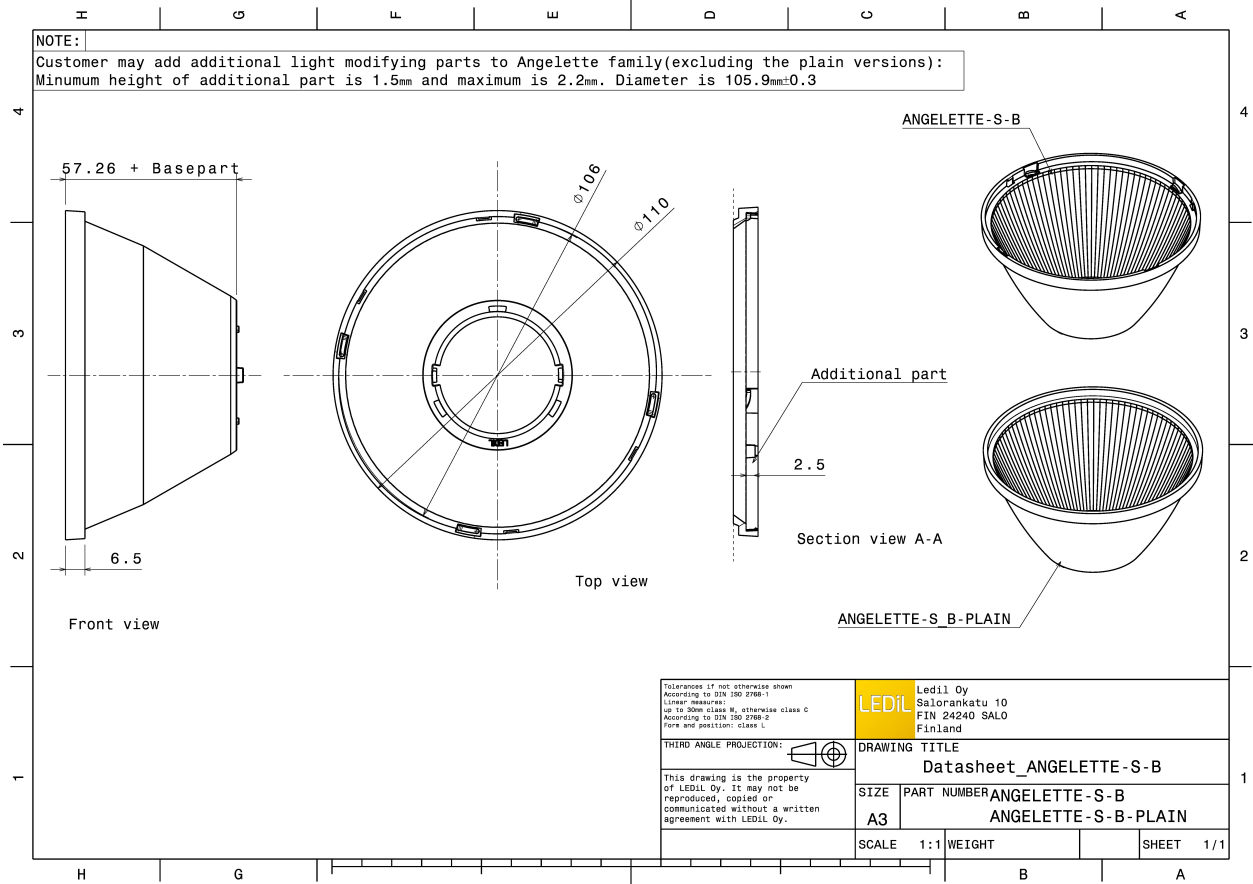

ORDERING INFORMATION:

Component	Qty in box	MOQ	MPQ	Box weight (kg)
F14624_ANGELETTE-S-B-PLAIN » Box size: 398 x 298 x 265 mm	180	90	45	7.6



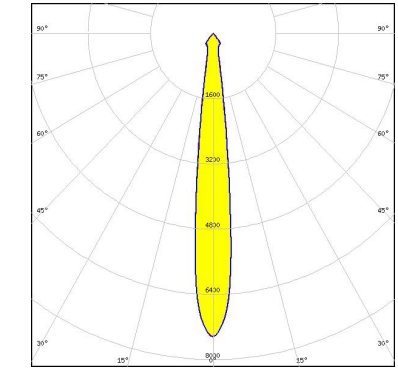

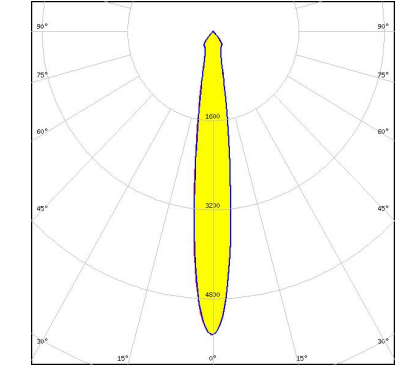
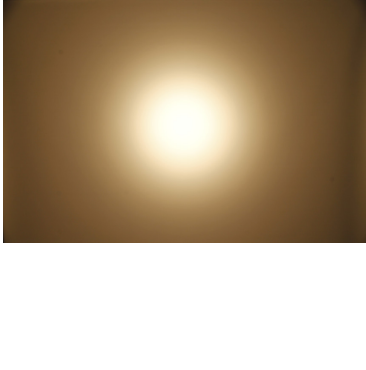
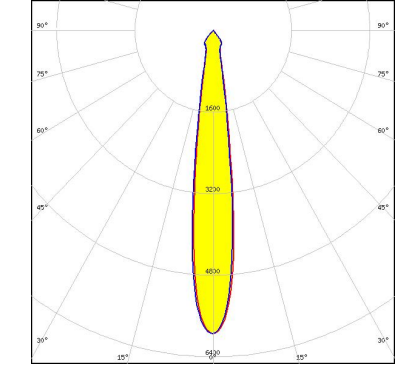

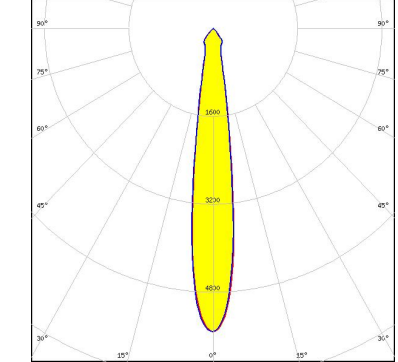
See also our general installation guide: www.ledil.com/installation_guide

PHOTOMETRIC DATA (MEASURED):

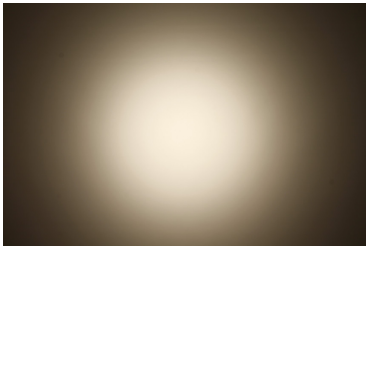
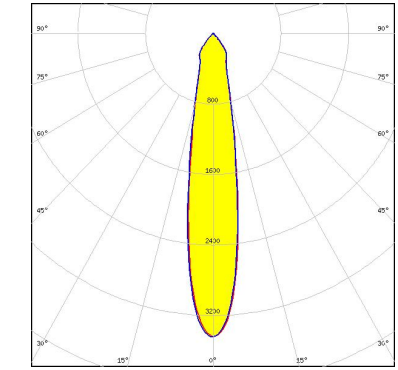
<p>bridgelux.</p> <p>LED V15 Gen6 FWHM 13.0° Efficiency 91 % Peak intensity 7.4 cd/lm LEDs/each optic 1 Light colour White Required components: BJB: 47.319.2224</p>		
<p>bridgelux.</p> <p>LED V15 Gen6 FWHM 14.0° Efficiency 87 % Peak intensity 5.4 cd/lm LEDs/each optic 1 Light colour White Required components: F13671_ANGE-RZ-LENS BJB: 47.319.2224</p>		
<p>bridgelux.</p> <p>LED V18 Gen6 FWHM 15.0° Efficiency 91 % Peak intensity 6 cd/lm LEDs/each optic 1 Light colour White Required components: BJB: 47.319.2274</p>		
<p>bridgelux.</p> <p>LED V18 Gen7 FWHM 15.0° Efficiency 91 % Peak intensity 5.5 cd/lm LEDs/each optic 1 Light colour White Required components: BJB: 47.319.2350</p>		

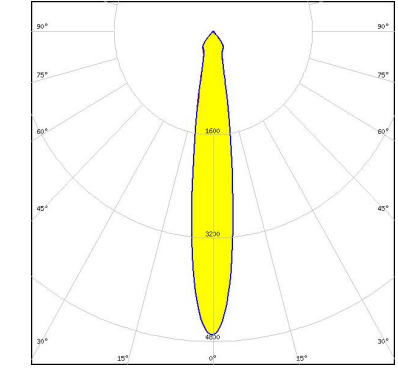
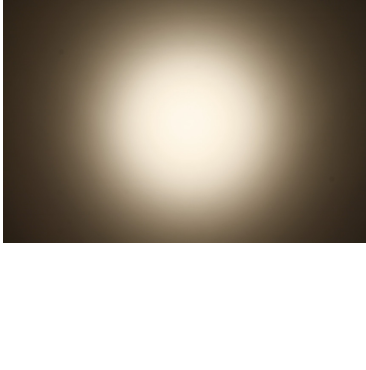
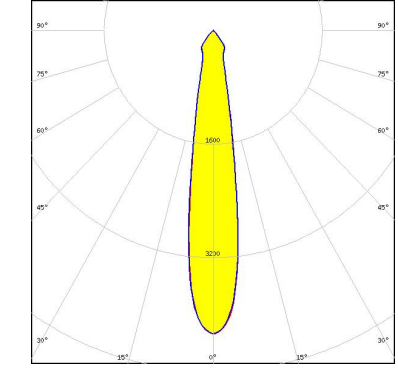
PHOTOMETRIC DATA (MEASURED):

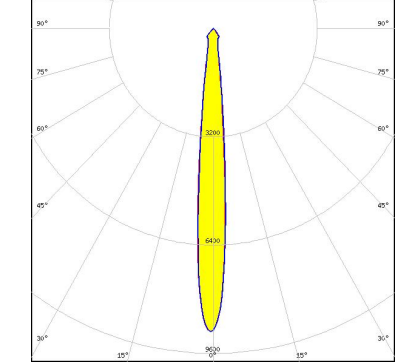
<p>bridgelux.</p> <p>LED V22 Gen6 FWHM 19.0° Efficiency 85 % Peak intensity 3.4 cd/lm LEDs/each optic 1 Light colour White Required components: F13671_ANGE-RZ-LENS A.A.G. STUCCHI: 8102/G2</p>		
<p>bridgelux.</p> <p>LED V22 Gen6 FWHM 16.0° Efficiency 88 % Peak intensity 4.7 cd/lm LEDs/each optic 1 Light colour White Required components: F13671_ANGE-RZ-LENS BJB: 47.319.2274</p>		
<p>bridgelux.</p> <p>LED V22 Gen6 FWHM 18.0° Efficiency 89 % Peak intensity 4.3 cd/lm LEDs/each optic 1 Light colour White Required components: A.A.G. STUCCHI: 8102/G2</p>		
<p>CREE ⇄</p> <p>LED CXA/B 1816 & CXA/B 1820 & CXA 1850 FWHM 10.0° Efficiency 90 % Peak intensity 9 cd/lm LEDs/each optic 1 Light colour White Required components:</p>		

PHOTOMETRIC DATA (MEASURED):

LUMILEDS

LED LUXEON CoB 1208
 FWHM 14.0°
 Efficiency 87 %
 Peak intensity 5.6 cd/lm
 LEDs/each optic 1
 Light colour White
 Required components:
 F13671_ANGE-RZ-LENS
 A.A.G. STUCCHI: 8301/G2

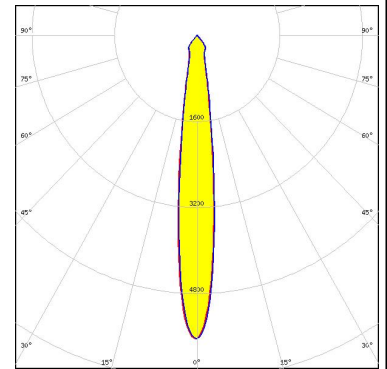

LUMILEDS

LED LUXEON CoB 1208
 FWHM 12.0°
 Efficiency 91 %
 Peak intensity 7.8 cd/lm
 LEDs/each optic 1
 Light colour White
 Required components:
 A.A.G. STUCCHI: 8301/G2

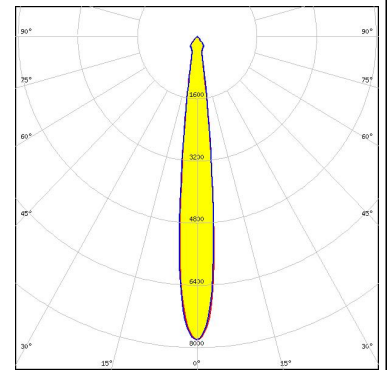

SAMSUNG

LED LC016D / LC019D / LC026D / LC033D
 FWHM 14.0°
 Efficiency 88 %
 Peak intensity 5.7 cd/lm
 LEDs/each optic 1
 Light colour White
 Required components:
 F13671_ANGE-RZ-LENS
 BJB: 47.319.2021

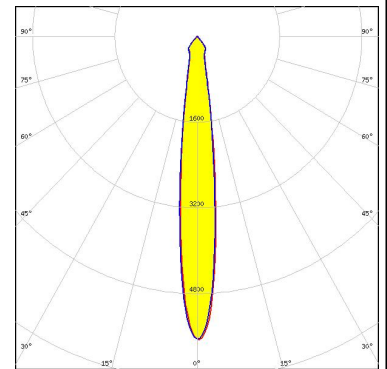

SAMSUNG

LED LC016D / LC019D / LC026D / LC033D
 FWHM 14.0°
 Efficiency 88 %
 Peak intensity 5.7 cd/lm
 LEDs/each optic 1
 Light colour White
 Required components:
 F13671_ANGE-RZ-LENS
 A.A.G. STUCCHI: 8101/G2

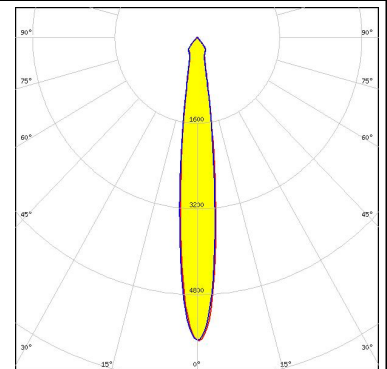
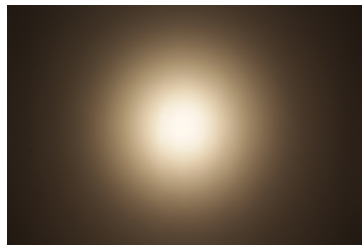

PHOTOMETRIC DATA (MEASURED):

SAMSUNG

LED LC016D / LC019D / LC026D / LC033D
 FWHM 12.0°
 Efficiency 91 %
 Peak intensity 7.7 cd/lm
 LEDs/each optic 1
 Light colour White
 Required components:
 BJB: 47.319.2021

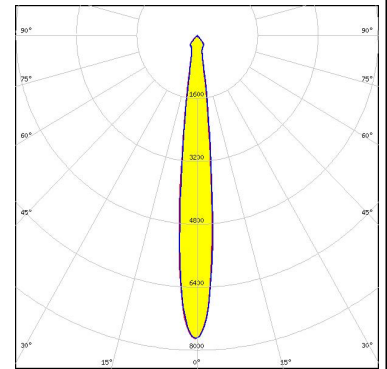

SAMSUNG

LED LC016D / LC019D / LC026D / LC033D
 FWHM 12.0°
 Efficiency 91 %
 Peak intensity 7.7 cd/lm
 LEDs/each optic 1
 Light colour White
 Required components:
 A.A.G. STUCCHI: 8101/G2

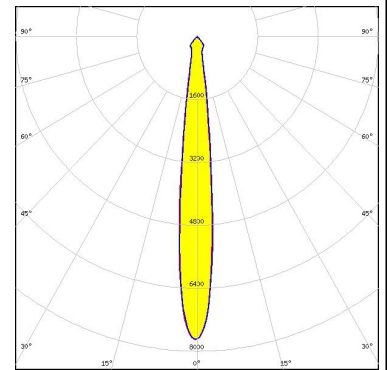

LED AC Zhaga COB
 FWHM 12.0°
 Efficiency 90 %
 Peak intensity 7.7 cd/lm
 LEDs/each optic 1
 Light colour White
 Required components:

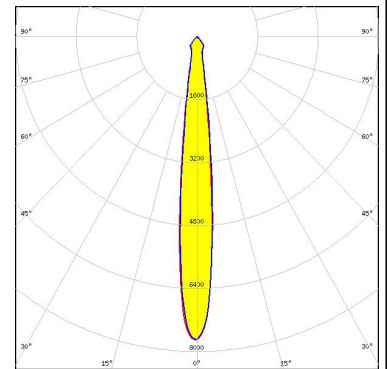

XICATO

LED XTM - 19mm LES
 FWHM 14.0°
 Efficiency 92 %
 Peak intensity 6.6 cd/lm
 LEDs/each optic 1
 Light colour White
 Required components:
 C15743_XTM-ADAPTER-50-B

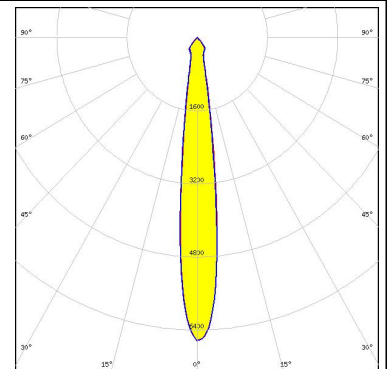

PHOTOMETRIC DATA (SIMULATED):

CITIZEN

LED CLL03x/CLU03x
FWHM 12.0°
Efficiency 94 %
Peak intensity 11.2 cd/lm
LEDs/each optic 1
Light colour White
Required components:
BJB: 47.319.2021

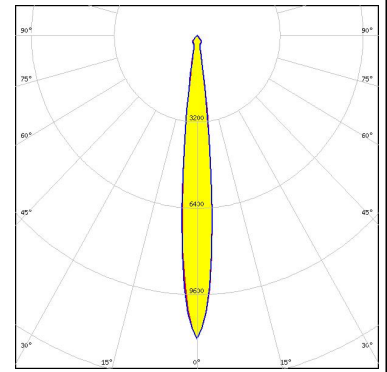

SAMSUNG

LED LC040D / LC060D / LC080D
FWHM 18.0°
Efficiency 88 %
Peak intensity 4.5 cd/lm
LEDs/each optic 1
Light colour White
Required components:
BJB: 47.319.2030

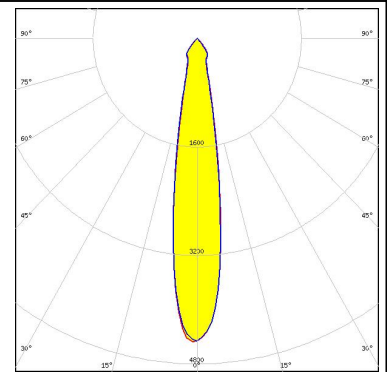

GENERAL INFORMATION:

NOTE: The typical beam angle will be changed by different color, chip size and chip position tolerance. The typical total beam angle is the full angle measured where the luminous intensity is half of the peak value.

Due to use of high power COB's with this product, special attention to proper thermal design is highly recommended. LEDiL has no liability for direct, indirect or consecutive damages arising from the LEDiL products being used outside of the recommended temperature range.

MATERIALS:

As part of our continuous research and improvement processes, and to ensure the best possible quality and availability of our products, LEDiL reserves the right to change material grades without notice.

PRODUCT DATA USER AGREEMENT AND DISCLAIMER:

The measured data in the provided downloadable LEDiL Product Datasheets and Mechanical 2D-Drawings is rounded and provided as reference for planning. LEDiL Oy's optical specifications have been verified by conducting performance testing of the products in accordance with the company's quality system. The reported data are averaged results of multiple measurements with typical variation. LEDiL Oy reserves the right to without prior notification make changes and improvements to its products.

LEDiL Oy assumes neither warranty, nor guarantee nor any other liability of any kind for the contents and correctness of the provided data. The provided data has been generated with highest diligence but the provided data may in reality not represent the complete possible variation range of all intrinsic parameters. Therefore, in certain cases a deviation from the provided data could occur.

LEDiL Oy reserves the right to undertake technical changes of its products without further notification which could lead to changes in the provided data. LEDiL Oy assumes no liability of any kind for the possible deviation from any provided data or any other damage resulting from the usage of the provided data.

The user agrees to this disclaimer and user agreement with the download or usage of the provided files.

LEDiL Oy

Joensuunkatu 13
FI-24240 SALO
Finland

LEDiL Inc.

228 West Page Street
Suite D
Sycamore IL 60178
USA

Ledil Optics Technology (Shenzhen) Co., Ltd.

405 , Block B
Casic Motor Building
Shenzhen 518057
P.R.CHINA

Local sales and technical support

[www.ledil.com/
where_to_buy](http://www.ledil.com/where_to_buy)

Shipping locations

Salo, Finland
Hong Kong, China

Distribution Partners

[www.ledil.com/
where_to_buy](http://www.ledil.com/where_to_buy)

X-ON Electronics

Largest Supplier of Electrical and Electronic Components

Click to view similar products for [LED Lighting Reflectors](#) category:

Click to view products by [Ledil](#) manufacturer:

Other Similar products are found below :

[LL04CR-CFN35155L02](#) [LL04CR-CFN60155L02](#) [LL04CR-CGM85135L02](#) [F13185_GERI-RZ](#) [10604](#) [LL01SP-ATH15R49](#) [10170](#) [12527](#)
[12531](#) [12568](#) [C13253_TINA2-R-CLIP16](#) [CA14591_BROOKE-XW](#) [F15560_MIRELLA-G2-W](#) [CA11525_LAURA-R-W](#) [12796](#) [LMH020-](#)
[REFL-0000-0000062](#) [LMH020-REFL-0000-0000082](#) [C12606_LENINA-DL](#) [CN12711_LENINA-W-DL](#) [C11394_TYRA-S](#) [C11396_TYRA-](#)
[W](#) [C11508_BROOKE-W](#) [C11552_BARBARA-S](#) [C11553_BARBARA-W](#) [C11862_MINNIE-W](#) [C11979_LENA-S](#) [C11980_LENA-W](#)
[C11996_LENA-LENS](#) [C12083_BROOKE-SCR-M](#) [C12095_MINNIE-M](#) [C12097_MINNIE-WWW](#) [C12154_LENA-M](#) [C12469_LISA2-R-](#)
[PIN](#) [C12476_MIRELLA-50-S](#) [C12477_MIRELLA-50-M](#) [C12480_MIRELLA-50-S-PIN](#) [C12516_RITA-WAS](#) [C12597_LENINA-S](#)
[C12599_LENINA-W](#) [C12948_LENA-WAS](#) [C12958_LENINA-XW](#) [C13085_MIRELLA-50-S-PF](#) [C13087_MIRELLA-50-W-PF](#)
[C13101_LENA-X-WAS](#) [C13555_BRIDGET-W-UNI](#) [C13556_BRIDGET-M-UNI](#) [C13557_BRIDGET-S-UNI](#) [C14346_ANGELETTE-WAS](#)
[C17099_ALISE-50-DL](#) [C17095_ALISE-70-CL](#)