

CARMEN-90-RS

~10° beam

TECHNICAL SPECIFICATIONS:

Dimensions	Ø 89.8 mm
Height	39.3 mm
Fastening	socket
Colour	clear
Box size	480 x 280 x 300 mm
Box weight	7 kg
Quantity in Box	70 pcs
ROHS compliant	yes ⓘ







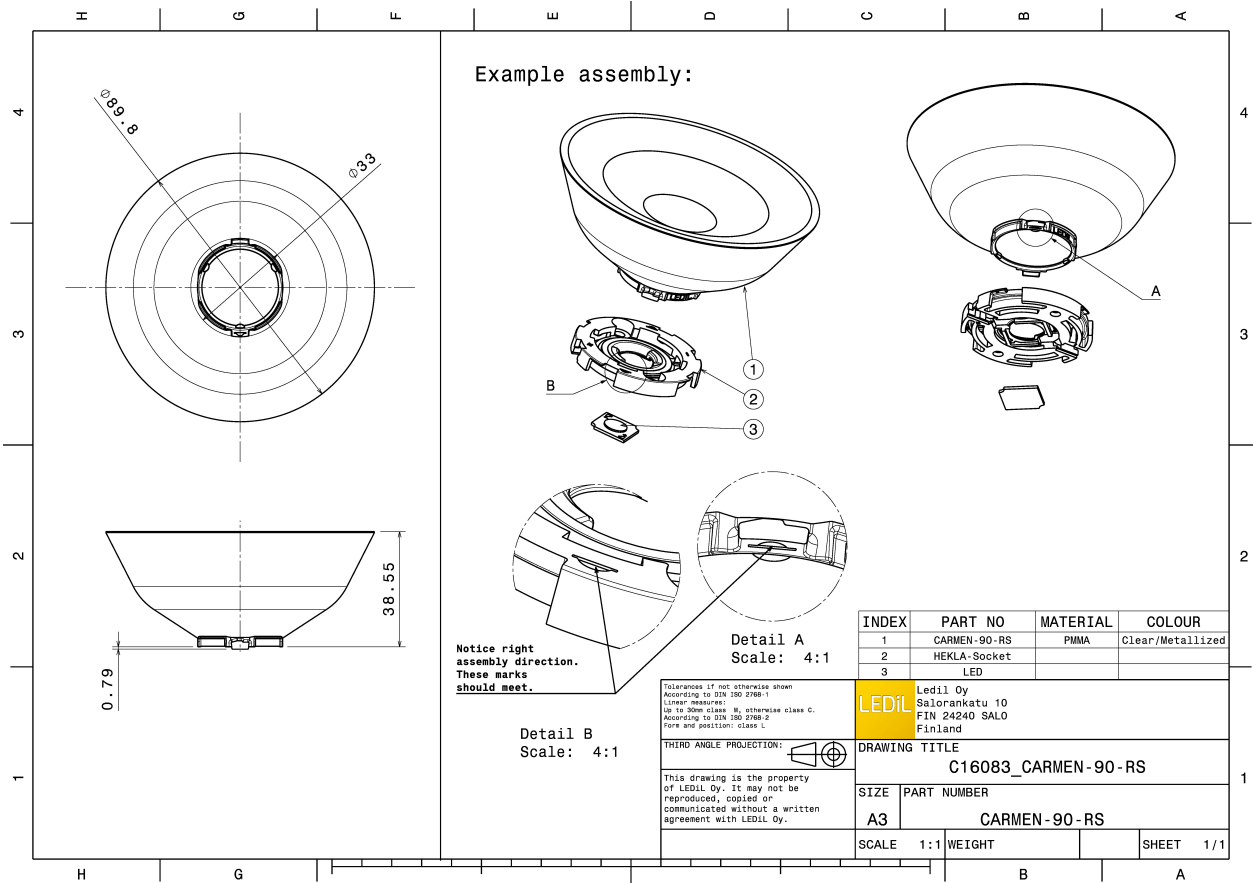

MATERIAL SPECIFICATIONS:

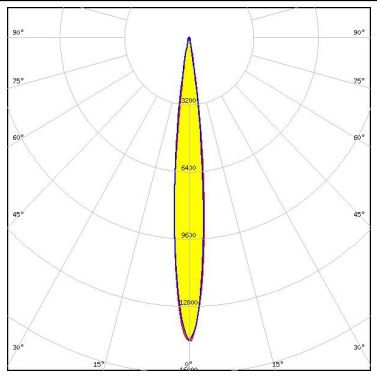
Component	Type	Material	Colour
CARMEN-90-RS	Single lens	PMMA	clear

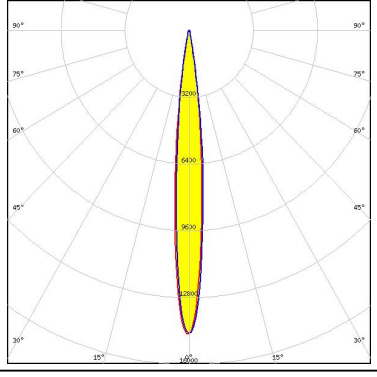

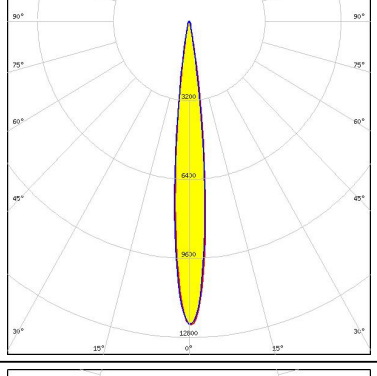
PHOTOMETRIC DATA (MEASURED):

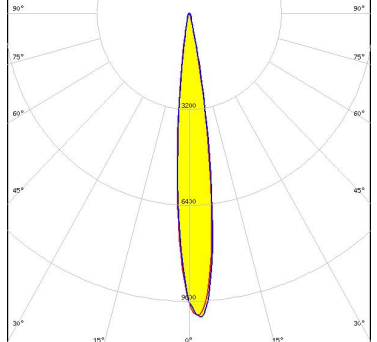
<p>bridgelux.</p> <p>LED V6 HD FWHM 11.0° Efficiency 83 % Peak intensity 14.500 cd/lm LEDs/each optic 1 Light colour White Required components: F15255_HEKLA-SOCKET-C</p>		
<p>bridgelux.</p> <p>LED V9 HD FWHM 11.0° Efficiency 83 % Peak intensity 14.600 cd/lm LEDs/each optic 1 Light colour White Required components: F15859_HEKLA-SOCKET-I</p>		
<p>bridgelux.</p> <p>LED V9 HD FWHM 12.0° Efficiency 81 % Peak intensity 12.300 cd/lm LEDs/each optic 1 Light colour White Required components: F15859_HEKLA-SOCKET-I</p>		
<p>CITIZEN</p> <p>LED CLL02x/CLU02x (LES10) FWHM 13.0° Efficiency 82 % Peak intensity 10.700 cd/lm LEDs/each optic 1 Light colour White Required components: F15255_HEKLA-SOCKET-C</p>		

PHOTOMETRIC DATA (MEASURED):

CITIZEN

LED CLL03x/CLU03x
FWHM 15.0°
Efficiency 82 %
Peak intensity 7.600 cd/lm
LEDs/each optic 1
Light colour White
Required components:
F15859_HEKLA-SOCKET-I

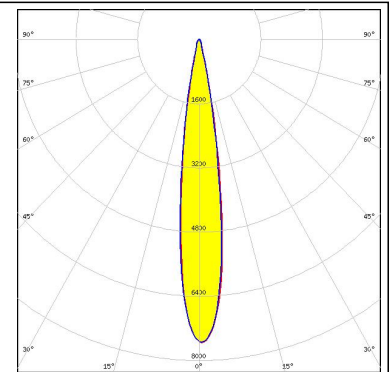
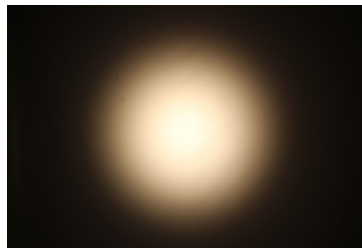

CITIZEN

LED CLU700/701
FWHM 10.0°
Efficiency 81 %
Peak intensity 15.600 cd/lm
LEDs/each optic 1
Light colour White
Required components:
F15255_HEKLA-SOCKET-C

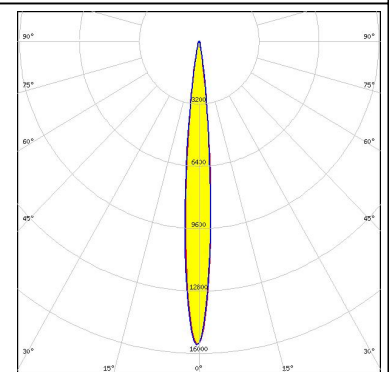
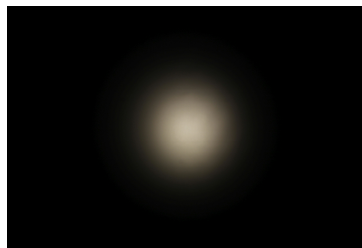

CITIZEN

LED CLU710/711
FWHM 11.0°
Efficiency 82 %
Peak intensity 14.600 cd/lm
LEDs/each optic 1
Light colour White
Required components:
F15859_HEKLA-SOCKET-I

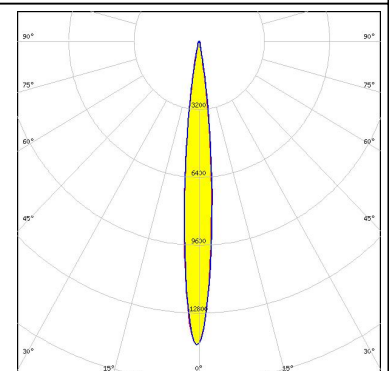

CITIZEN

LED CLU7A2 (LES 4.2mm)
FWHM 9.0°
Efficiency 82 %
Peak intensity 20.300 cd/lm
LEDs/each optic 1
Light colour White
Required components:
F15255_HEKLA-SOCKET-C

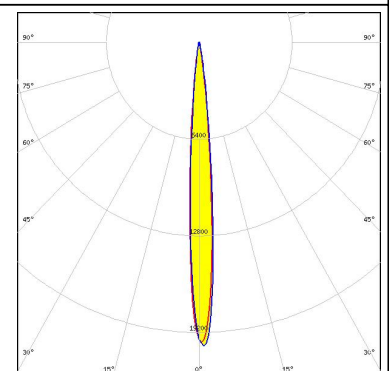
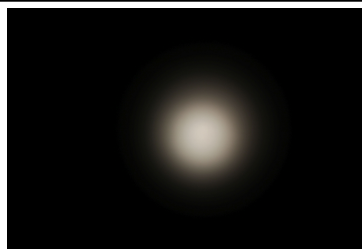

PHOTOMETRIC DATA (MEASURED):

CREE 

LED CMT14xx
 FWHM 12.0°
 Efficiency 83 %
 Peak intensity 12.600 cd/lm
 LEDs/each optic 1
 Light colour White
 Required components:
 F15255_HEKLA-SOCKET-C

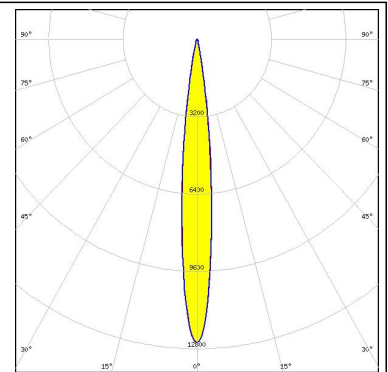

CREE 

LED CMT19xx
 FWHM 16.0°
 Efficiency 83 %
 Peak intensity 7.560 cd/lm
 LEDs/each optic 1
 Light colour White
 Required components:
 F15859_HEKLA-SOCKET-I

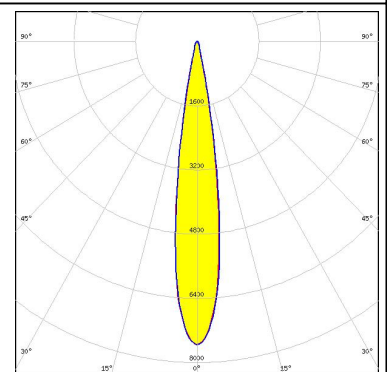

CREE 

LED CXA/B 15xx
 FWHM 12.0°
 Efficiency 83 %
 Peak intensity 12.500 cd/lm
 LEDs/each optic 1
 Light colour White
 Required components:
 F15256_HEKLA-SOCKET-D

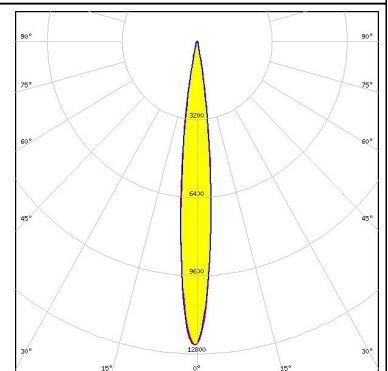
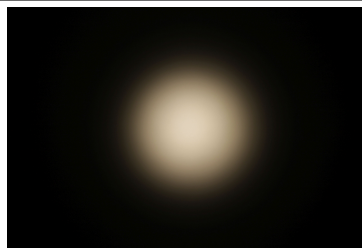

CREE 

LED CXA/B 1816 & CXA/B 1820 & CXA 1850
 FWHM 16.0°
 Efficiency 82 %
 Peak intensity 7.600 cd/lm
 LEDs/each optic 1
 Light colour White
 Required components:
 F15254_HEKLA-SOCKET-B

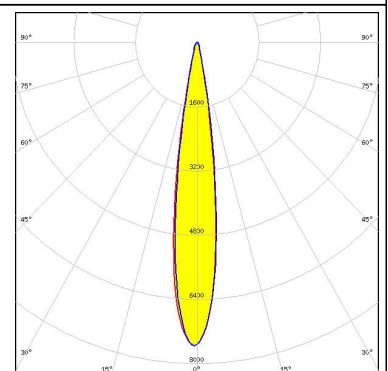
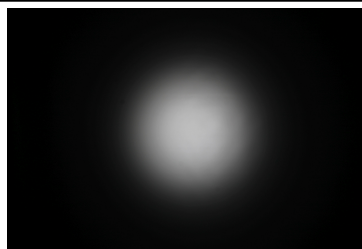

PHOTOMETRIC DATA (MEASURED):

LUMILEDS

LED LUXEON CoB 1202HD
 FWHM 11.0°
 Efficiency 84 %
 Peak intensity 14.800 cd/lm
 LEDs/each optic 1
 Light colour White
 Required components:
 F15848_HEKLA-SOCKET-G

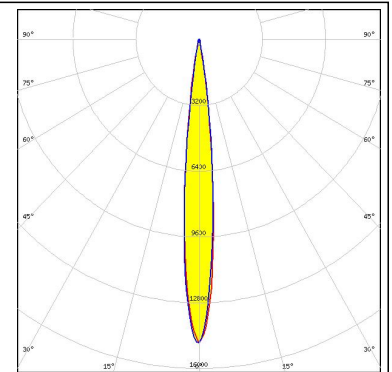
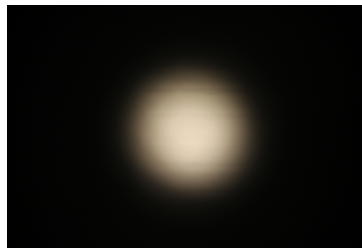

LUMILEDS

LED LUXEON CoB 1204HD
 FWHM 11.0°
 Efficiency 84 %
 Peak intensity 14.000 cd/lm
 LEDs/each optic 1
 Light colour White
 Required components:
 F15858_HEKLA-SOCKET-H

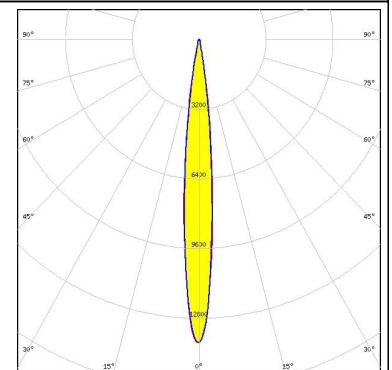
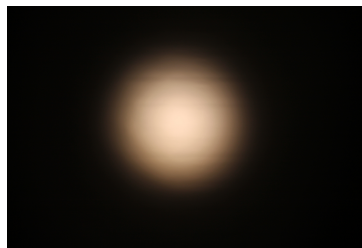

LUMILEDS

LED LUXEON CoB 1205HD
 FWHM 13.0°
 Efficiency 83 %
 Peak intensity 11.150 cd/lm
 LEDs/each optic 1
 Light colour White
 Required components:
 F15858_HEKLA-SOCKET-H

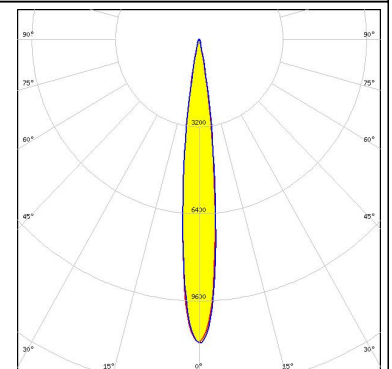
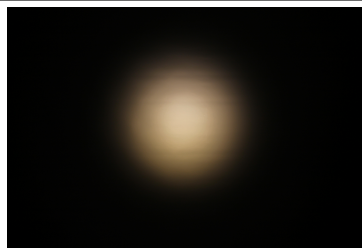

SAMSUNG

LED COB D Series LES 9.8 mm
 FWHM 13.0°
 Efficiency 83 %
 Peak intensity 10.200 cd/lm
 LEDs/each optic 1
 Light colour White
 Required components:
 F15255_HEKLA-SOCKET-C

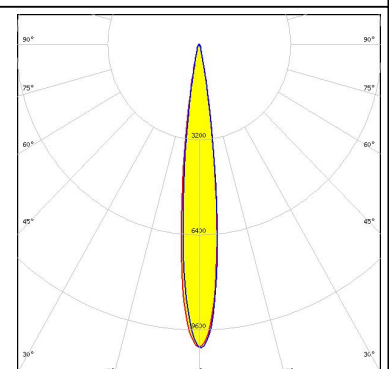
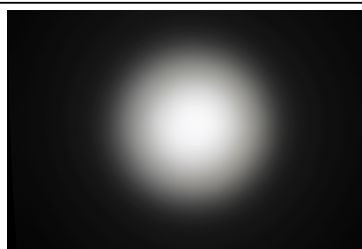

PHOTOMETRIC DATA (MEASURED):

SAMSUNG

LED LC010C G2
 FWHM 10.0°
 Efficiency 81 %
 Peak intensity 16.000 cd/lm
 LEDs/each optic 1
 Light colour White
 Required components:
 F15255_HEKLA-SOCKET-C

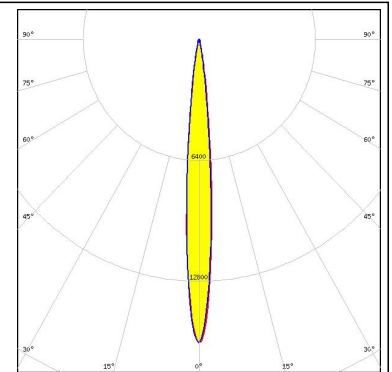
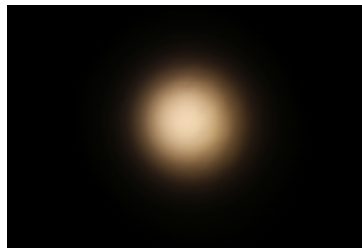

SAMSUNG

LED LC020C G2
 FWHM 13.0°
 Efficiency 80 %
 Peak intensity 10.300 cd/lm
 LEDs/each optic 1
 Light colour White
 Required components:
 F15859_HEKLA-SOCKET-I

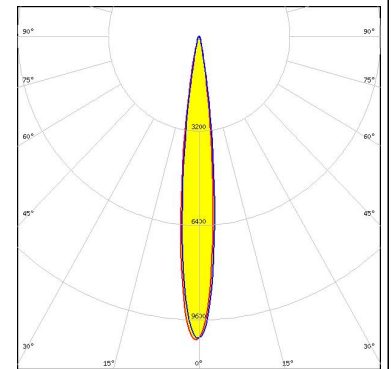

TRIDONIC

LED SLE G7 LES09
 FWHM 13.0°
 Efficiency 81 %
 Peak intensity 11.000 cd/lm
 LEDs/each optic 1
 Light colour White
 Required components:
 F15255_HEKLA-SOCKET-C

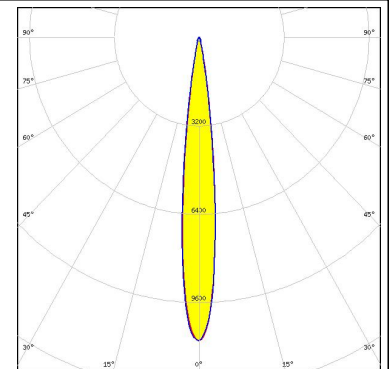

TRIDONIC

LED SLE G7 LES13
 FWHM 16.0°
 Efficiency 81 %
 Peak intensity 7.200 cd/lm
 LEDs/each optic 1
 Light colour White
 Required components:
 F15859_HEKLA-SOCKET-I

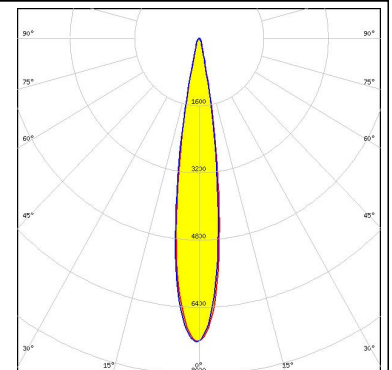
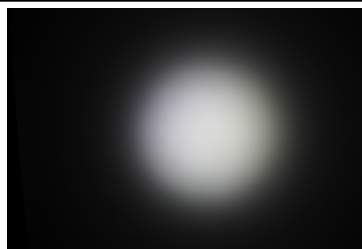

PHOTOMETRIC DATA (MEASURED):

TRIDONIC

LED SLE G7 LES15
FWHM 18.0°
Efficiency 82 %
Peak intensity 6.200 cd/lm
LEDs/each optic 1
Light colour White
Required components:
F15859_HEKLA-SOCKET-I

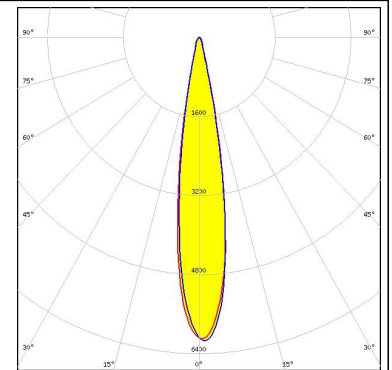

XICATO

LED XOB 6 mm
FWHM 10.0°
Efficiency 80 %
Peak intensity 16.042 cd/lm
LEDs/each optic 1
Light colour White
Required components:
F15255_HEKLA-SOCKET-C

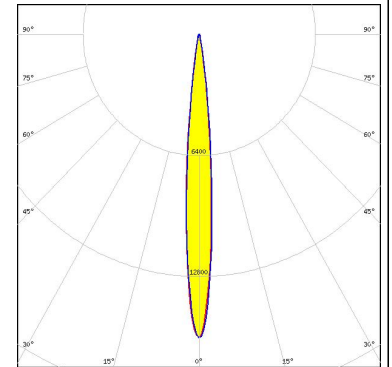
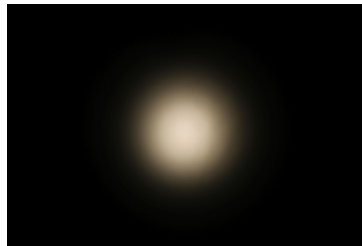

XICATO

LED XOB 9.8 mm
FWHM 13.0°
Efficiency 81 %
Peak intensity 11.137 cd/lm
LEDs/each optic 1
Light colour White
Required components:
F15255_HEKLA-SOCKET-C

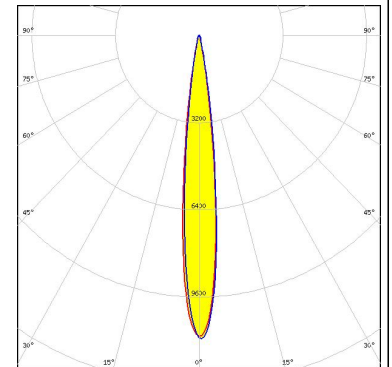

PHOTOMETRIC DATA (SIMULATED):

CITIZEN

LED CLL03x/CLU03x
FWHM 17.0°
Efficiency 83 %
Peak intensity 7.600 cd/lm
LEDs/each optic 1
Light colour White
Required components:
F15859_HEKLA-SOCKET-I

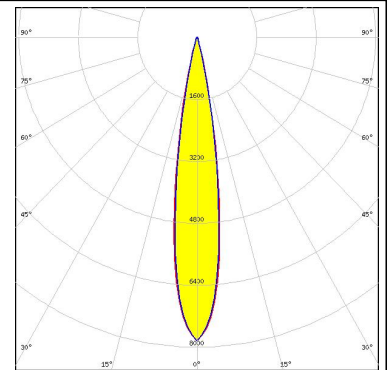

CREE

LED CXA/B 13xx
FWHM 9.0°
Efficiency 86 %
Peak intensity 27.300 cd/lm
LEDs/each optic 1
Light colour White
Required components:
F15956_HEKLA-SOCKET-J

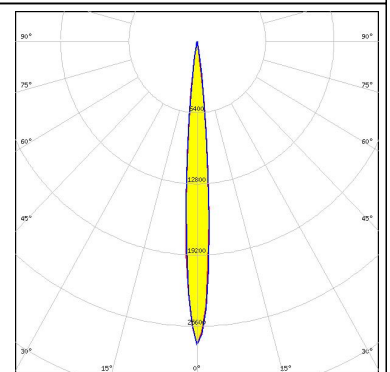

LUMILEDS

LED LUXEON CoB 1208
FWHM 17.0°
Efficiency 85 %
Peak intensity 7.590 cd/lm
LEDs/each optic 1
Light colour White
Required components:
C16142_HEKLA-SOCKET-K

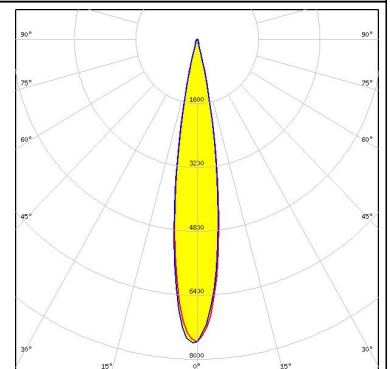

GENERAL INFORMATION:

NOTE: The typical beam angle will be changed by different color, chip size and chip position tolerance. The typical total beam angle is the full angle measured where the luminous intensity is half of the peak value.

Due to use of high power COB's with this product, special attention to proper thermal design is highly recommended. LEDiL has no liability for direct, indirect or consecutive damages arising from the LEDiL products being used outside of the recommended temperature range.

MATERIALS:

As part of our continuous research and improvement processes, and to ensure the best possible quality and availability of our products, LEDiL reserves the right to change material grades without notice.

PRODUCT DATA USER AGREEMENT AND DISCLAIMER:

The measured data in the provided downloadable LEDiL Product Datasheets and Mechanical 2D-Drawings is rounded and provided as reference for planning. LEDiL Oy's optical specifications have been verified by conducting performance testing of the products in accordance with the company's quality system. The reported data are averaged results of multiple measurements with typical variation. LEDiL Oy reserves the right to without prior notification make changes and improvements to its products.

LEDiL Oy assumes neither warranty, nor guarantee nor any other liability of any kind for the contents and correctness of the provided data. The provided data has been generated with highest diligence but the provided data may in reality not represent the complete possible variation range of all intrinsic parameters. Therefore, in certain cases a deviation from the provided data could occur.

LEDiL Oy reserves the right to undertake technical changes of its products without further notification which could lead to changes in the provided data. LEDiL Oy assumes no liability of any kind for the possible deviation from any provided data or any other damage resulting from the usage of the provided data.

The user agrees to this disclaimer and user agreement with the download or usage of the provided files.

LEDiL Oy

Joensuunkatu 13
FI-24240 SALO
Finland

LEDiL Inc.

228 West Page Street
Suite D
Sycamore IL 60178
USA

Local sales and technical support

[www.ledil.com/
where_to_buy](http://www.ledil.com/where_to_buy)

Shipping locations

Salo, Finland
Hong Kong, China

Distribution Partners

[www.ledil.com/
where_to_buy](http://www.ledil.com/where_to_buy)

X-ON Electronics

Largest Supplier of Electrical and Electronic Components

Click to view similar products for [LED Lighting Lenses](#) category:

Click to view products by [Ledil](#) manufacturer:

Other Similar products are found below :

[LL01ED-AK40L06](#) [LL01ZZ-EX25L06-M2](#) [180182-0000](#) [LL01ED-ALI55R49](#) [C14707_IDA16-O](#) [C12231_LENA-FRESNEL-LENS](#)
[LL01ED-AKY24R49](#) [LL01CR-AYG15R49](#) [LL01CR-OT32L06-M2](#) [LL01ZZ-AAA24L49](#) [LL01CR-CEN38L02](#) [LL01ZZ-AAA55L49](#)
[LL01CR-AYG24R49](#) [LL01A00CZMB2-M2](#) [LL01ED-AKY38R49](#) [LL01CR-CNE2545L06-M2](#) [LL01ZZ-AAA38L49](#) [LL01ED-AKV36R49](#)
[LL01ED-ALI24R49](#) [LL01CR-AYG38R49](#) [C17171_DAISSY-8X1-SHD-MATT](#) [F16859_LINDA-ZT25](#) [C17295_ILONA-ZOOM](#)
[F16636_LINDA-W60](#) [C17362_DAISSY-7X1-W-D](#) [C17361_DAISSY-7X1-WW-D](#) [10003](#) [10003/15](#) [10048](#) [10049](#) [10108](#) [10510](#)
[F14487_FLORENCE-1R-MAXI-WG](#) [12667](#) [C14165_STRADA-2X2-ME-WIDE2](#) [C14605_HB-2X2-RW](#) [C14642_FLORENCE-1R-UP](#)
[CAY033](#) [CAY046/55](#) [FCX11157_RES-O-90](#) [OS-LRI2015X45S](#) [OSOLRA2015M](#) [PG1C-NX36](#) [PG1C-SX17](#) [PM2A-SXV1](#) [PM2B-NX55-](#)
[AW](#) [PM6A-FN25](#) [FC2231-0000-0050-L](#) [FC2231-0000-0100-L](#) [C14116_STRADA-2X2-PX](#)