

VIOLETTA-W

~60° wide beam

TECHNICAL SPECIFICATIONS:

Dimensions	21.7 x 21.7 mm
Height	6.5 mm
Fastening	pin
ROHS compliant	yes ⓘ

MATERIAL SPECIFICATIONS:

Component	Type	Material	Colour	Finish
VIOLETTA-W	Single lens	Silicone	clear	gloss

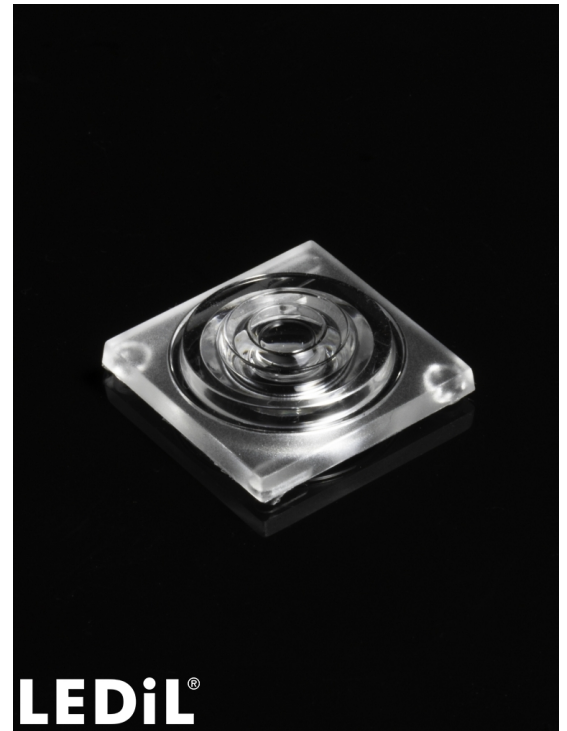

ORDERING INFORMATION:

Component	Qty in box	MOQ	MPQ	Box weight (kg)
F17826_VIOLETTA-W » Box size: 485 x 280 x 100 mm	2025	270	135	4.3

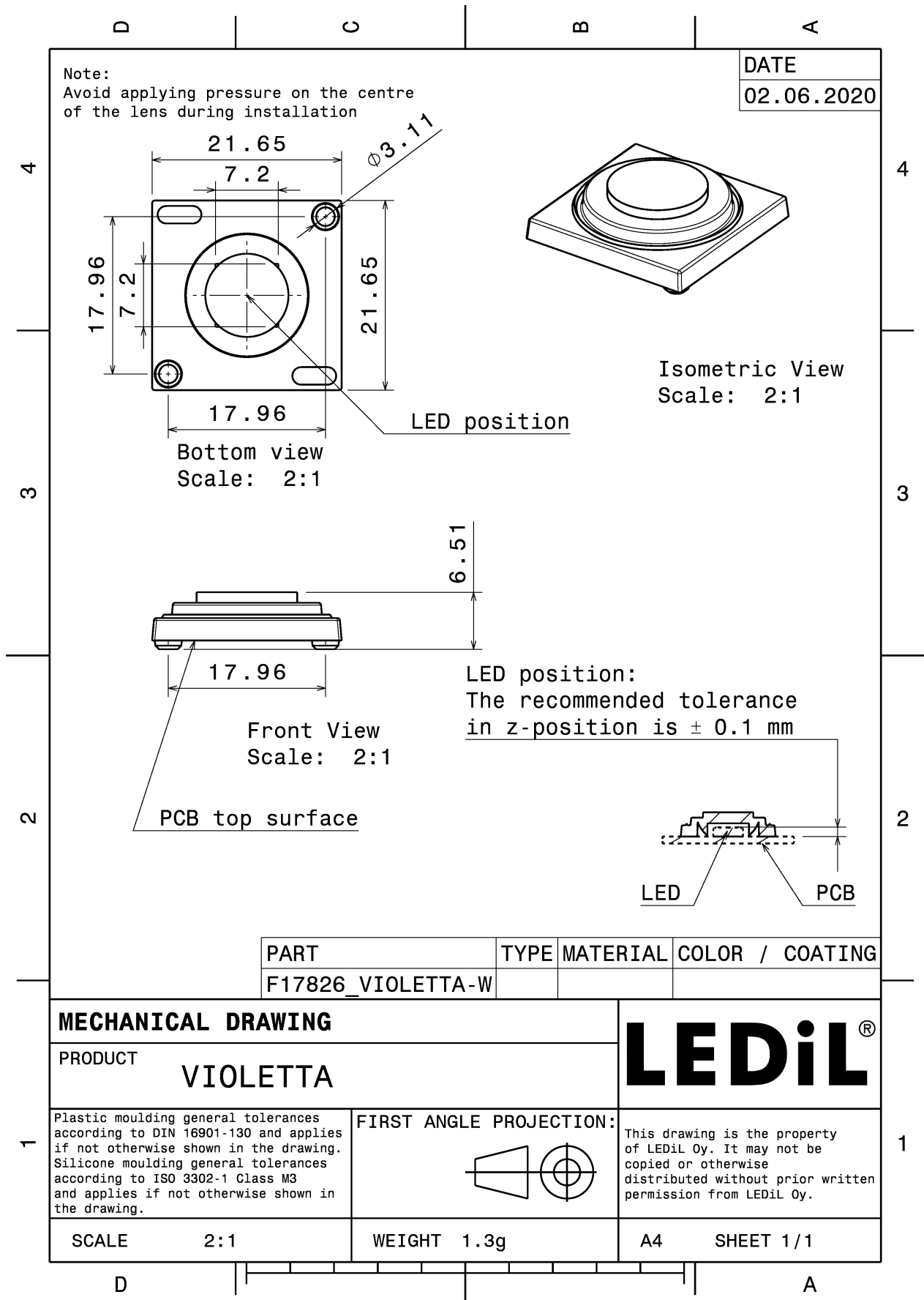

See also our general installation guide: www.ledil.com/installation_guide

PHOTOMETRIC DATA (MEASURED):

Crystal[✦]IS

LED KL265-50V-SM-WD
FWHM / FWTM 48.0° / 68.0°
Efficiency 62 %
LEDs/each optic 1
Light colour UV-C
Required components:

The UVC LED result tolerance is ± 10 %



LED S3535-DR100-W272-P40
FWHM / FWTM 52.0° / 72.0°
Efficiency 81 %
LEDs/each optic 1
Light colour UV-C
Required components:

The UVC LED result tolerance is ± 10 %



LED XFM-5050 2 Die
FWHM / FWTM 56.0° / 74.0°
Efficiency 65 %
LEDs/each optic 1
Light colour UV-C
Required components:

The UVC LED result tolerance is ± 10 %



LED XFM-5050 3 Die
FWHM / FWTM 55.0° / 73.0°
Efficiency 78 %
LEDs/each optic 1
Light colour UV-C
Required components:

The UVC LED result tolerance is ± 10 %

PHOTOMETRIC DATA (MEASURED):

OSRAM Opto Semiconductors

LED OSLON UV 3636 (SU CULBN1.VC)
FWHM / FWTM 54.0° / 76.0°
Efficiency 77 %
LEDs/each optic 1
Light colour UV-C
Required components:

The UVC LED result tolerance is ± 10 %

OSRAM Opto Semiconductors

LED OSLON UV 3636 (SU CULDN1.VC)
FWHM / FWTM 57.0° / 79.0°
Efficiency 80 %
LEDs/each optic 1
Light colour UV-C
Required components:

The UVC LED result tolerance is ± 10 %

OSRAM Opto Semiconductors

LED OSLON UV 6060 (SU CZHPF1.VC)
FWHM / FWTM 53.0° / 72.0°
Efficiency 75 %
LEDs/each optic 1
Light colour UV-C
Required components:

The UVC LED result tolerance is ± 10 %

STANLEY

LED ZEUBE265 Series
FWHM / FWTM 43.0° / 63.0°
Efficiency 71 %
LEDs/each optic 1
Light colour UV-C
Required components:

The UVC LED result tolerance is ± 10 %

PHOTOMETRIC DATA (SIMULATED):



LED Bridgelux SMD 5050
 FWHM / FWTM 64.0° / 76.0°
 Efficiency 94 %
 Peak intensity 0.9 cd/lm
 LEDs/each optic 1
 Light colour White
 Required components:

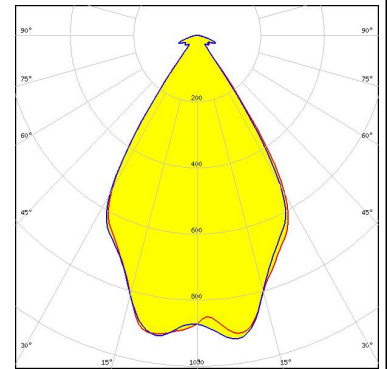

LED XST-3535-UV
 FWHM / FWTM 36.0° / 54.0°
 Efficiency 86 %
 LEDs/each optic 1
 Light colour UV-C
 Required components:

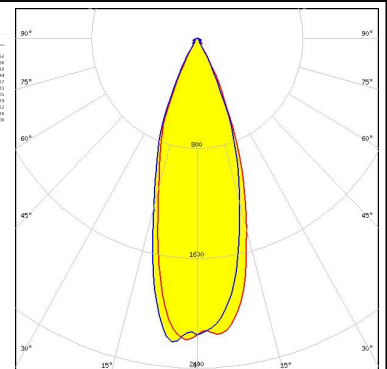
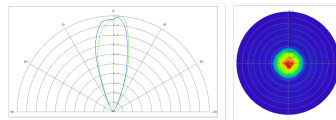

The UVC LED result tolerance is ± 10 %



LED NCSU334A
 FWHM / FWTM 62.4° / 71.6°
 Efficiency 86 %
 LEDs/each optic 1
 Light colour UV-C
 Required components:

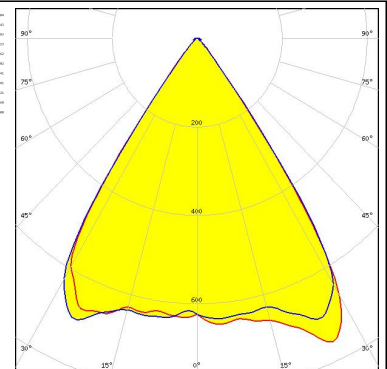
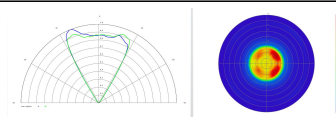

The UVC LED result tolerance is ± 10 %



LED NCSU334B
 FWHM / FWTM 61.0° / 69.0°
 Efficiency 84 %
 LEDs/each optic 1
 Light colour UV-C
 Required components:

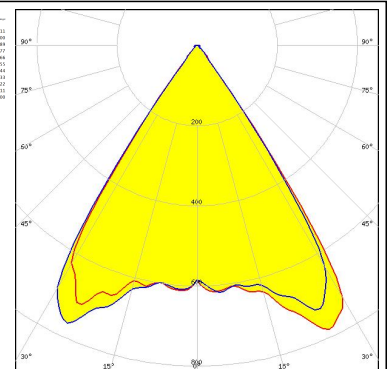
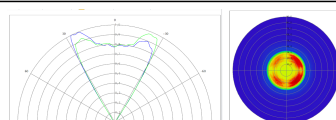

The UVC LED result tolerance is ± 10 %

PHOTOMETRIC DATA (SIMULATED):

NICHIA

LED	NCSU434A
FWHM / FWTM	61.0° / 64.0°
Efficiency	85 %
LEDs/each optic	1
Light colour	UV-C
Required components:	

The UVC LED result tolerance is ±10 %

NICHIA

LED	NVSU233B
FWHM / FWTM	84.0° / 108.0°
Efficiency	98 %
Peak intensity	0.6 cd/lm
LEDs/each optic	1
Light colour	UV-A
Required components:	

NICHIA

LED	NVSU233B-D4
FWHM / FWTM	45.0° / 58.0°
Efficiency	97 %
Peak intensity	2.1 cd/lm
LEDs/each optic	1
Light colour	UV-A
Required components:	

OSRAM
Opto Semiconductors

LED	OSLON UV 3636 (SU CULDN1.VC)
FWHM / FWTM	63.0° / 72.0°
Efficiency	84 %
LEDs/each optic	1
Light colour	UV-C
Required components:	

The UVC LED result tolerance is ±10 %

GENERAL INFORMATION:

NOTE: The typical beam angle will be changed by different color, chip size and chip position tolerance. The typical total beam angle is the full angle measured where the luminous intensity is half of the peak value.

MATERIALS:

As part of our continuous research and improvement processes, and to ensure the best possible quality and availability of our products, LEDiL reserves the right to change material grades without notice.

PRODUCT DATA USER AGREEMENT AND DISCLAIMER:

The measured data in the provided downloadable LEDiL Product Datasheets and Mechanical 2D-Drawings is rounded and provided as reference for planning. LEDiL Oy's optical specifications have been verified by conducting performance testing of the products in accordance with the company's quality system. The reported data are averaged results of multiple measurements with typical variation. LEDiL Oy reserves the right to without prior notification make changes and improvements to its products.

LEDiL Oy assumes neither warranty, nor guarantee nor any other liability of any kind for the contents and correctness of the provided data. The provided data has been generated with highest diligence but the provided data may in reality not represent the complete possible variation range of all intrinsic parameters. Therefore, in certain cases a deviation from the provided data could occur.

LEDiL Oy reserves the right to undertake technical changes of its products without further notification which could lead to changes in the provided data. LEDiL Oy assumes no liability of any kind for the possible deviation from any provided data or any other damage resulting from the usage of the provided data.

The user agrees to this disclaimer and user agreement with the download or usage of the provided files.

LEDiL Oy

Joensuunkatu 13
FI-24240 SALO
Finland

LEDiL Inc.

228 West Page Street
Suite D
Sycamore IL 60178
USA

Ledil Optics Technology (Shenzhen) Co., Ltd.

405 , Block B
Casic Motor Building
Shenzhen 518057
P.R.CHINA

Local sales and technical support

[www.ledil.com/
where_to_buy](http://www.ledil.com/where_to_buy)

Shipping locations

Salo, Finland
Hong Kong, China

Distribution Partners

[www.ledil.com/
where_to_buy](http://www.ledil.com/where_to_buy)

X-ON Electronics

Largest Supplier of Electrical and Electronic Components

Click to view similar products for [LED Lighting Lenses](#) category:

Click to view products by [Ledil](#) manufacturer:

Other Similar products are found below :

[LL01ED-AK40L06](#) [LL01ZZ-EX25L06-M2](#) [180182-0000](#) [LL01ED-ALI55R49](#) [C14707_IDA16-O](#) [LL01ED-AKY24R49](#) [LL01CR-AYG15R49](#) [LL01CR-OT32L06-M2](#) [LL01ZZ-AAA24L49](#) [LL01CR-CEN38L02](#) [LL01ZZ-AAA55L49](#) [LL01CR-AYG24R49](#)
[LL01A00CZMB2-M2](#) [LL01ED-AKY38R49](#) [LL01CR-CNE2545L06-M2](#) [LL01ZZ-AAA38L49](#) [LL01ED-AKV36R49](#) [LL01ED-ALI24R49](#)
[LL01CR-AYG38R49](#) [C17171_DAISSY-8X1-SHD-MATT](#) [F16859_LINDA-ZT25](#) [C17295_ILONA-ZOOM](#) [F16636_LINDA-W60](#)
[C16871_DAISSY-7X1-W](#) [C18165_AMY-35-ZOOM-SUB](#) [10003](#) [10003/15](#) [10048](#) [10049](#) [10108](#) [F14487_FLORENCE-1R-MAXI-WG](#) [12667](#)
[C14605_HB-2X2-RW](#) [C14642_FLORENCE-1R-UP](#) [CAY033](#) [CAY046/55](#) [OS-LRI2015X45S](#) [OSOLRA2015M](#) [PG1C-NX36](#) [PG1C-SX17](#)
[PM2A-SXV1](#) [PM2B-NX55-AW](#) [PM6A-FN25](#) [FC2231-0000-0050-L](#) [FC2231-0000-0100-L](#) [C14116_STRADA-2X2-PX](#) [C12345_HB-5X1-W](#)
[95-0931](#) [C15800_MOLLY-S](#) [C15802_MOLLY-W](#)