

TINA-RS

~13° spot beam optimized for Nichia NS6x83.
Assembly with holder and installation tape.

TECHNICAL SPECIFICATIONS:

Dimensions	Ø 16.1 mm
Height	11.1 mm
Fastening	tape
ROHS compliant	yes ⓘ



MATERIAL SPECIFICATIONS:

Component	Type	Material	Colour	Finish
TINA-RS	Single lens	PMMA	clear	
TINA-N83-H-TAPE-WHT	Holder	PC	white	
TINA-TAPE3	Tape	Acrylic foam	black	

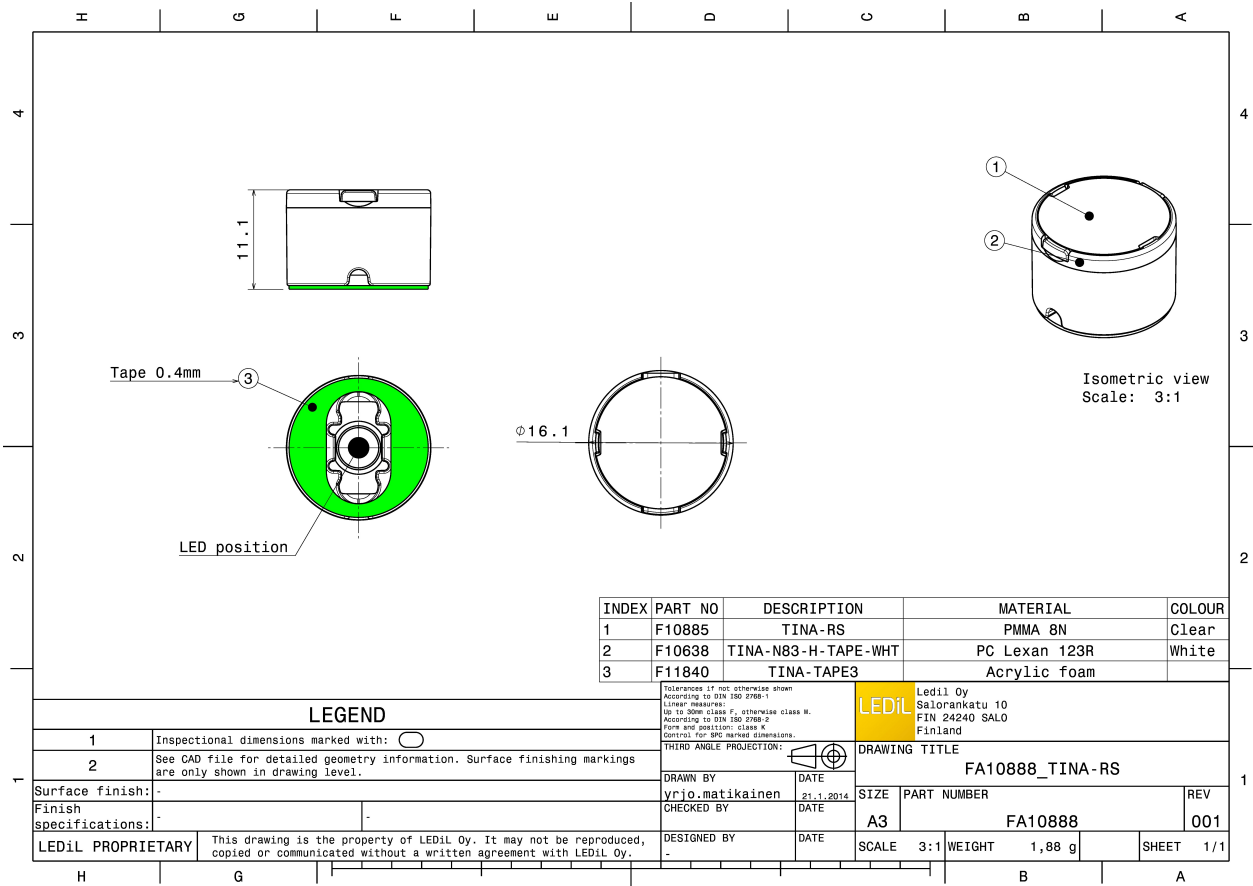

ORDERING INFORMATION:

Component		Qty in box	MOQ	MPQ	Box weight (kg)
FA10888_TINA-RS	Single lens	2016	288	144	4.1
» Box size: 470 x 240 x 105 mm					

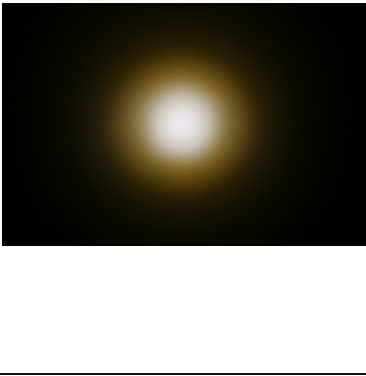
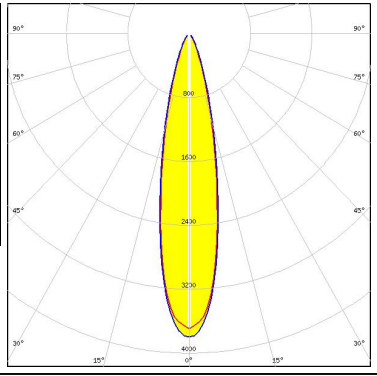
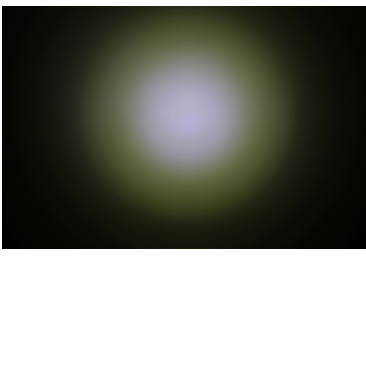
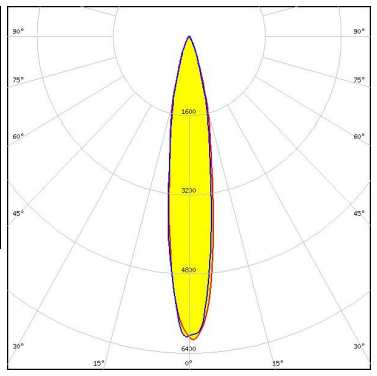

See also our general installation guide: www.ledil.com/installation_guide

PHOTOMETRIC DATA (MEASURED):

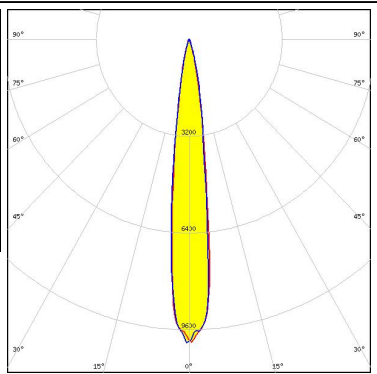
<p>CREE LED</p> <p>LED: MX-6 FWHM / FWTM: 14.0° / 36.0° Efficiency: 93 % Peak intensity: 7.7 cd/lm LEDs/each optic: 1 Light colour: White Required components:</p>		
<p>NICHIA</p> <p>LED: NS6x83 FWHM / FWTM: 17.0° / 39.0° Efficiency: 94 % Peak intensity: 6.2 cd/lm LEDs/each optic: 1 Light colour: White Required components:</p>		
<p>TOSHIBA <small>Leading Innovation >>></small></p> <p>LED: TL1L4 FWHM / FWTM: 13.0° / 28.0° Efficiency: 90 % Peak intensity: 10 cd/lm LEDs/each optic: 1 Light colour: White Required components:</p>		

PHOTOMETRIC DATA (SIMULATED):

<p>CREE ⇄ LED</p> <p>LED: XP-E2 FWHM / FWTM: 10.0° / 20.0° Efficiency: 92 % Peak intensity: 22.6 cd/lm LEDs/each optic: 1 Light colour: White Required components:</p>	
<p>CREE ⇄ LED</p> <p>LED: XP-G2 FWHM / FWTM: 14.0° / 25.0° Efficiency: 92 % Peak intensity: 13.1 cd/lm LEDs/each optic: 1 Light colour: White Required components:</p>	
<p>CREE ⇄ LED</p> <p>LED: XP-G3 FWHM / FWTM: 16.0° / 32.0° Efficiency: 89 % Peak intensity: 8 cd/lm LEDs/each optic: 1 Light colour: White Required components:</p>	
<p>CREE ⇄ LED</p> <p>LED: XP-L HI FWHM / FWTM: 14.0° / 26.0° Efficiency: 93 % Peak intensity: 11.6 cd/lm LEDs/each optic: 1 Light colour: White Required components:</p>	

PHOTOMETRIC DATA (SIMULATED):



LED XT-E
FWHM / FWTM 12.0° / 24.0°
Efficiency 86 %
Peak intensity 12.1 cd/lm
LEDs/each optic 1
Light colour White
Required components:

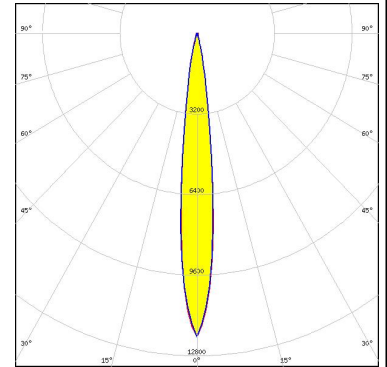

LED OSLO Black
FWHM / FWTM 10.0° / 20.0°
Efficiency 89 %
Peak intensity 20.4 cd/lm
LEDs/each optic 1
Light colour White
Required components:

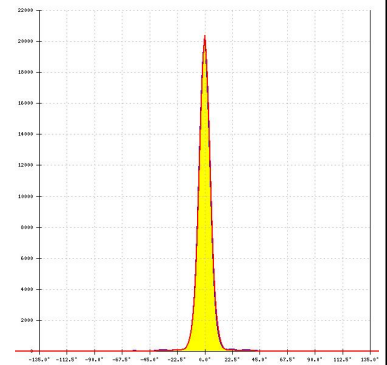

LED SFH 4716AS
FWHM / FWTM 11.0° / 21.0°
Efficiency 90 %
Peak intensity 17.7 cd/lm
LEDs/each optic 1
Light colour White
Required components:

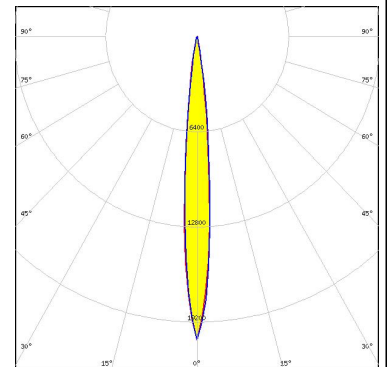

LED LH351C
FWHM / FWTM 18.0° / 32.0°
Efficiency 94 %
Peak intensity 8.1 cd/lm
LEDs/each optic 1
Light colour White
Required components:

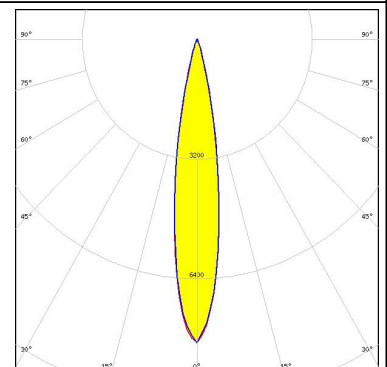

GENERAL INFORMATION:

NOTE: The typical beam angle will be changed by different color, chip size and chip position tolerance. The typical total beam angle is the full angle measured where the luminous intensity is half of the peak value.

MATERIALS:

As part of our continuous research and improvement processes, and to ensure the best possible quality and availability of our products, LEDiL reserves the right to change material grades without notice.

PRODUCT DATA USER AGREEMENT AND DISCLAIMER:

The measured data in the provided downloadable LEDiL Product Datasheets and Mechanical 2D-Drawings is rounded and provided as reference for planning. LEDiL Oy's optical specifications have been verified by conducting performance testing of the products in accordance with the company's quality system. The reported data are averaged results of multiple measurements with typical variation. LEDiL Oy reserves the right to without prior notification make changes and improvements to its products.

LEDiL Oy assumes neither warranty, nor guarantee nor any other liability of any kind for the contents and correctness of the provided data. The provided data has been generated with highest diligence but the provided data may in reality not represent the complete possible variation range of all intrinsic parameters. Therefore, in certain cases a deviation from the provided data could occur.

LEDiL Oy reserves the right to undertake technical changes of its products without further notification which could lead to changes in the provided data. LEDiL Oy assumes no liability of any kind for the possible deviation from any provided data or any other damage resulting from the usage of the provided data.

The user agrees to this disclaimer and user agreement with the download or usage of the provided files.

LEDiL Oy

Joensuunkatu 13
FI-24240 SALO
Finland

LEDiL Inc.

228 West Page Street
Suite D
Sycamore IL 60178
USA

Ledil Optics Technology (Shenzhen) Co., Ltd.

405 , Block B
Casic Motor Building
Shenzhen 518057
P.R.CHINA

Local sales and technical support

[www.ledil.com/
where_to_buy](http://www.ledil.com/where_to_buy)

Shipping locations

Salo, Finland
Hong Kong, China

Distribution Partners

[www.ledil.com/
where_to_buy](http://www.ledil.com/where_to_buy)

X-ON Electronics

Largest Supplier of Electrical and Electronic Components

Click to view similar products for [LED Lighting Lenses Assemblies](#) category:

Click to view products by [Ledil](#) manufacturer:

Other Similar products are found below :

[FCN12592_LE1-D-COP](#) [CA16129_OLGA-W](#) [CA16370_HB-SQ-W](#) [FN15972_RONDA-ZT45-C](#) [CS15759_HB-2X2MX-8-W](#)
[CA16435_LXP2-SS-WAS](#) [CN16210_GABRIELLA-MIDI-W](#) [CP17137_CARMEN-M2-C](#) [CA16015_STRADA-SQ-SCL](#) [CP17594_TINA-SC-](#)
[RS](#) [CS15767_HB-2X2MX-8-M](#) [CP10960_RGBX-SS](#) [CP12395_LXP3-W](#) [CP12939_LARISA-RS-CLIP16](#) [C14636_XTM-PF-ADAPTER](#)
[CA11819_STRADA-SQ-T-DW](#) [CA14508_G2-LXP2-D](#) [CA14601_VERONICA-SQ-MINI-RS](#) [FCP13895_SEANNA-A](#) [CP12943_LARISA-](#)
[O-CLIP16](#) [FP11124_LISA2-O-PIN](#) [CS14597_HB-IP-2X6-O](#) [CP14995_FLORENTINA-HLD-O](#) [CS15158_STRADA-IP-2X6-T4-B](#)
[CS16323_STRADELLA-IP-28-HB-M](#) [FN14976_STELLA-DWC2](#) [FN15264_STELLA-HB-WWW](#) [CA15584_ZORYA-MINI-TAPE](#)
[FA15229_ROSE-MRK-S](#) [FA15232_ROSE-MRK-M](#) [FA15233_ROSE-MRK-W](#) [FCN13552_CRYSTAL-RS](#) [FN15552_RONDA-W](#)
[FS15626_FLORENCE-3R-IP-Z90](#) [FS15786_FLORENCE-3R-IP-Z60](#) [FS15847_FLORENCE-3R-IP-O](#) [CA14505_G2-LXP2-RS2-P](#)
[FCN12775_IRIS-O](#) [CP15304_LARISA-RS-PIN](#) [FN15679_RONDA-S](#) [CA15519_VERONICA-SQ-MINI-D](#) [FP14414_LISA2-O-PIN](#)
[LL01CR-DF60L06-M2](#) [FN15993_RONDA-O](#) [FN15977_RONDA-WAS2](#) [CA14366_FLARE-MAXI-TAPE](#) [CA14442_VERONICA-SQ-W](#)
[CA14509_G2-LXP2-M-P](#) [CA15231_VERONICA-SQ-MINI-W](#) [FP11002_LISA2-W-PIN](#)