

IRIS

~5° real spot beam optimized for CREE XM-L.
Assembly with holder and installation tape.

TECHNICAL SPECIFICATIONS:

Dimensions	Ø 38.0 mm
Height	27.7 mm
Fastening	tape, pin, screw
ROHS compliant	yes ⓘ

MATERIAL SPECIFICATIONS:

Component	Type	Material	Colour	Finish
IRIS	Single lens	PMMA	clear	
IRIS-XM-HLD	Holder	PC	black	
SPUTNIK-TAPE	Tape	Acrylic foam	black	



ORDERING INFORMATION:

Component	Type	Qty in box	MOQ	MPQ	Box weight (kg)
FCA12104_IRIS	Single lens	378	126	42	9.0
» Box size: 480 x 280 x 300 mm					

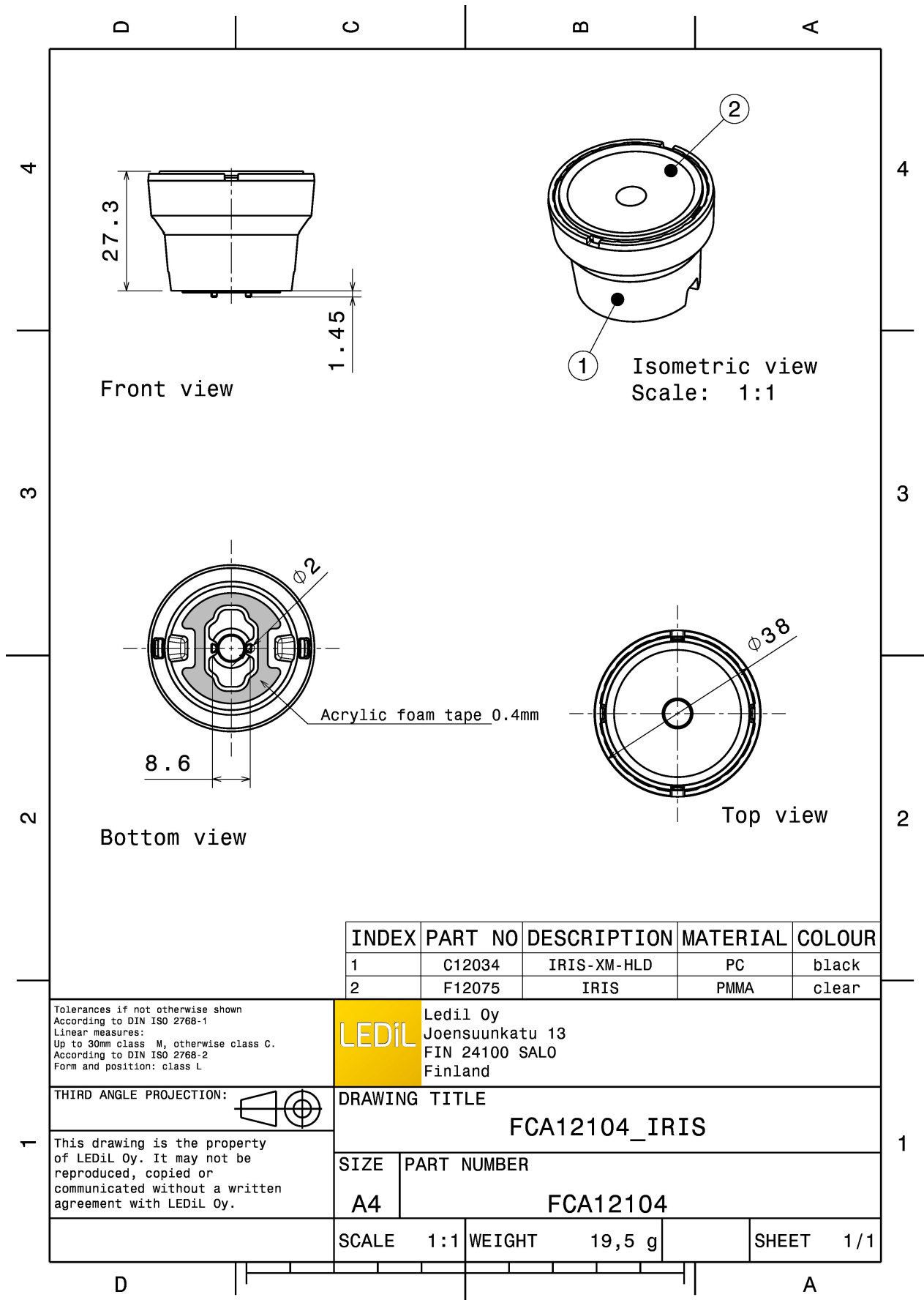

INDEX	PART NO	DESCRIPTION	MATERIAL	COLOUR
1	C12034	IRIS-XM-HLD	PC	black
2	F12075	IRIS	PMMA	clear

Tolerances if not otherwise shown
According to DIN ISO 2768-1
Linear measures:
Up to 30mm class M, otherwise class C.
According to DIN ISO 2768-2
Form and position: class L

LEDiL Ledil Oy
Joensuunkatu 13
FIN 24100 SALO
Finland

THIRD ANGLE PROJECTION:

DRAWING TITLE
FCA12104_IRIS







This drawing is the property of LEDiL Oy. It may not be reproduced, copied or communicated without a written agreement with LEDiL Oy.

SIZE	PART NUMBER
A4	FCA12104

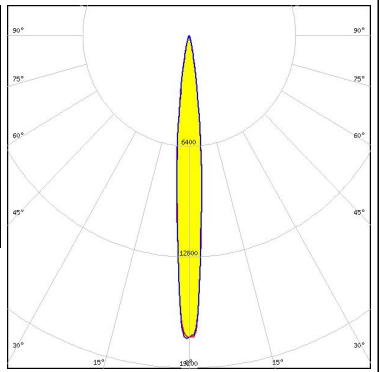
SCALE	1:1	WEIGHT	19,5 g	SHEET	1/1
-------	-----	--------	--------	-------	-----

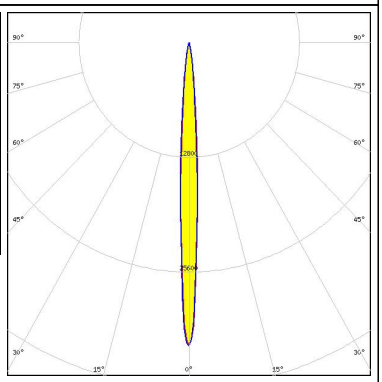
See also our general installation guide: www.ledil.com/installation_guide

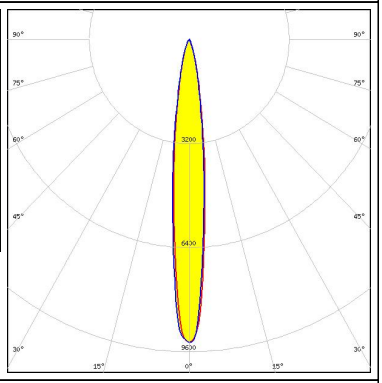
PHOTOMETRIC DATA (MEASURED):

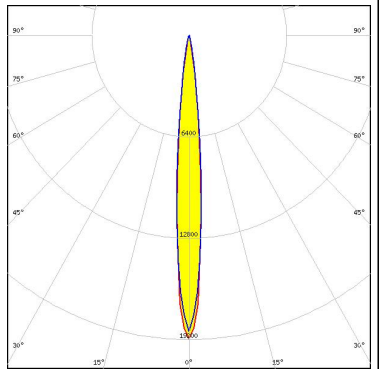
<p>CREE → LED</p> <p>LED XHP35 HD FWHM / FWTM 10.0° / 22.0° Efficiency 91 % Peak intensity 17.5 cd/lm LEDs/each optic 1 Light colour White Required components:</p>		
<p>CREE → LED</p> <p>LED XHP35 HI FWHM / FWTM 7.0° / 16.0° Efficiency 93 % Peak intensity 33.8 cd/lm LEDs/each optic 1 Light colour White Required components:</p>		
<p>CREE → LED</p> <p>LED XHP50.2 FWHM / FWTM 12.0° / 30.0° Efficiency 88 % Peak intensity 9.3 cd/lm LEDs/each optic 1 Light colour White Required components:</p>		
<p>CREE → LED</p> <p>LED XM-L FWHM / FWTM 9.0° / 19.0° Efficiency 91 % Peak intensity 19.2 cd/lm LEDs/each optic 1 Light colour White Required components:</p>		

PHOTOMETRIC DATA (MEASURED):



LED XM-L2
 FWHM / FWTM 10.0° / 23.0°
 Efficiency 86 %
 Peak intensity 18.1 cd/lm
 LEDs/each optic 1
 Light colour White
 Required components:

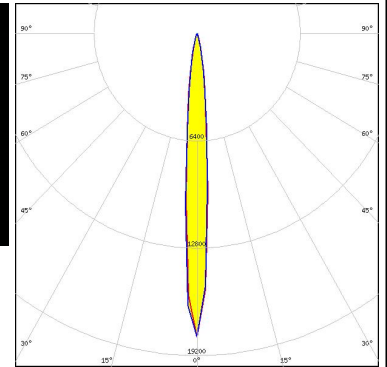

LED NV4x144A
 FWHM / FWTM 13.0° / 31.0°
 Efficiency 89 %
 Peak intensity 9.3 cd/lm
 LEDs/each optic 1
 Light colour White
 Required components:

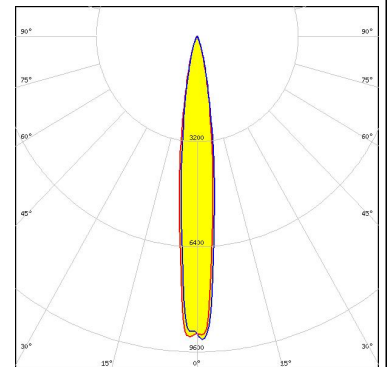

LED NVSW3x9A
 FWHM / FWTM 7.0° / 17.0°
 Efficiency 85 %
 Peak intensity 25.5 cd/lm
 LEDs/each optic 1
 Light colour White
 Required components:

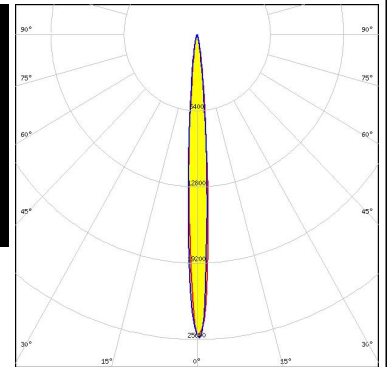
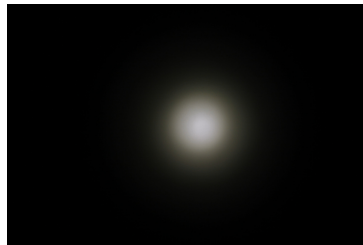

LED OSCONIQ P 3737 (2W version)
 FWHM / FWTM 5.0° / 14.0°
 Efficiency 91 %
 Peak intensity 38.8 cd/lm
 LEDs/each optic 1
 Light colour White
 Required components:

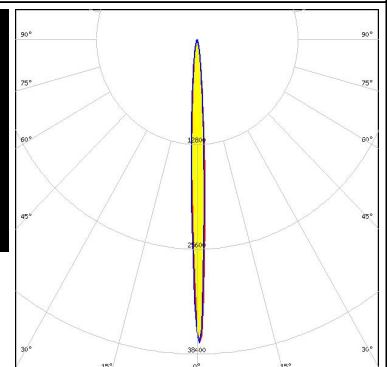
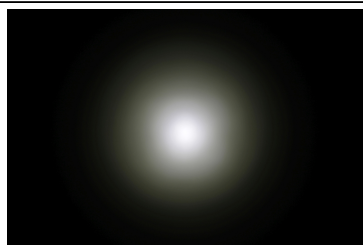

PHOTOMETRIC DATA (SIMULATED):

<p>CREE → LED</p> <p>LED: XD16 FWHM / FWTM: 6.0° / 14.0° Efficiency: 91 % Peak intensity: 47.7 cd/lm LEDs/each optic: 1 Light colour: White Required components:</p>	
<p>CREE → LED</p> <p>LED: XHP35.2 FWHM / FWTM: 8.0° / 20.0° Efficiency: 85 % Peak intensity: 21.1 cd/lm LEDs/each optic: 1 Light colour: White Required components:</p>	
<p>CREE → LED</p> <p>LED: XHP50.3 HD FWHM / FWTM: 13.0° / 28.0° Efficiency: 89 % Peak intensity: 10.9 cd/lm LEDs/each optic: 1 Light colour: White Required components:</p>	
<p>CREE → LED</p> <p>LED: XHP50.3 HI FWHM / FWTM: 10.0° / 22.0° Efficiency: 96 % Peak intensity: 17 cd/lm LEDs/each optic: 1 Light colour: White Required components:</p>	

PHOTOMETRIC DATA (SIMULATED):



LED XP-L HD
FWHM / FWTM 8.8° / 19.0°
Efficiency 93 %
Peak intensity 24.7 cd/lm
LEDs/each optic 1
Light colour White
Required components:

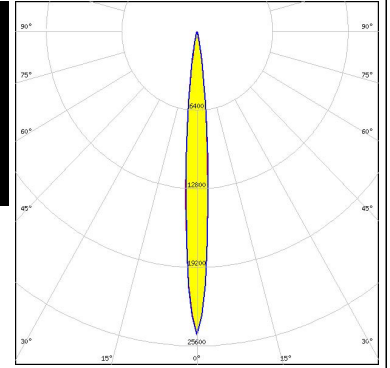

LED Duris S8
FWHM / FWTM 12.0° / 30.0°
Efficiency 92 %
Peak intensity 10.3 cd/lm
LEDs/each optic 1
Light colour White
Required components:

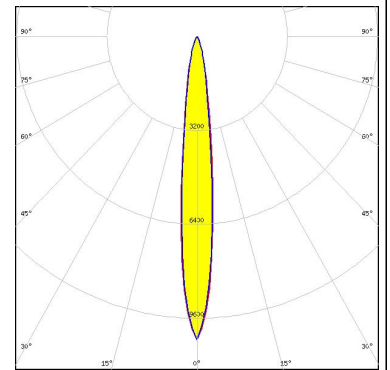

GENERAL INFORMATION:

NOTE: The typical beam angle will be changed by different color, chip size and chip position tolerance. The typical total beam angle is the full angle measured where the luminous intensity is half of the peak value.

MATERIALS:

As part of our continuous research and improvement processes, and to ensure the best possible quality and availability of our products, LEDiL reserves the right to change material grades without notice.

PRODUCT DATA USER AGREEMENT AND DISCLAIMER:

The measured data in the provided downloadable LEDiL Product Datasheets and Mechanical 2D-Drawings is rounded and provided as reference for planning. LEDiL Oy's optical specifications have been verified by conducting performance testing of the products in accordance with the company's quality system. The reported data are averaged results of multiple measurements with typical variation. LEDiL Oy reserves the right to without prior notification make changes and improvements to its products.

LEDiL Oy assumes neither warranty, nor guarantee nor any other liability of any kind for the contents and correctness of the provided data. The provided data has been generated with highest diligence but the provided data may in reality not represent the complete possible variation range of all intrinsic parameters. Therefore, in certain cases a deviation from the provided data could occur.

LEDiL Oy reserves the right to undertake technical changes of its products without further notification which could lead to changes in the provided data. LEDiL Oy assumes no liability of any kind for the possible deviation from any provided data or any other damage resulting from the usage of the provided data.

The user agrees to this disclaimer and user agreement with the download or usage of the provided files.

LEDiL Oy

Joensuunkatu 13
FI-24240 SALO
Finland

LEDiL Inc.

228 West Page Street
Suite D
Sycamore IL 60178
USA

Ledil Optics Technology (Shenzhen) Co., Ltd.

405 , Block B
Casic Motor Building
Shenzhen 518057
P.R.CHINA

Local sales and technical support

[www.ledil.com/
where_to_buy](http://www.ledil.com/where_to_buy)

Shipping locations

Salo, Finland
Hong Kong, China

Distribution Partners

[www.ledil.com/
where_to_buy](http://www.ledil.com/where_to_buy)

X-ON Electronics

Largest Supplier of Electrical and Electronic Components

Click to view similar products for [LED Lighting Lenses Assemblies](#) category:

Click to view products by [Ledil](#) manufacturer:

Other Similar products are found below :

[FCN12592_LE1-D-COP](#) [CA16129_OLGA-W](#) [CA16370_HB-SQ-W](#) [FN15972_RONDA-ZT45-C](#) [CS15759_HB-2X2MX-8-W](#)
[CA16435_LXP2-SS-WAS](#) [CN16210_GABRIELLA-MIDI-W](#) [CP17137_CARMEN-M2-C](#) [CA16015_STRADA-SQ-SCL](#) [CP17594_TINA-SC-](#)
[RS](#) [CS15767_HB-2X2MX-8-M](#) [CP10960_RGBX-SS](#) [CP12395_LXP3-W](#) [CP12939_LARISA-RS-CLIP16](#) [C14636_XTM-PF-ADAPTER](#)
[CA11819_STRADA-SQ-T-DW](#) [CA14508_G2-LXP2-D](#) [CA14601_VERONICA-SQ-MINI-RS](#) [FCP13895_SEANNA-A](#) [CP12943_LARISA-](#)
[O-CLIP16](#) [FP11124_LISA2-O-PIN](#) [CS14597_HB-IP-2X6-O](#) [CP14995_FLORENTINA-HLD-O](#) [CS15158_STRADA-IP-2X6-T4-B](#)
[CS16323_STRADELLA-IP-28-HB-M](#) [FN14976_STELLA-DWC2](#) [FN15264_STELLA-HB-WWW](#) [CA15584_ZORYA-MINI-TAPE](#)
[FA15229_ROSE-MRK-S](#) [FA15232_ROSE-MRK-M](#) [FA15233_ROSE-MRK-W](#) [FCN13552_CRYSTAL-RS](#) [FN15552_RONDA-W](#)
[FS15626_FLORENCE-3R-IP-Z90](#) [FS15786_FLORENCE-3R-IP-Z60](#) [FS15847_FLORENCE-3R-IP-O](#) [CA14505_G2-LXP2-RS2-P](#)
[FCN12775_IRIS-O](#) [CP15304_LARISA-RS-PIN](#) [FN15679_RONDA-S](#) [CA15519_VERONICA-SQ-MINI-D](#) [FP14414_LISA2-O-PIN](#)
[LL01CR-DF60L06-M2](#) [FN15993_RONDA-O](#) [FN15977_RONDA-WAS2](#) [CA14366_FLARE-MAXI-TAPE](#) [CA14442_VERONICA-SQ-W](#)
[CA14509_G2-LXP2-M-P](#) [CA15231_VERONICA-SQ-MINI-W](#) [FP11002_LISA2-W-PIN](#)