

G2-ROSE-UV-M

~25° medium beam. Assembly with black holder and installation tape.

TECHNICAL SPECIFICATIONS:

Dimensions	21.6 x 21.6 mm
Height	12.9 mm
Fastening	tape, pin
ROHS compliant	yes ⓘ

MATERIAL SPECIFICATIONS:

Component	Type	Material	Colour	Finish
G2-ROSE-UV-M	Single lens	Silicone	clear	
G2-ROSE-LT-HLD	Holder	PC	black	
ROSE-TAPE	Tape	Acrylic foam	black	

ORDERING INFORMATION:



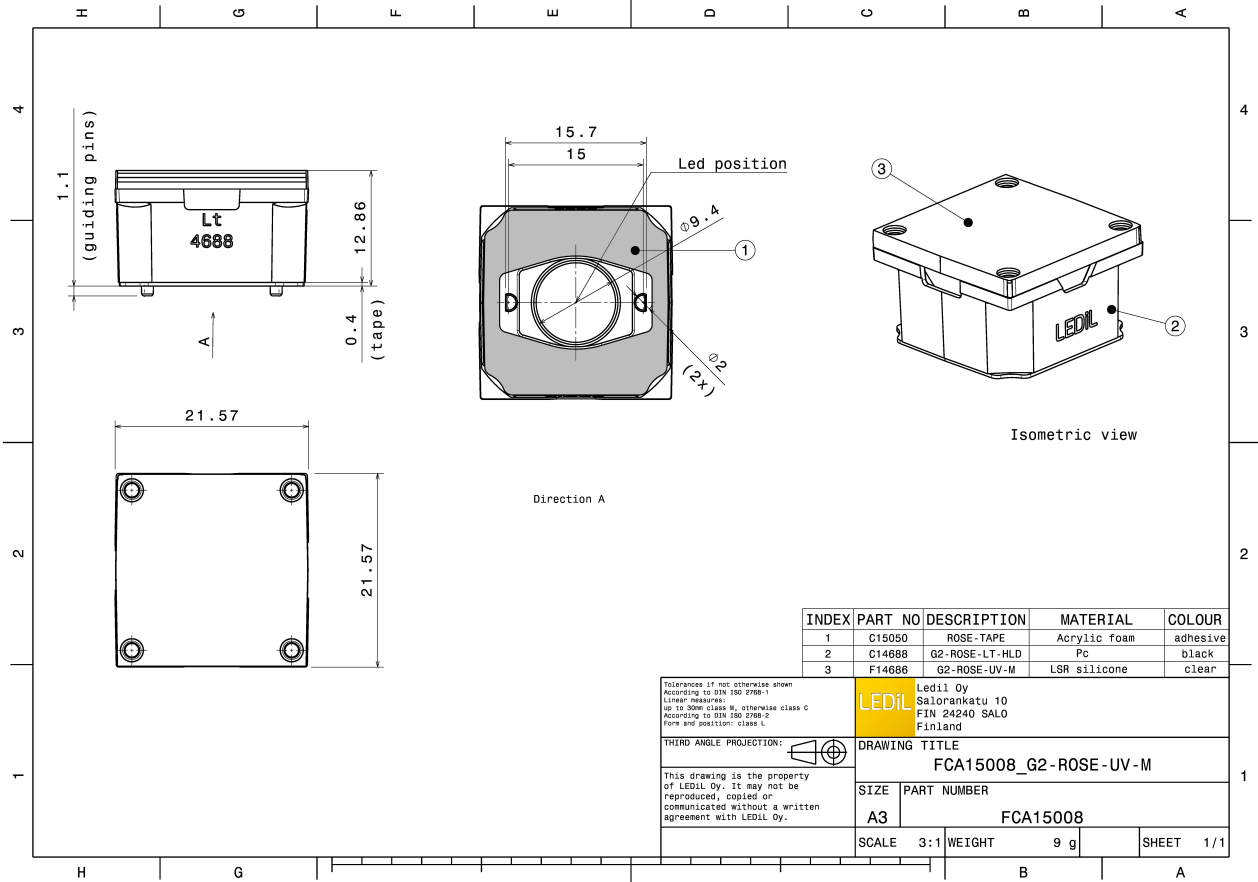

Component	Type	Qty in box	MOQ	MPQ	Box weight (kg)
FCA15008_G2-ROSE-UV-M » Box size: 476 x 273 x 197 mm	Single lens	1620	360	180	6.7







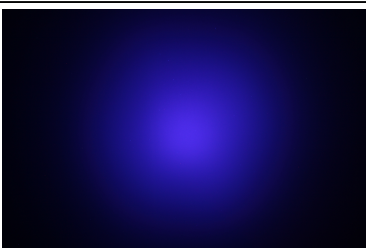

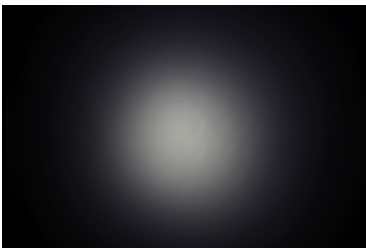

See also our general installation guide: www.ledil.com/installation_guide

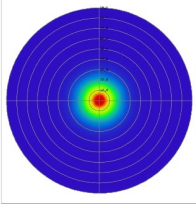
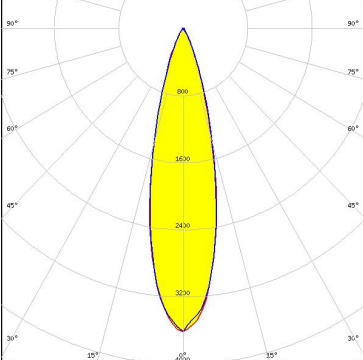
PHOTOMETRIC DATA (MEASURED):

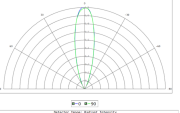
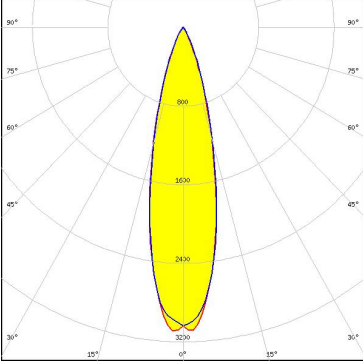
 <p>LED LZ1-00UV00 FWHM / FWTM 26.0° / 52.0° Efficiency % LEDs/each optic 1 Light colour UV-A Required components:</p>	
 <p>LED SST-10-B130 FWHM / FWTM 18.0° / 44.0° Efficiency % LEDs/each optic 1 Light colour UV-A Required components:</p>	
 <p>LED NVSU233A FWHM / FWTM 23.0° / 48.0° Efficiency % LEDs/each optic 1 Light colour UV-A Required components:</p>	
 <p>LED NVSW319B FWHM / FWTM 22.0° / 47.0° Efficiency 87 % Peak intensity 3.7 cd/m LEDs/each optic 1 Light colour UV-A Required components:</p>	

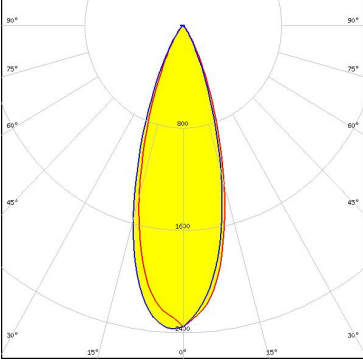
PHOTOMETRIC DATA (SIMULATED):

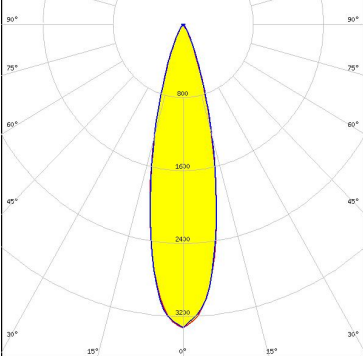
	<p>LED NVSU119C FWHM / FWTM 24.0° / 47.0° Efficiency 89 % LEDs/each optic 1 Light colour UV-A Required components:</p>	 <p>Detector: Edge; Intensity: Intensity</p> <p>27.5.2019 Director: J. KOC, Software: 11 Max. order angle: 90.00 deg; Total LEDs = 4482244 Peak Intensity: 3.6171000; Lumens/Emission: Total Power: 1.8871444; Labels:</p>	
	<p>LED NVSU119C FWHM / FWTM 26.0° / 49.0° Efficiency 78 % LEDs/each optic 1 Light colour UV-A Required components:</p>		
	<p>LED NVSU233A FWHM / FWTM 33.0° / 59.0° Efficiency 87 % Peak intensity 2.4 cd/lm LEDs/each optic 1 Light colour White Required components:</p>		
	<p>LED NVSxx19B/NVSxx19C FWHM / FWTM 26.0° / 50.0° Efficiency 82 % Peak intensity 3.3 cd/lm LEDs/each optic 1 Light colour UV-A Required components:</p>		

PHOTOMETRIC DATA (SIMULATED):

<p>SEOL SEOUL SEMICONDUCTOR</p> <p>LED CUN66B1G FWHM / FWTM 29.0° / 54.0° Efficiency 73 % LEDs/each optic 1 Light colour UV-A Required components:</p>	
<p>SEOL SEOUL SEMICONDUCTOR</p> <p>LED WICOP DY9560-27 FWHM / FWTM 40.0° / 81.0° Efficiency 40 % LEDs/each optic 24 Light colour UV-C Required components:</p> <p>The UVC LED result tolerance is ± 10 %</p>	
<p>SEOL SEOUL SEMICONDUCTOR</p> <p>LED WICOP DY9560-27 FWHM / FWTM 29.0° / 56.0° Efficiency 50 % LEDs/each optic 4 Light colour UV-C Required components:</p> <p>The UVC LED result tolerance is ± 10 %</p>	
<p>SEOL SEOUL SEMICONDUCTOR</p> <p>LED WICOP DY9560-27 FWHM / FWTM 25.0° / 49.0° Efficiency 51 % LEDs/each optic 1 Light colour UV-C Required components:</p> <p>The UVC LED result tolerance is ± 10 %</p>	

GENERAL INFORMATION:

NOTE: The typical beam angle will be changed by different color, chip size and chip position tolerance. The typical total beam angle is the full angle measured where the luminous intensity is half of the peak value.

MATERIALS:

As part of our continuous research and improvement processes, and to ensure the best possible quality and availability of our products, LEDiL reserves the right to change material grades without notice.

PRODUCT DATA USER AGREEMENT AND DISCLAIMER:

The measured data in the provided downloadable LEDiL Product Datasheets and Mechanical 2D-Drawings is rounded and provided as reference for planning. LEDiL Oy's optical specifications have been verified by conducting performance testing of the products in accordance with the company's quality system. The reported data are averaged results of multiple measurements with typical variation. LEDiL Oy reserves the right to without prior notification make changes and improvements to its products.

LEDiL Oy assumes neither warranty, nor guarantee nor any other liability of any kind for the contents and correctness of the provided data. The provided data has been generated with highest diligence but the provided data may in reality not represent the complete possible variation range of all intrinsic parameters. Therefore, in certain cases a deviation from the provided data could occur.

LEDiL Oy reserves the right to undertake technical changes of its products without further notification which could lead to changes in the provided data. LEDiL Oy assumes no liability of any kind for the possible deviation from any provided data or any other damage resulting from the usage of the provided data.

The user agrees to this disclaimer and user agreement with the download or usage of the provided files.

LEDiL Oy

Joensuunkatu 13
FI-24240 SALO
Finland

LEDiL Inc.

228 West Page Street
Suite D
Sycamore IL 60178
USA

Ledil Optics Technology (Shenzhen) Co., Ltd.

405 , Block B
Casic Motor Building
Shenzhen 518057
P.R.CHINA

Local sales and technical support

[www.ledil.com/
where_to_buy](http://www.ledil.com/where_to_buy)

Shipping locations

Salo, Finland
Hong Kong, China

Distribution Partners

[www.ledil.com/
where_to_buy](http://www.ledil.com/where_to_buy)

X-ON Electronics

Largest Supplier of Electrical and Electronic Components

Click to view similar products for [LED Lighting Lenses Assemblies](#) category:

Click to view products by [Ledil](#) manufacturer:

Other Similar products are found below :

[FCN12592_LE1-D-COP](#) [CA16129_OLGA-W](#) [CA16370_HB-SQ-W](#) [FN15972_RONDA-ZT45-C](#) [CS15759_HB-2X2MX-8-W](#)
[CA16435_LXP2-SS-WAS](#) [CN16210_GABRIELLA-MIDI-W](#) [CP17137_CARMEN-M2-C](#) [CA16015_STRADA-SQ-SCL](#) [CP17594_TINA-SC-](#)
[RS](#) [CS15767_HB-2X2MX-8-M](#) [CP10960_RGBX-SS](#) [CP12395_LXP3-W](#) [CP12939_LARISA-RS-CLIP16](#) [C14636_XTM-PF-ADAPTER](#)
[CA11819_STRADA-SQ-T-DW](#) [CA14508_G2-LXP2-D](#) [CA14601_VERONICA-SQ-MINI-RS](#) [FCP13895_SEANNA-A](#) [CP12943_LARISA-](#)
[O-CLIP16](#) [FP11124_LISA2-O-PIN](#) [CS14597_HB-IP-2X6-O](#) [CP14995_FLORENTINA-HLD-O](#) [CS15158_STRADA-IP-2X6-T4-B](#)
[CS16323_STRADELLA-IP-28-HB-M](#) [FN14976_STELLA-DWC2](#) [FN15264_STELLA-HB-WWW](#) [CA15584_ZORYA-MINI-TAPE](#)
[FA15229_ROSE-MRK-S](#) [FA15232_ROSE-MRK-M](#) [FA15233_ROSE-MRK-W](#) [FCN13552_CRYSTAL-RS](#) [FN15552_RONDA-W](#)
[FS15626_FLORENCE-3R-IP-Z90](#) [FS15786_FLORENCE-3R-IP-Z60](#) [FS15847_FLORENCE-3R-IP-O](#) [CA14505_G2-LXP2-RS2-P](#)
[FCN12775_IRIS-O](#) [CP15304_LARISA-RS-PIN](#) [FN15679_RONDA-S](#) [CA15519_VERONICA-SQ-MINI-D](#) [FP14414_LISA2-O-PIN](#)
[LL01CR-DF60L06-M2](#) [FN15993_RONDA-O](#) [FN15977_RONDA-WAS2](#) [CA14366_FLARE-MAXI-TAPE](#) [CA14392_LXP2-O-WAS](#)
[CA14442_VERONICA-SQ-W](#) [CA14509_G2-LXP2-M-P](#) [CA15231_VERONICA-SQ-MINI-W](#)