

## SEANNA-A

~2.3° spot beam. Assembly with holder.

### TECHNICAL SPECIFICATIONS:

Dimensions	Ø 155.2 mm
Height	82 mm
Fastening	pin, screw
ROHS compliant	yes ⓘ

### MATERIAL SPECIFICATIONS:

Component	Type	Material	Colour	Finish
SEANNA-A	Single lens	PMMA	clear	
SEANNA-FRES	Single lens	PMMA	clear	
SEANNA-HLD-B	Holder	PA66GF30	black	
SEANNA-HLD-B-TOPRING	Holder	PA66GF30	black	
SEANNA-HLD-B-BOTTOMRING	Holder	PA66GF30	black	
SEANNA-SCREW	Accessory	Stainless steel	clear	





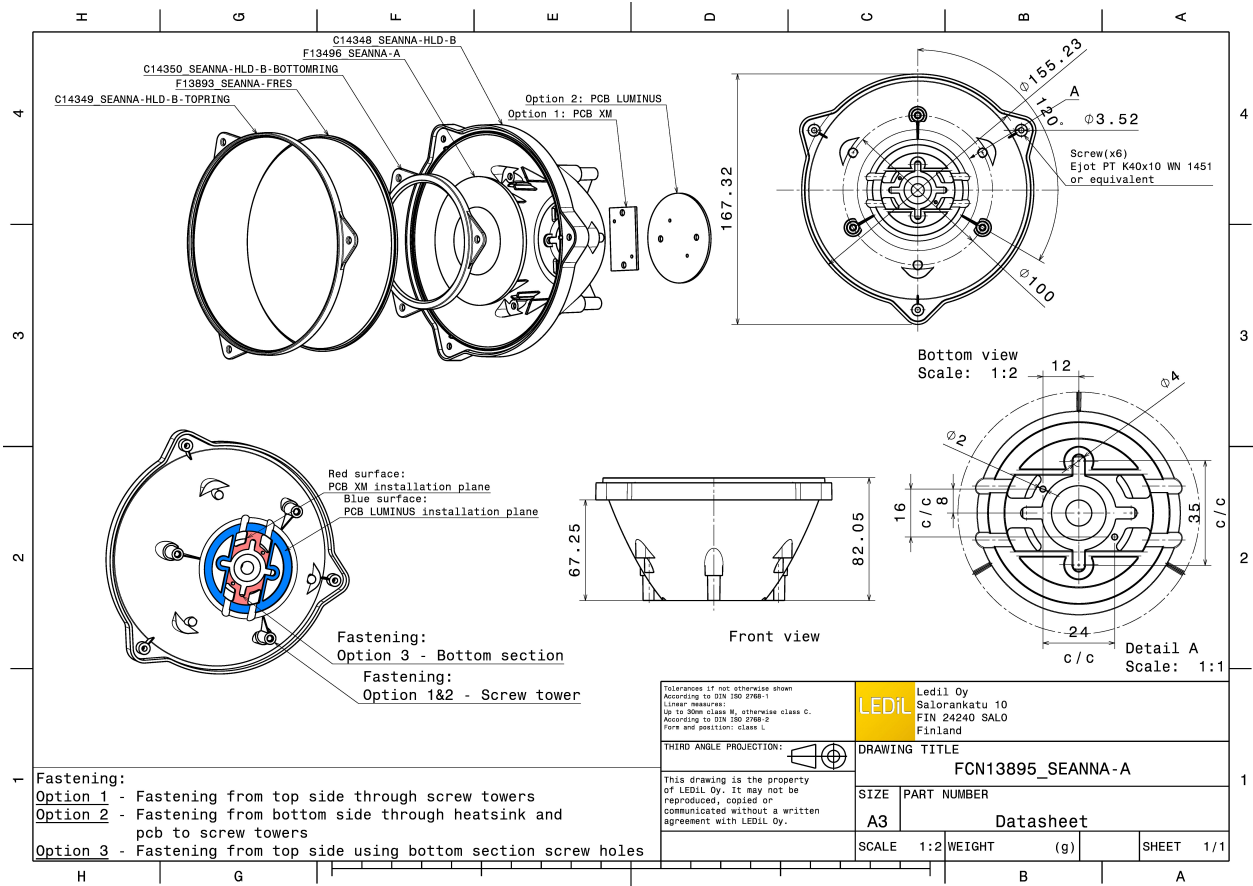

### ORDERING INFORMATION:

Component	Qty in box	MOQ	MPQ	Box weight (kg)
FCP13895_SEANNA-A » Box size:		20	2	6.5

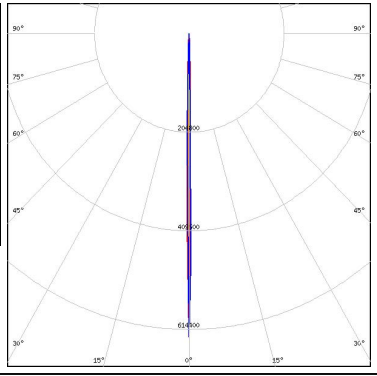

See also our general installation guide: [www.ledil.com/installation\\_guide](http://www.ledil.com/installation_guide)

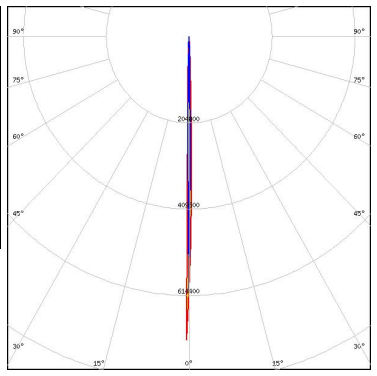
#### PHOTOMETRIC DATA (MEASURED):

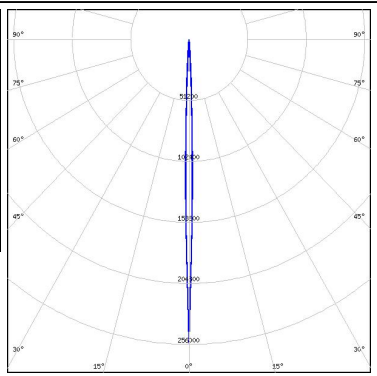
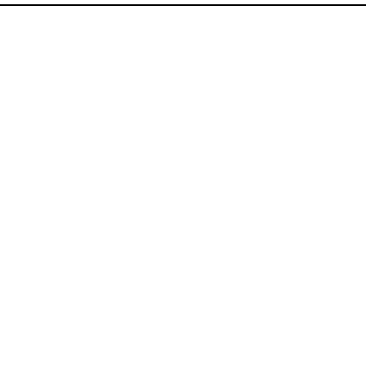
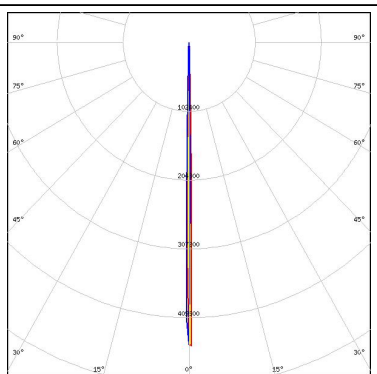
<p><b>CREE</b> ⇄ <b>LED</b></p> <p>LED           XD16            FWHM / FWTM   1.0° / 3.0°            Efficiency       91 %            Peak intensity   629 cd/lm            LEDs/each optic   1            Light colour     White            Required components:</p>		
<p><b>CREE</b> ⇄ <b>LED</b></p> <p>LED           XP-E2            FWHM / FWTM   1.0° / 3.0°            Efficiency       %            Peak intensity   718 cd/lm            LEDs/each optic   1            Light colour     White            Required components:</p>		
<p><b>CREE</b> ⇄ <b>LED</b></p> <p>LED           XP-L HD            FWHM / FWTM   2.4° / 5.3°            Efficiency       94 %            Peak intensity   255 cd/lm            LEDs/each optic   1            Light colour     White            Required components:</p>		
<p><b>CREE</b> ⇄ <b>LED</b></p> <p>LED           XP-L HI            FWHM / FWTM   1.6° / 3.2°            Efficiency       94 %            Peak intensity   492 cd/lm            LEDs/each optic   1            Light colour     White            Required components:</p>		

#### PHOTOMETRIC DATA (MEASURED):

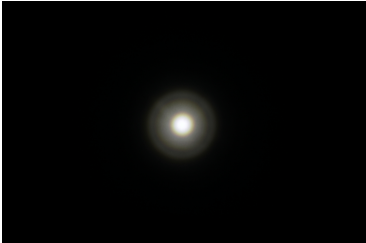
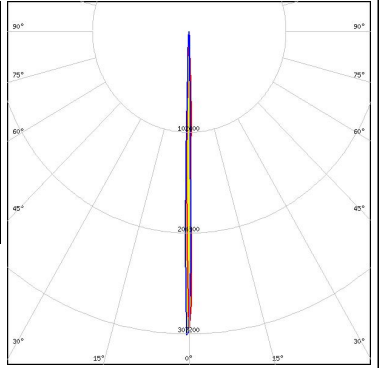
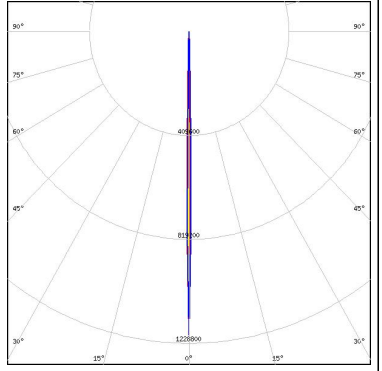
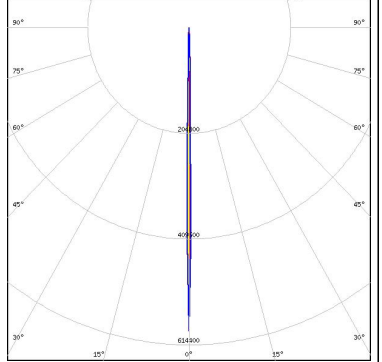
<p><b>NICHIA</b></p> <p>LED NVSW3x9A            FWHM / FWTM 1.9° / 4.1°            Efficiency 92 %            Peak intensity 310 cd/lm            LEDs/each optic 1            Light colour White            Required components:</p>		
<p><b>OSRAM</b>  <small>Opto Semiconductors</small></p> <p>LED OSOLON Black Flat            FWHM / FWTM 1.2° / 2.3°            Efficiency 94 %            Peak intensity 1196 cd/lm            LEDs/each optic 1            Light colour White            Required components:</p>		
<p><b>OSRAM</b>  <small>Opto Semiconductors</small></p> <p>LED OSOLON Square CSSRM2/CSSRM3            FWHM / FWTM 1.5° / 3.3°            Efficiency 94 %            Peak intensity 587 cd/lm            LEDs/each optic 1            Light colour White            Required components:</p>		







#### PHOTOMETRIC DATA (SIMULATED):

<p><b>CREE</b> LED</p> <p>LED MK-R            FWHM / FWTM 4.0° / 10.4°            Efficiency 91 %            Peak intensity 82 cd/lm            LEDs/each optic 1            Light colour White            Required components:</p>	
<p><b>CREE</b> LED</p> <p>LED XB-D            FWHM / FWTM 1.3° / 3.2°            Efficiency 87 %            Peak intensity 698 cd/lm            LEDs/each optic 1            Light colour White            Required components:</p>	
<p><b>CREE</b> LED</p> <p>LED XHP35 HD            FWHM / FWTM 2.4° / 4.2°            Efficiency 89 %            Peak intensity 257 cd/lm            LEDs/each optic 1            Light colour White            Required components:</p>	
<p><b>CREE</b> LED</p> <p>LED XHP35 HI            FWHM / FWTM 1.6° / 3.6°            Efficiency 83 %            Peak intensity 496 cd/lm            LEDs/each optic 1            Light colour White            Required components:</p>	

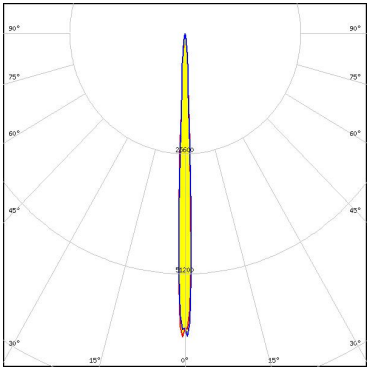
#### PHOTOMETRIC DATA (SIMULATED):

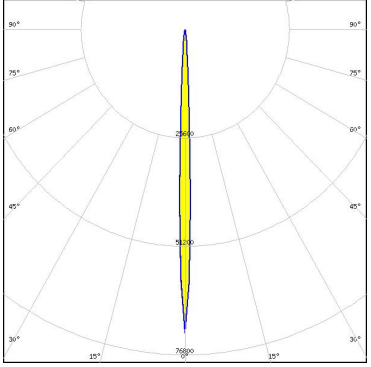
<p><b>CREE</b> LED</p> <p>LED: XHP35.2            FWHM / FWTM: 2.0° / 6.0°            Efficiency: 89 %            Peak intensity: 161.9 cd/lm            LEDs/each optic: 1            Light colour: White            Required components:</p>	
<p><b>CREE</b> LED</p> <p>LED: XHP35.2 HI            FWHM / FWTM: 2.0° / 4.0°            Efficiency: 89 %            Peak intensity: 161 cd/lm            LEDs/each optic: 1            Light colour: White            Required components:</p>	
<p><b>CREE</b> LED</p> <p>LED: XHP50            FWHM / FWTM: 3.3° / 6.7°            Efficiency: 87 %            Peak intensity: 122 cd/lm            LEDs/each optic: 1            Light colour: White            Required components:</p>	
<p><b>CREE</b> LED</p> <p>LED: XHP50.2            FWHM / FWTM: 2.7° / 6.8°            Efficiency: 84 %            Peak intensity: 128.7 cd/lm            LEDs/each optic: 1            Light colour: White            Required components:</p>	

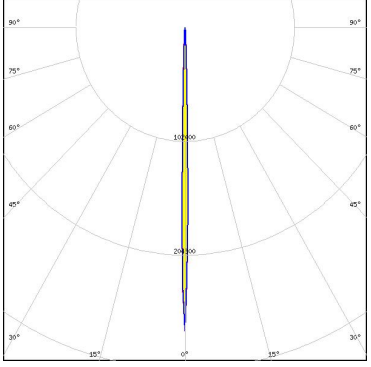
#### PHOTOMETRIC DATA (SIMULATED):

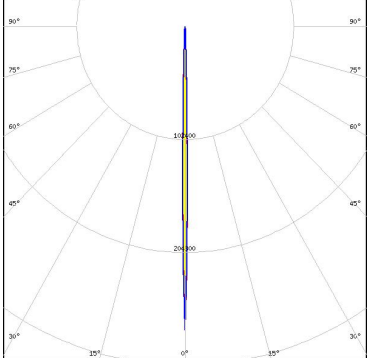





	<p>LED XHP70            FWHM / FWTM 4.3° / 10.4°            Efficiency 81 %            Peak intensity 69.9 cd/lm            LEDs/each optic 1            Light colour White            Required components:</p>	
	<p>LED XHP70.2            FWHM / FWTM 4.5° / 10.1°            Efficiency 83 %            Peak intensity 71.6 cd/lm            LEDs/each optic 1            Light colour White            Required components:</p>	
	<p>LED XM-L            FWHM / FWTM 2.4°            Efficiency %            Peak intensity 272 cd/lm            LEDs/each optic 1            Light colour White            Required components:</p>	
	<p>LED XM-L2            FWHM / FWTM 2.0° / 3.9°            Efficiency 85 %            Peak intensity 275 cd/lm            LEDs/each optic 1            Light colour White            Required components:</p>	

#### PHOTOMETRIC DATA (SIMULATED):

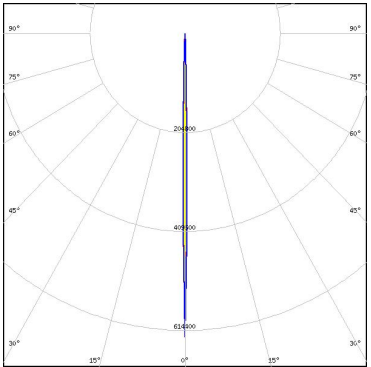
<p><b>CREE LED</b></p> <p>LED XM-L3            FWHM / FWTM 2.0° / 6.0°            Efficiency 90 %            Peak intensity 196.2 cd/lm            LEDs/each optic 1            Light colour White            Required components:</p>	
<p><b>CREE LED</b></p> <p>LED XP-E            FWHM / FWTM 1.2° / 2.9°            Efficiency 92 %            Peak intensity 955 cd/lm            LEDs/each optic 1            Light colour White            Required components:</p>	
<p><b>CREE LED</b></p> <p>LED XP-E2            FWHM / FWTM 2.0° / 6.0°            Efficiency 85 %            Peak intensity 211.5 cd/lm            LEDs/each optic 1            Light colour Blue            Required components:</p>	
<p><b>CREE LED</b></p> <p>LED XP-G            FWHM / FWTM 1.4° / 3.4°            Efficiency 90 %            Peak intensity 578 cd/lm            LEDs/each optic 1            Light colour White            Required components:</p>	

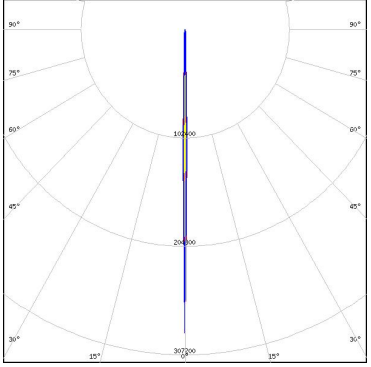

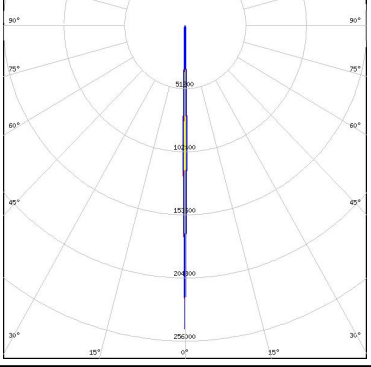
#### PHOTOMETRIC DATA (SIMULATED):

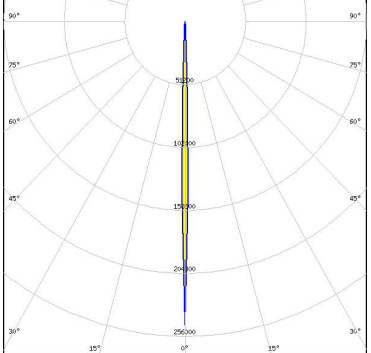
	<p>LED: XP-G2            FWHM / FWTM: 1.4° / 3.2°            Efficiency: 91 %            Peak intensity: 628 cd/lm            LEDs/each optic: 1            Light colour: White            Required components:</p>	
	<p>LED: XP-G2 HE            FWHM / FWTM: 2.0° / 4.0°            Efficiency: 89 %            Peak intensity: 286.5 cd/lm            LEDs/each optic: 1            Light colour: White            Required components:</p>	
	<p>LED: XP-G3            FWHM / FWTM: 2.0° / 4.0°            Efficiency: 88 %            Peak intensity: 246.2 cd/lm            LEDs/each optic: 1            Light colour: White            Required components:</p>	
	<p>LED: XP-P            FWHM / FWTM: 2.0° / 6.0°            Efficiency: 84 %            Peak intensity: 246.8 cd/lm            LEDs/each optic: 1            Light colour: White            Required components:</p>	

#### PHOTOMETRIC DATA (SIMULATED):



LED XQ-E HD  
 FWHM / FWTM 1.1° / 2.5°  
 Efficiency 92 %  
 Peak intensity 1460 cd/lm  
 LEDs/each optic 1  
 Light colour White  
 Required components:

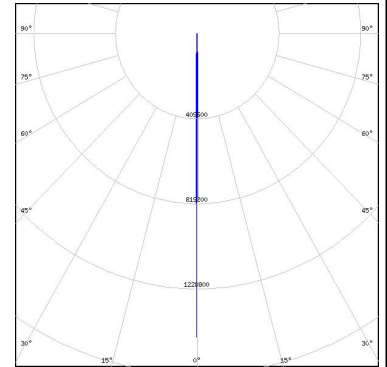

LED XQ-E HI  
 FWHM / FWTM 1.2° / 2.0°  
 Efficiency 90 %  
 Peak intensity 1300 cd/lm  
 LEDs/each optic 1  
 Light colour White  
 Required components:



LED XT-E  
 FWHM / FWTM 1.4° / 3.5°  
 Efficiency 88 %  
 Peak intensity 519 cd/lm  
 LEDs/each optic 1  
 Light colour White  
 Required components:

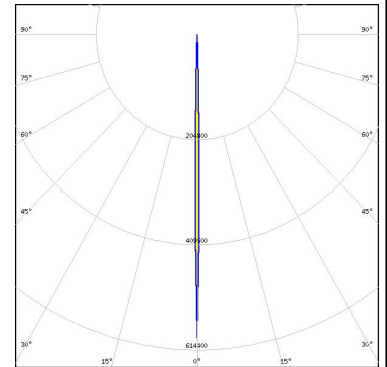

LED LZ4 (00xW00)  
 FWHM / FWTM 3.3° / 8.2°  
 Efficiency 91 %  
 Peak intensity 136 cd/lm  
 LEDs/each optic 1  
 Light colour White  
 Required components:

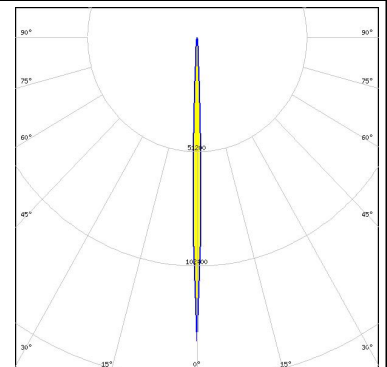

#### PHOTOMETRIC DATA (SIMULATED):

<p><b>LUMILEDS</b></p> <p>LED: LUXEON CZ            FWHM / FWTM: 1.4° / 3.7°            Efficiency: 94 %            Peak intensity: 424 cd/lm            LEDs/each optic: 1            Light colour: Green            Required components:</p>	
<p><b>LUMILEDS</b></p> <p>LED: LUXEON CZ            FWHM / FWTM: 1.3° / 3.4°            Efficiency: 94 %            Peak intensity: 564 cd/lm            LEDs/each optic: 1            Light colour: PC Amber            Required components:</p>	
<p><b>LUMILEDS</b></p> <p>LED: LUXEON CZ            FWHM / FWTM: 1.6° / 3.8°            Efficiency: 93 %            Peak intensity: 371 cd/lm            LEDs/each optic: 1            Light colour: Blue            Required components:</p>	
<p><b>LUMILEDS</b></p> <p>LED: LUXEON CZ            FWHM / FWTM: 1.2° / 3.3°            Efficiency: 94 %            Peak intensity: 564 cd/lm            LEDs/each optic: 1            Light colour: Red            Required components:</p>	

#### PHOTOMETRIC DATA (SIMULATED):

<p><b>LUMILEDS</b></p> <p>LED: LUXEON CZ</p> <p>FWHM / FWTM: 1.7° / 3.9°</p> <p>Efficiency: 93 %</p> <p>Peak intensity: 346 cd/lm</p> <p>LEDs/each optic: 1</p> <p>Light colour: White</p> <p>Required components:</p>	
<p><b>LUMILEDS</b></p> <p>LED: LUXEON HL2X</p> <p>FWHM / FWTM: 2.0° / 4.0°</p> <p>Efficiency: 89 %</p> <p>Peak intensity: 317.8 cd/lm</p> <p>LEDs/each optic: 1</p> <p>Light colour: White</p> <p>Required components:</p>	
<p><b>LUMILEDS</b></p> <p>LED: LUXEON M/MX</p> <p>FWHM / FWTM: 3.6° / 9.0°</p> <p>Efficiency: 89 %</p> <p>Peak intensity: 99 cd/lm</p> <p>LEDs/each optic: 1</p> <p>Light colour: White</p> <p>Required components:</p>	
<p><b>LUMILEDS</b></p> <p>LED: LUXEON MZ</p> <p>FWHM / FWTM: 2.2° / 6.0°</p> <p>Efficiency: 84 %</p> <p>Peak intensity: 151 cd/lm</p> <p>LEDs/each optic: 1</p> <p>Light colour: White</p> <p>Required components:</p>	

#### PHOTOMETRIC DATA (SIMULATED):

<p><b>LUMILEDS</b></p> <p>LED: LUXEON Rebel</p> <p>FWHM / FWTM: 1.3° / 3.2°</p> <p>Efficiency: 90 %</p> <p>Peak intensity: 704 cd/lm</p> <p>LEDs/each optic: 1</p> <p>Light colour: White</p> <p>Required components:</p>	
<p><b>LUMILEDS</b></p> <p>LED: LUXEON Rebel ES</p> <p>FWHM / FWTM: 1.6° / 3.6°</p> <p>Efficiency: 90 %</p> <p>Peak intensity: 530 cd/lm</p> <p>LEDs/each optic: 1</p> <p>Light colour: White</p> <p>Required components:</p>	
<p><b>LUMILEDS</b></p> <p>LED: LUXEON Rubix (white)</p> <p>FWHM / FWTM: 2.0° / 4.0°</p> <p>Efficiency: 88 %</p> <p>Peak intensity: 290.2 cd/lm</p> <p>LEDs/each optic: 1</p> <p>Light colour: White</p> <p>Required components:</p>	
<p><b>LUMILEDS</b></p> <p>LED: LUXEON S1000</p> <p>FWHM / FWTM: 3.8° / 8.0°</p> <p>Efficiency: 88 %</p> <p>Peak intensity: 100 cd/lm</p> <p>LEDs/each optic: 1</p> <p>Light colour: White</p> <p>Required components:</p>	

#### PHOTOMETRIC DATA (SIMULATED):

<p><b>LUMILEDS</b></p> <p>LED: LUXEON V2            FWHM / FWTM: 2.0° / 4.0°            Efficiency: 88 %            Peak intensity: 250.1 cd/lm            LEDs/each optic: 1            Light colour: White            Required components:</p>	
<p><b>LUMINUS</b></p> <p>LED: SBT-90            FWHM / FWTM: 2.0° / 6.0°            Efficiency: 76 %            Peak intensity: 175.9 cd/lm            LEDs/each optic: 1            Light colour: White            Required components:</p>	
<p><b>LUMINUS</b></p> <p>LED: SBT-90            FWHM / FWTM: 2.3° / 4.8°            Efficiency: 90 %            Peak intensity: 253 cd/lm            LEDs/each optic: 1            Light colour: White            Required components:</p>	
<p><b>NICHIA</b></p> <p>LED: NV4WB35AM            FWHM / FWTM: 2.0° / 4.0°            Efficiency: 90 %            Peak intensity: 185.5 cd/lm            LEDs/each optic: 1            Light colour: White            Required components:</p>	

#### PHOTOMETRIC DATA (SIMULATED):

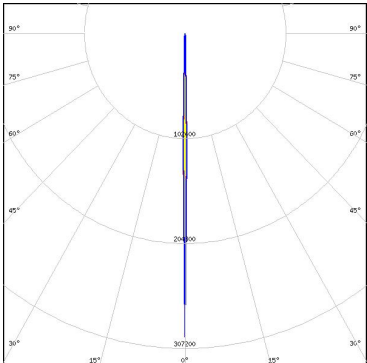
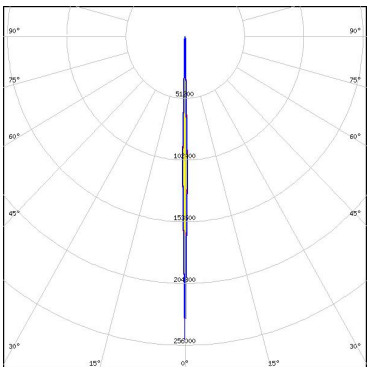
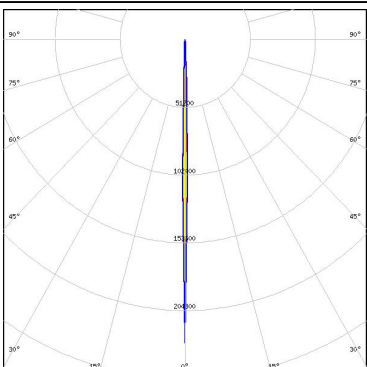
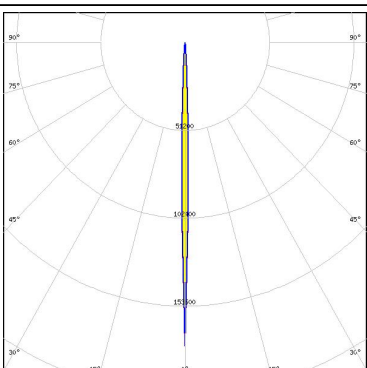
<p><b>NICHIA</b></p> <p>LED NVSW219F            FWHM / FWTM 2.0° / 4.0°            Efficiency 89 %            Peak intensity 296 cd/lm            LEDs/each optic 1            Light colour White            Required components:</p>	
<p><b>NICHIA</b></p> <p>LED NVSW519A            FWHM / FWTM 2.0° / 4.0°            Efficiency 89 %            Peak intensity 251.6 cd/lm            LEDs/each optic 1            Light colour White            Required components:</p>	
<p><b>OSRAM</b>  <small>Opto Semiconductors</small></p> <p>LED KW CSLPM1.TG            FWHM / FWTM 2.0° / 4.0°            Efficiency 90 %            Peak intensity 229.3 cd/lm            LEDs/each optic 1            Light colour White            Required components:</p>	
<p><b>OSRAM</b>  <small>Opto Semiconductors</small></p> <p>LED KW CULPM1.TG            FWHM / FWTM 2.0° / 6.0°            Efficiency 92 %            Peak intensity 176.8 cd/lm            LEDs/each optic 1            Light colour White            Required components:</p>	

#### PHOTOMETRIC DATA (SIMULATED):

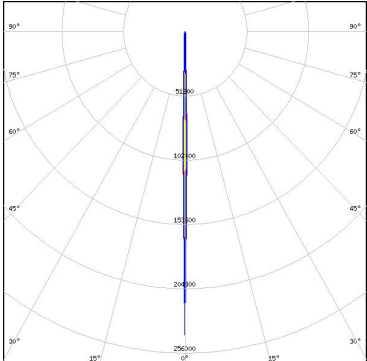
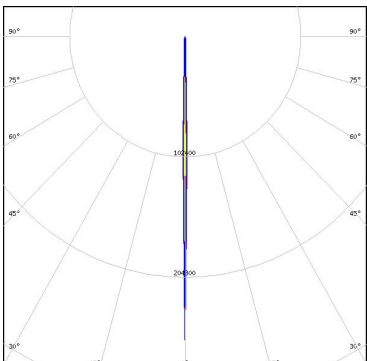
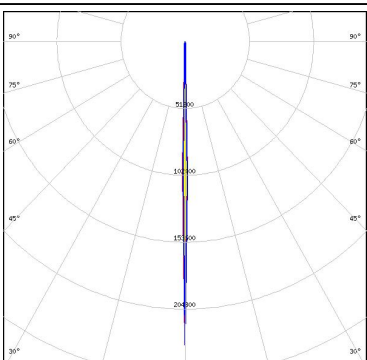
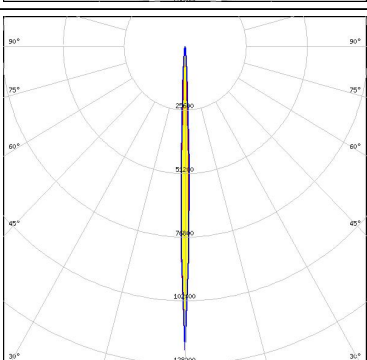
<p><b>OSRAM</b> Opto Semiconductors</p> <p>LED                      OSCONIQ C 2424</p> <p>FWHM / FWTM        2.0° / 4.0°</p> <p>Efficiency             90 %</p> <p>Peak intensity        241.6 cd/lm</p> <p>LEDs/each optic     1</p> <p>Light colour         White</p> <p>Required components:</p>	
<p><b>OSRAM</b> Opto Semiconductors</p> <p>LED                      OSCONIQ P 3737 (2W version)</p> <p>FWHM / FWTM        2.0° / 4.0°</p> <p>Efficiency             89 %</p> <p>Peak intensity        258.2 cd/lm</p> <p>LEDs/each optic     1</p> <p>Light colour         White</p> <p>Required components:</p>	
<p><b>OSRAM</b> Opto Semiconductors</p> <p>LED                      OSCONIQ P 3737 (3W version)</p> <p>FWHM / FWTM        2.0° / 4.0°</p> <p>Efficiency             90 %</p> <p>Peak intensity        232.3 cd/lm</p> <p>LEDs/each optic     1</p> <p>Light colour         White</p> <p>Required components:</p>	
<p><b>OSRAM</b> Opto Semiconductors</p> <p>LED                      OSCONIQ P 7070</p> <p>FWHM / FWTM        3.5° / 7.1°</p> <p>Efficiency             91 %</p> <p>Peak intensity        122.2 cd/lm</p> <p>LEDs/each optic     1</p> <p>Light colour         White</p> <p>Required components:</p>	



#### PHOTOMETRIC DATA (SIMULATED):

#### OSRAM

Opto Semiconductors

LED OSLON Square PC  
 FWHM / FWTM 1.5° / 3.6°  
 Efficiency 89 %  
 Peak intensity 550 cd/lm  
 LEDs/each optic 1  
 Light colour White  
 Required components:

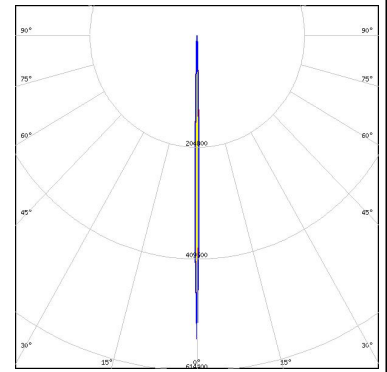

#### SAMSUNG

LED LH351B  
 FWHM / FWTM 2.0° / 4.0°  
 Efficiency 90 %  
 Peak intensity 279.4 cd/lm  
 LEDs/each optic 1  
 Light colour White  
 Required components:

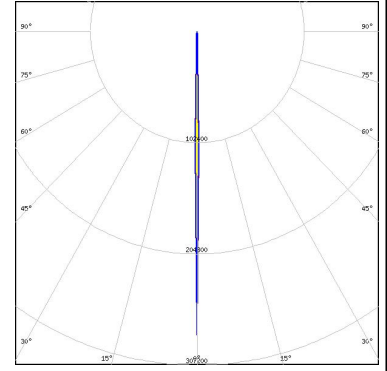

#### SAMSUNG

LED LH351C  
 FWHM / FWTM 2.0° / 4.0°  
 Efficiency 91 %  
 Peak intensity 279.2 cd/lm  
 LEDs/each optic 1  
 Light colour White  
 Required components:

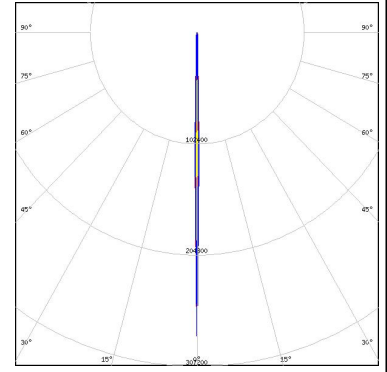

#### SAMSUNG

LED LH351D  
 FWHM / FWTM 2.0° / 4.0°  
 Efficiency 91 %  
 Peak intensity 235.3 cd/lm  
 LEDs/each optic 1  
 Light colour White  
 Required components:

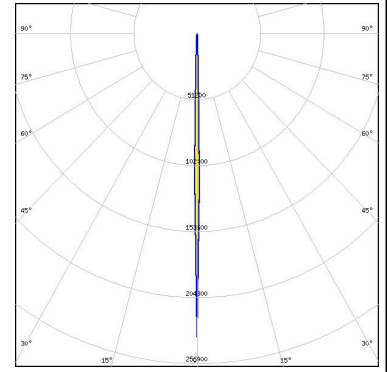

#### PHOTOMETRIC DATA (SIMULATED):



### GENERAL INFORMATION:

NOTE: The typical beam angle will be changed by different color, chip size and chip position tolerance. The typical total beam angle is the full angle measured where the luminous intensity is half of the peak value.

### MATERIALS:

As part of our continuous research and improvement processes, and to ensure the best possible quality and availability of our products, LEDiL reserves the right to change material grades without notice.

### PRODUCT DATA USER AGREEMENT AND DISCLAIMER:

The measured data in the provided downloadable LEDiL Product Datasheets and Mechanical 2D-Drawings is rounded and provided as reference for planning. LEDiL Oy's optical specifications have been verified by conducting performance testing of the products in accordance with the company's quality system. The reported data are averaged results of multiple measurements with typical variation. LEDiL Oy reserves the right to without prior notification make changes and improvements to its products.

LEDiL Oy assumes neither warranty, nor guarantee nor any other liability of any kind for the contents and correctness of the provided data. The provided data has been generated with highest diligence but the provided data may in reality not represent the complete possible variation range of all intrinsic parameters. Therefore, in certain cases a deviation from the provided data could occur.

LEDiL Oy reserves the right to undertake technical changes of its products without further notification which could lead to changes in the provided data. LEDiL Oy assumes no liability of any kind for the possible deviation from any provided data or any other damage resulting from the usage of the provided data.

The user agrees to this disclaimer and user agreement with the download or usage of the provided files.

#### LEDiL Oy

Joensuunkatu 13  
FI-24240 SALO  
Finland

#### LEDiL Inc.

228 West Page Street  
Suite D  
Sycamore IL 60178  
USA

#### Ledil Optics Technology (Shenzhen) Co., Ltd.

# 405 , Block B  
Casic Motor Building  
Shenzhen 518057  
P.R.CHINA

#### Local sales and technical support

[www.ledil.com/  
where\\_to\\_buy](http://www.ledil.com/where_to_buy)

#### Shipping locations

Salo, Finland  
Hong Kong, China

#### Distribution Partners

[www.ledil.com/  
where\\_to\\_buy](http://www.ledil.com/where_to_buy)

## X-ON Electronics

Largest Supplier of Electrical and Electronic Components

*Click to view similar products for [LED Lighting Lenses Assemblies](#) category:*

*Click to view products by [Ledil](#) manufacturer:*

Other Similar products are found below :

[FCN12592\\_LE1-D-COP](#) [CA16129\\_OLGA-W](#) [CA16370\\_HB-SQ-W](#) [FN15972\\_RONDA-ZT45-C](#) [CS15759\\_HB-2X2MX-8-W](#)  
[CA16435\\_LXP2-SS-WAS](#) [CN16210\\_GABRIELLA-MIDI-W](#) [CP17137\\_CARMEN-M2-C](#) [CA16015\\_STRADA-SQ-SCL](#) [CP17594\\_TINA-SC-](#)  
[RS](#) [CS15767\\_HB-2X2MX-8-M](#) [CP10960\\_RGBX-SS](#) [CP12395\\_LXP3-W](#) [CP12939\\_LARISA-RS-CLIP16](#) [C14636\\_XTM-PF-ADAPTER](#)  
[CA11819\\_STRADA-SQ-T-DW](#) [CA14508\\_G2-LXP2-D](#) [CA14601\\_VERONICA-SQ-MINI-RS](#) [FCP13895\\_SEANNA-A](#) [CP12943\\_LARISA-](#)  
[O-CLIP16](#) [FP11124\\_LISA2-O-PIN](#) [CS14597\\_HB-IP-2X6-O](#) [CP14995\\_FLORENTINA-HLD-O](#) [CS15158\\_STRADA-IP-2X6-T4-B](#)  
[CS16323\\_STRADELLA-IP-28-HB-M](#) [FN14976\\_STELLA-DWC2](#) [FN15264\\_STELLA-HB-WWW](#) [CA15584\\_ZORYA-MINI-TAPE](#)  
[FA15229\\_ROSE-MRK-S](#) [FA15232\\_ROSE-MRK-M](#) [FA15233\\_ROSE-MRK-W](#) [FCN13552\\_CRYSTAL-RS](#) [FN15552\\_RONDA-W](#)  
[FS15626\\_FLORENCE-3R-IP-Z90](#) [FS15786\\_FLORENCE-3R-IP-Z60](#) [FS15847\\_FLORENCE-3R-IP-O](#) [CA14505\\_G2-LXP2-RS2-P](#)  
[FCN12775\\_IRIS-O](#) [CP15304\\_LARISA-RS-PIN](#) [FN15679\\_RONDA-S](#) [CA15519\\_VERONICA-SQ-MINI-D](#) [FP14414\\_LISA2-O-PIN](#)  
[LL01CR-DF60L06-M2](#) [FN15993\\_RONDA-O](#) [FN15977\\_RONDA-WAS2](#) [CA14366\\_FLARE-MAXI-TAPE](#) [CA14442\\_VERONICA-SQ-W](#)  
[CA14509\\_G2-LXP2-M-P](#) [CA15231\\_VERONICA-SQ-MINI-W](#) [FP11002\\_LISA2-W-PIN](#)