

## OLIVIA-S

~20° spot beam

### TECHNICAL SPECIFICATIONS:

Dimensions	Ø 70.0 mm
Height	22.6 mm
Fastening	screw
ROHS compliant	yes ⓘ

### MATERIAL SPECIFICATIONS:

Component	Type	Material	Colour	Finish
OLIVIA-S	Single lens	PC		
OLIVIA-HLD	Holder	PC		

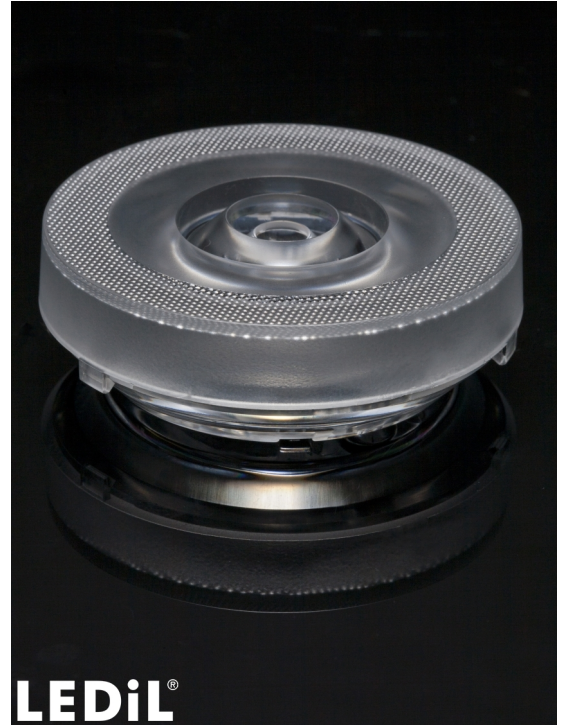

### ORDERING INFORMATION:



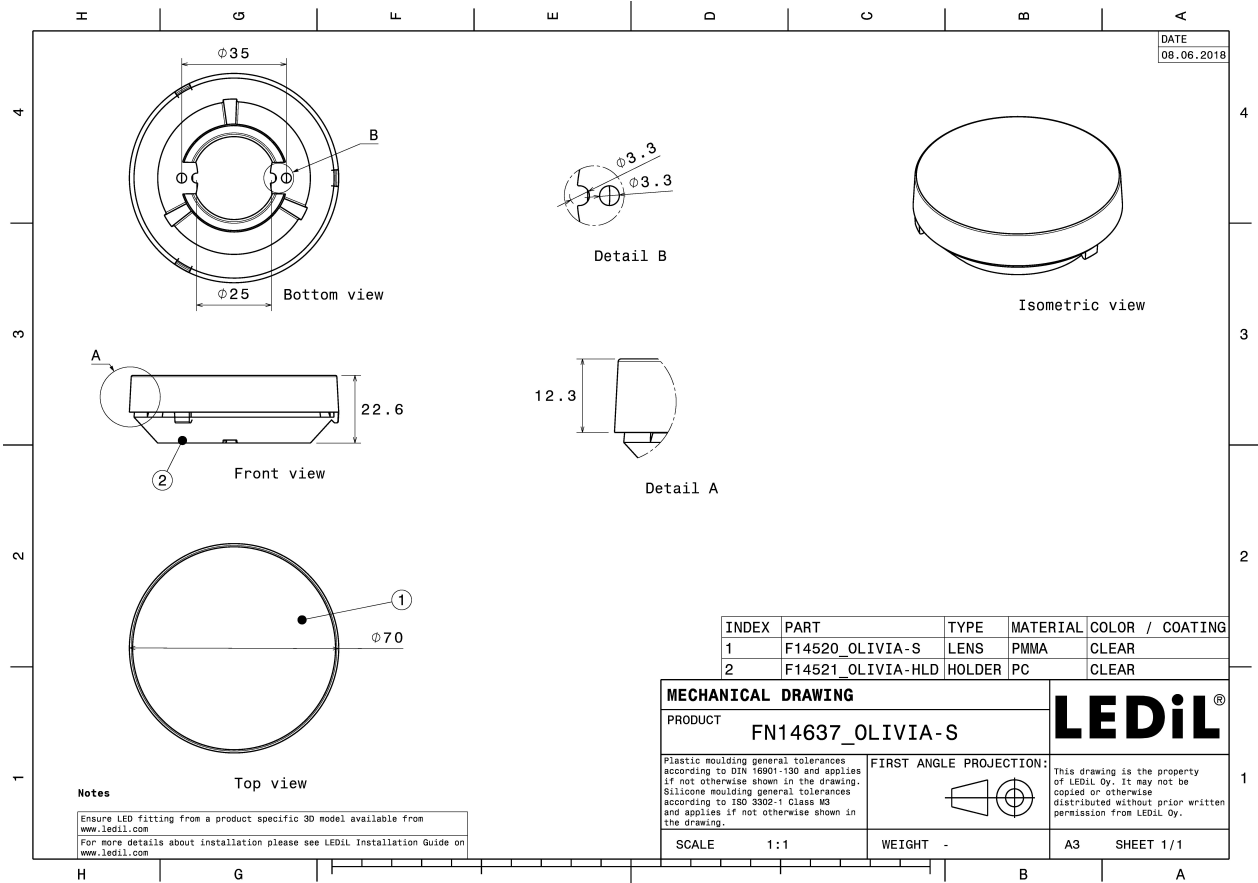

Component		Qty in box	MOQ	MPQ	Box weight (kg)
FN14637_OLIVIA-S	Single lens		140	20	0.0
» Box size:					

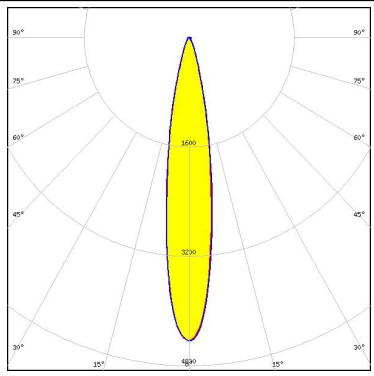
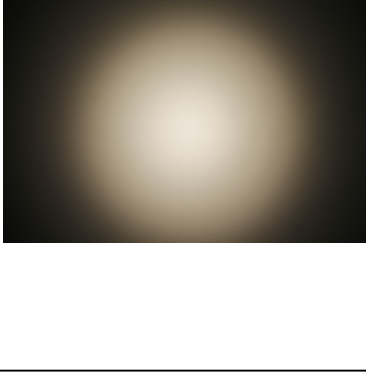
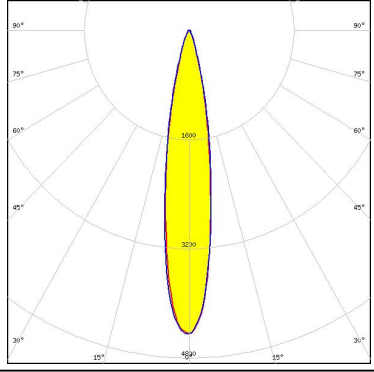
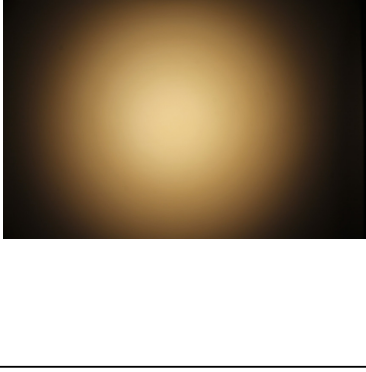
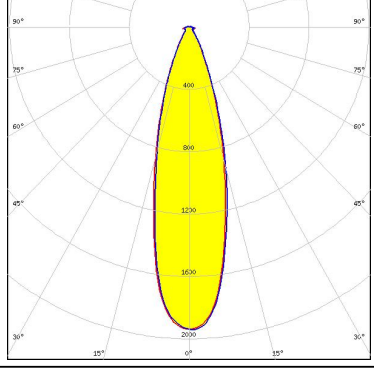
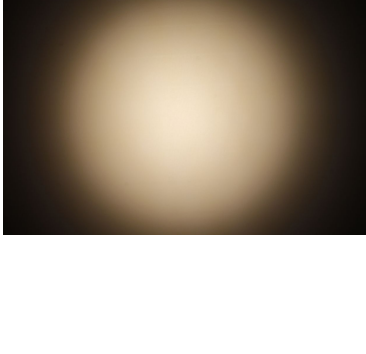
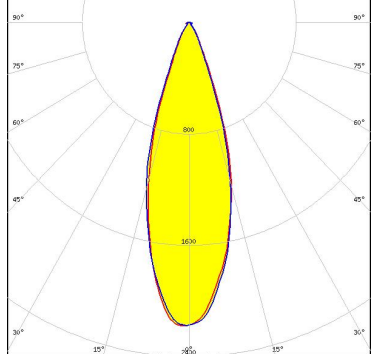

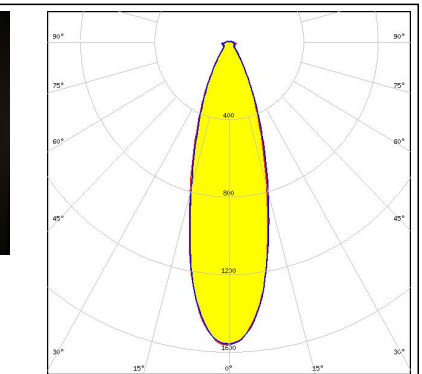
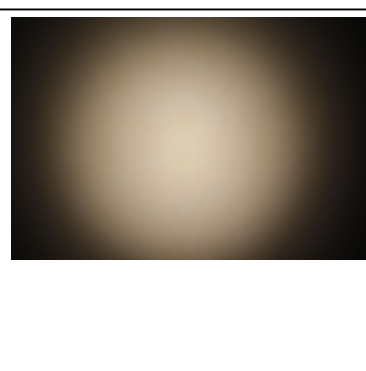
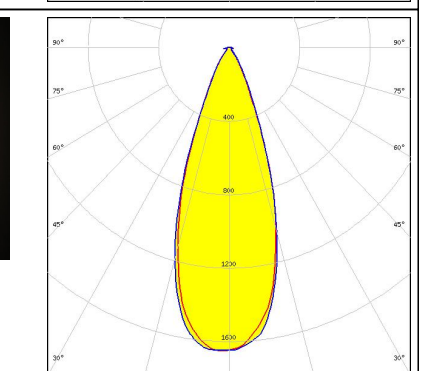

#### PHOTOMETRIC DATA (MEASURED):

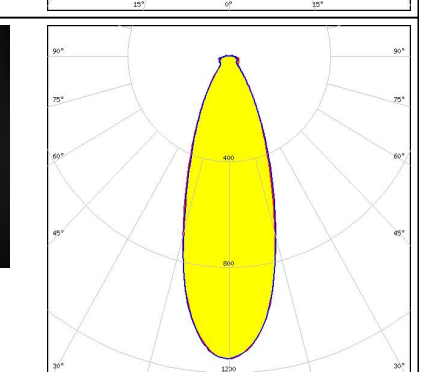
<p>bridgelux.</p> <p>LED V10 Gen6</p> <p>FWHM 18.0°</p> <p>Efficiency 75 %</p> <p>Peak intensity 4.400 cd/lm</p> <p>LEDs/each optic 1</p> <p>Light colour White</p> <p>Required components: BJB: 47.319.6214</p>		
<p>bridgelux.</p> <p>LED V10 Gen7</p> <p>FWHM 18.0°</p> <p>Efficiency 75 %</p> <p>Peak intensity 4.500 cd/lm</p> <p>LEDs/each optic 1</p> <p>Light colour White</p> <p>Required components: BJB: 47.319.6060</p>		
<p>bridgelux.</p> <p>LED V15 Gen6</p> <p>FWHM 28.0°</p> <p>Efficiency 74 %</p> <p>Peak intensity 1.900 cd/lm</p> <p>LEDs/each optic 1</p> <p>Light colour White</p> <p>Required components: BJB: 47.319.2224</p>		
<p>bridgelux.</p> <p>LED V15 Gen6</p> <p>FWHM 32.0°</p> <p>Efficiency 79 %</p> <p>Peak intensity 2.200 cd/lm</p> <p>LEDs/each optic 1</p> <p>Light colour White</p> <p>Required components:</p>		

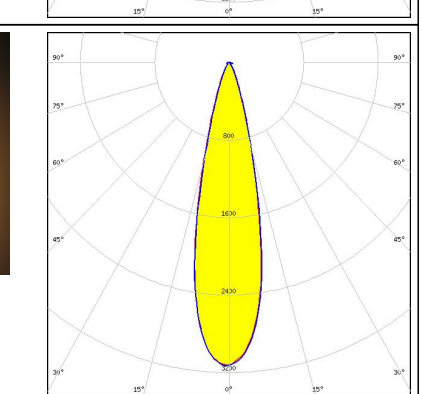
#### PHOTOMETRIC DATA (MEASURED):

<p>bridgelux.</p> <p>LED V18 Gen6            FWHM 31.0°            Efficiency 73 %            Peak intensity 1.600 cd/lm            LEDs/each optic 1            Light colour White            Required components:            BJB: 47.319.2274</p>		
<p>bridgelux.</p> <p>LED V18 Gen6            FWHM 37.0°            Efficiency 78 %            Peak intensity 1.700 cd/lm            LEDs/each optic 1            Light colour White            Required components:</p>		
<p>bridgelux.</p> <p>LED V22 Gen6            FWHM 35.0°            Efficiency 71 %            Peak intensity 1.100 cd/lm            LEDs/each optic 1            Light colour White            Required components:            A.A.G. STUCCHI: 8102/G2</p>		
<p>bridgelux.</p> <p>LED Vero SE 13            FWHM 24.0°            Efficiency 77 %            Peak intensity 3.100 cd/lm            LEDs/each optic 1            Light colour White            Required components:</p>		

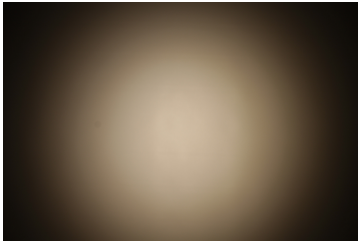
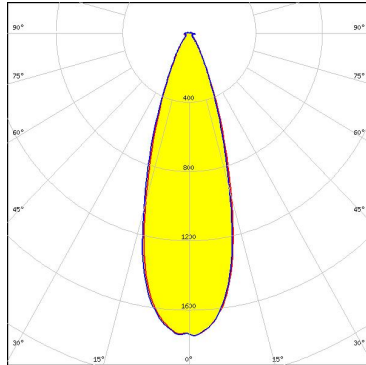
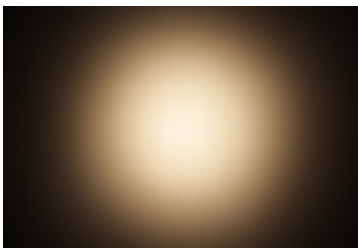
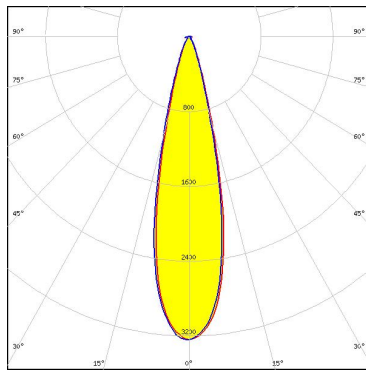
#### PHOTOMETRIC DATA (MEASURED):

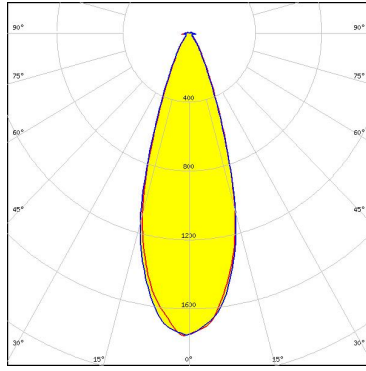
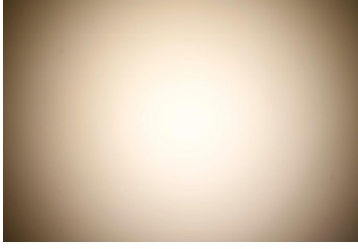
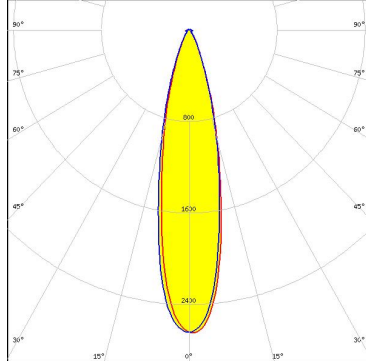
<p>bridgelux.</p> <p>LED           Vero SE 18</p> <p>FWHM        33.0°</p> <p>Efficiency    76 %</p> <p>Peak intensity 1.800 cd/lm</p> <p>LEDs/each optic 1</p> <p>Light colour   White</p> <p>Required components:</p>		
<p>bridgelux.</p> <p>LED           Xenio Point 13mm</p> <p>FWHM        25.0°</p> <p>Efficiency    80 %</p> <p>Peak intensity 3.240 cd/lm</p> <p>LEDs/each optic 1</p> <p>Light colour   White</p> <p>Required components:</p>		
<p>bridgelux.</p> <p>LED           Xenio Point 18mm</p> <p>FWHM        35.0°</p> <p>Efficiency    79 %</p> <p>Peak intensity 1.760 cd/lm</p> <p>LEDs/each optic 1</p> <p>Light colour   White</p> <p>Required components:</p>		
<p><b>CITIZEN</b></p> <p>LED           CLL03x/CLU03x</p> <p>FWHM        23.0°</p> <p>Efficiency    76 %</p> <p>Peak intensity 2.700 cd/lm</p> <p>LEDs/each optic 1</p> <p>Light colour   White</p> <p>Required components:</p> <p>    A.A.G. STUCCHI: 8101/G2</p>		

**PHOTOMETRIC DATA (MEASURED):**

**CITIZEN**

LED CLL03x/CLU03x  
FWHM 26.0°  
Efficiency 76 %  
Peak intensity 2.400 cd/lm  
LEDs/each optic 1  
Light colour White  
Required components:  
A.A.G. STUCCHI: 8101/G2

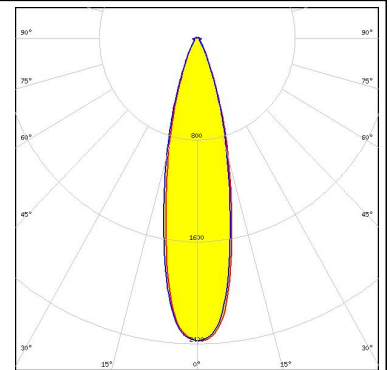
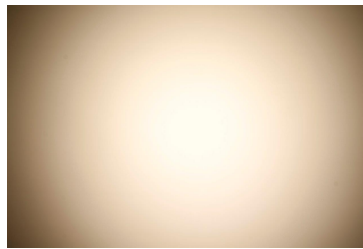

**CITIZEN**

LED CLU700/701/702  
FWHM 14.0°  
Efficiency 75 %  
Peak intensity 7.000 cd/lm  
LEDs/each optic 1  
Light colour White  
Required components:  
A.A.G. STUCCHI: 8100/G2

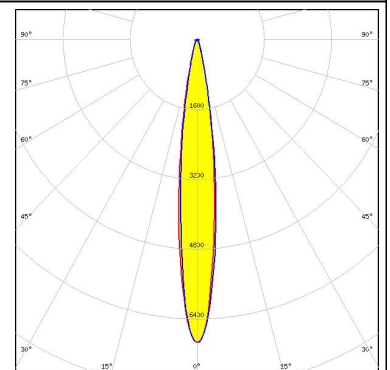
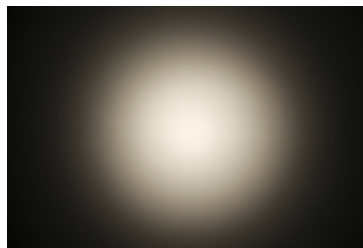

**CITIZEN**

LED CLU700/701/702  
FWHM 19.0°  
Efficiency 74 %  
Peak intensity 4.400 cd/lm  
LEDs/each optic 1  
Light colour White  
Required components:  
BJB: 47.319.6060

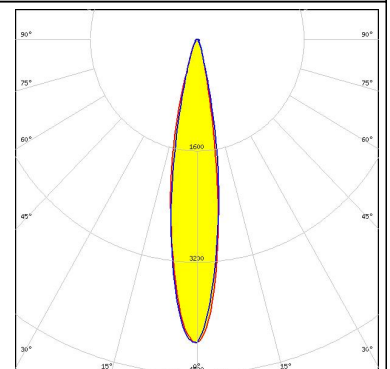
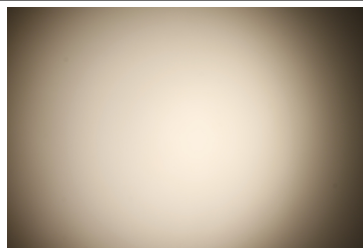

**CITIZEN**

LED CLU720/721  
FWHM 20.0°  
Efficiency 74 %  
Peak intensity 3.300 cd/lm  
LEDs/each optic 1  
Light colour White  
Required components:  
TE: 2213254-2

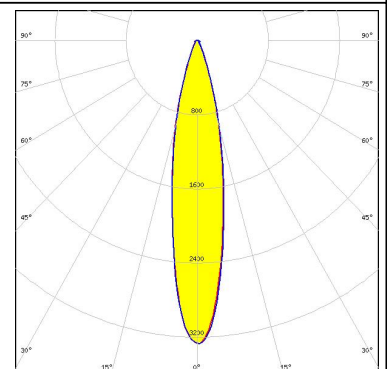
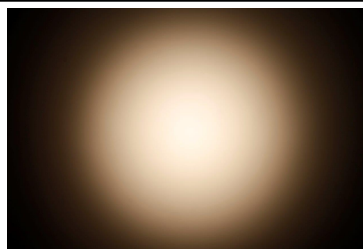

#### PHOTOMETRIC DATA (MEASURED):

#### CITIZEN

LED CLU720/721  
 FWHM 21.0°  
 Efficiency 74 %  
 Peak intensity 3.200 cd/lm  
 LEDs/each optic 1  
 Light colour White  
 Required components:  
 BJB: 47.319.2021

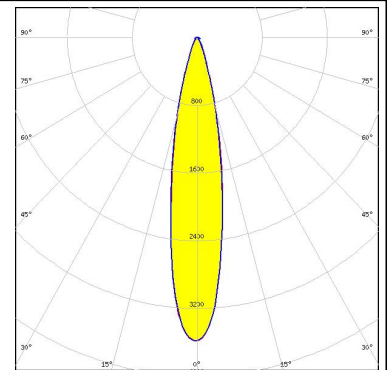
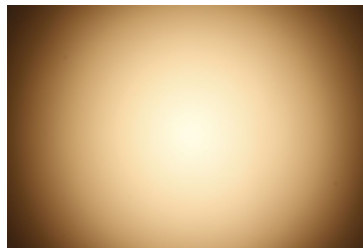

#### CITIZEN

LED CLU720/721  
 FWHM 20.0°  
 Efficiency 76 %  
 Peak intensity 3.600 cd/lm  
 LEDs/each optic 1  
 Light colour White  
 Required components:  
 A.A.G. STUCCHI: 8101/G2

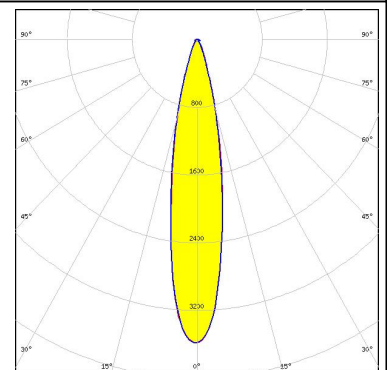
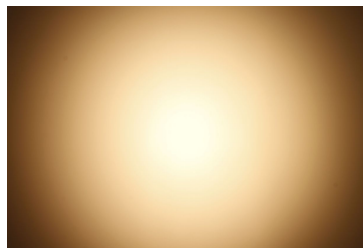

#### CREE

LED CXA/B 13xx  
 FWHM 14.0°  
 Efficiency 74 %  
 Peak intensity 7.000 cd/lm  
 LEDs/each optic 1  
 Light colour White  
 Required components:  
 BJB: 47.319.6120

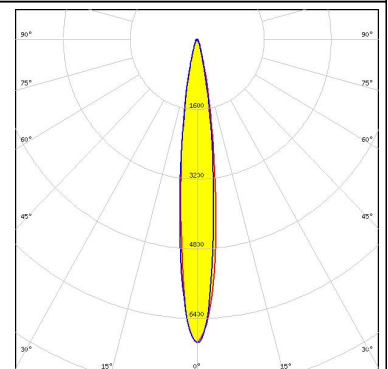
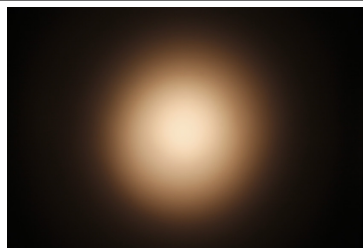

#### CREE

LED CXA/B 1816 & CXA/B 1820 & CXA 1850  
 FWHM 21.0°  
 Efficiency 76 %  
 Peak intensity 3.300 cd/lm  
 LEDs/each optic 1  
 Light colour White  
 Required components:  
 BJB: 47.319.2131

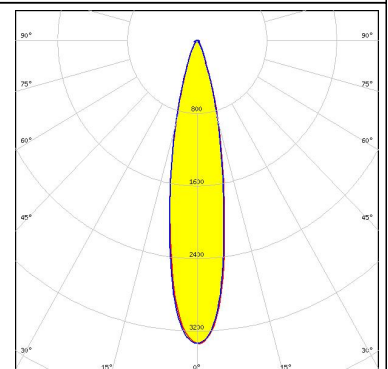
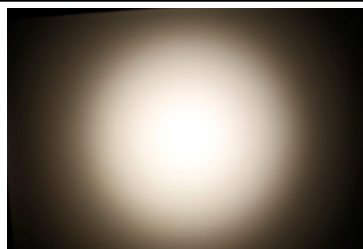

#### PHOTOMETRIC DATA (MEASURED):



LED CXA/B 25xx  
 FWHM 29.0°  
 Efficiency 74 %  
 Peak intensity 1.700 cd/lm  
 LEDs/each optic 1  
 Light colour White  
 Required components:  
 A.A.G. STUCCHI: 8401/G2

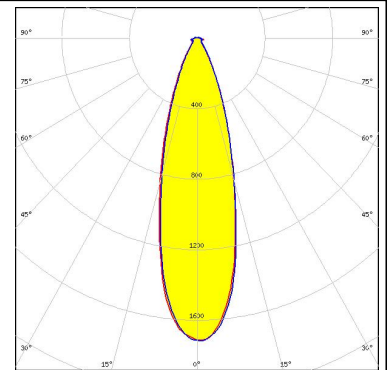
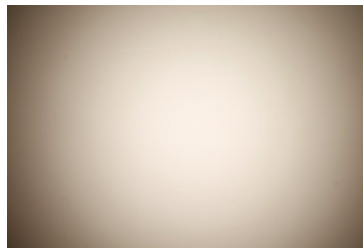

LED CXA/B 25xx  
 FWHM 29.0°  
 Efficiency 73 %  
 Peak intensity 1.600 cd/lm  
 LEDs/each optic 1  
 Light colour White  
 Required components:  
 TE: 2213407-2

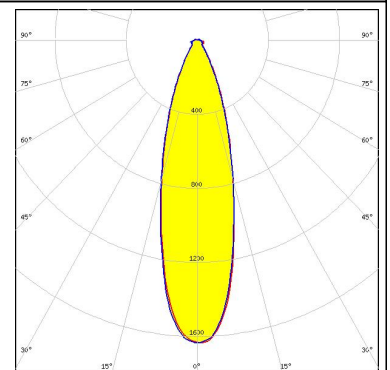
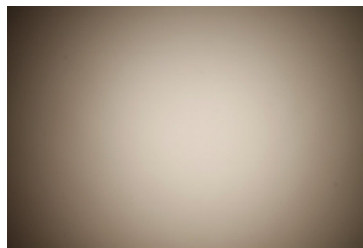

LED CXA/B 25xx  
 FWHM 29.0°  
 Efficiency 74 %  
 Peak intensity 1.700 cd/lm  
 LEDs/each optic 1  
 Light colour White  
 Required components:  
 BJB: 47.319.2040

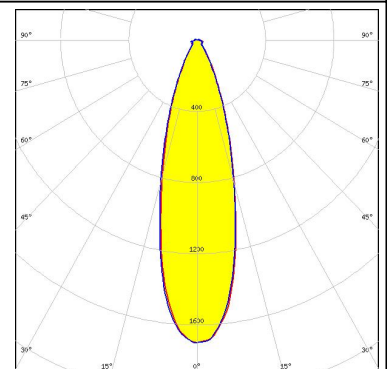
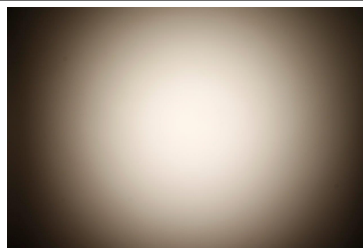

LED LUXEON CoB 1204/1205  
 FWHM 26.0°  
 Efficiency 77 %  
 Peak intensity 3.100 cd/lm  
 LEDs/each optic 1  
 Light colour White  
 Required components:  
 Bender Wirth: 432 Typ Z1

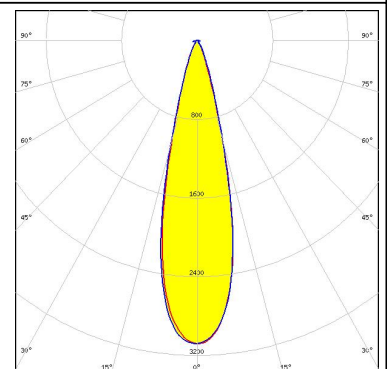
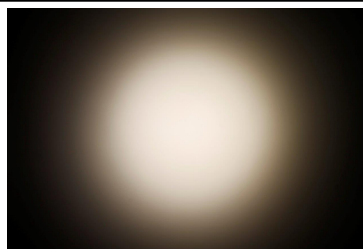



#### PHOTOMETRIC DATA (MEASURED):

##### LUMILEDS

LED LUXEON CoB 1204/1205  
 FWHM 23.0°  
 Efficiency 76 %  
 Peak intensity 2.800 cd/lm  
 LEDs/each optic 1  
 Light colour White  
 Required components:  
 A.A.G. STUCCHI: 8301/G2

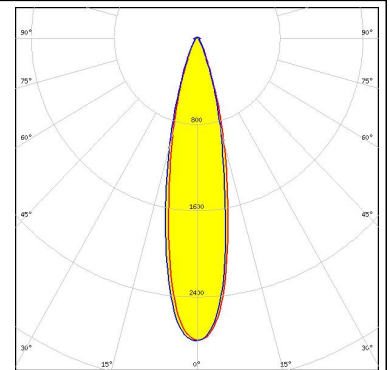
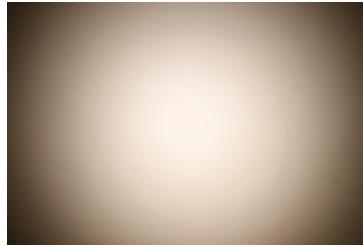

##### LUMILEDS

LED LUXEON CoB 1208  
 FWHM 27.0°  
 Efficiency 74 %  
 Peak intensity 2.100 cd/lm  
 LEDs/each optic 1  
 Light colour White  
 Required components:  
 A.A.G. STUCCHI: 8301/G2

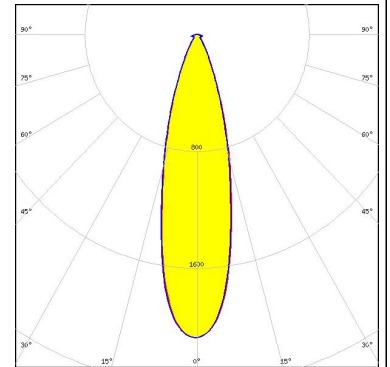
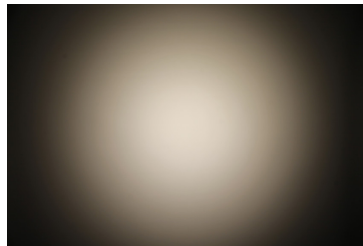

##### LUMILEDS

LED LUXEON CoB 1208  
 FWHM 29.0°  
 Efficiency 77 %  
 Peak intensity 2.400 cd/lm  
 LEDs/each optic 1  
 Light colour White  
 Required components:  
 Bender Wirth: 432 Typ Z1

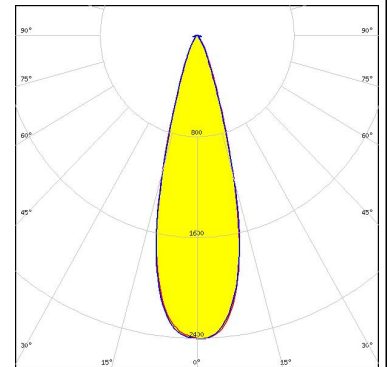
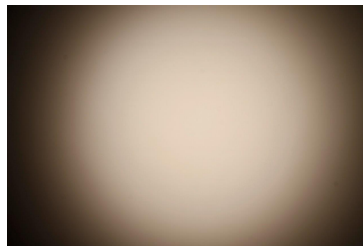

##### LUMILEDS

LED LUXEON CoB 1211  
 FWHM 32.0°  
 Efficiency 73 %  
 Peak intensity 1.480 cd/lm  
 LEDs/each optic 1  
 Light colour White  
 Required components:  
 BJB: 47.319.2030

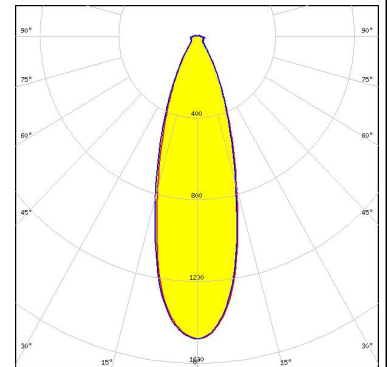
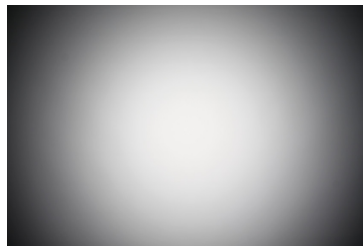

#### PHOTOMETRIC DATA (MEASURED):

#### LUMILEDS

LED LUXEON CoB 1216/1812  
 FWHM 37.0°  
 Efficiency 71 %  
 Peak intensity 1.080 cd/lm  
 LEDs/each optic 1  
 Light colour White  
 Required components:  
 BJB: 47.319.2030

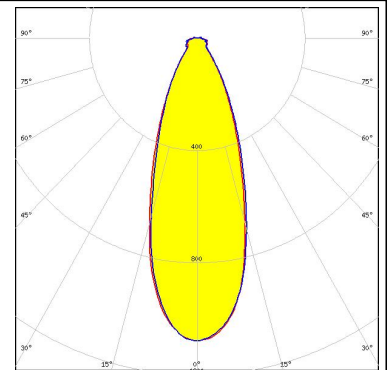
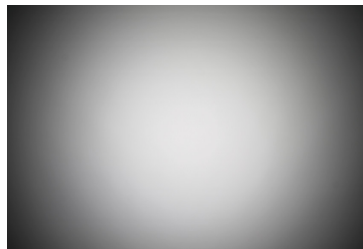

#### LUMILEDS

LED LUXEON CoB Compact  
 FWHM 15.0°  
 Efficiency 75 %  
 Peak intensity 6.100 cd/lm  
 LEDs/each optic 1  
 Light colour White  
 Required components:  
 BJB: 47.319.6180

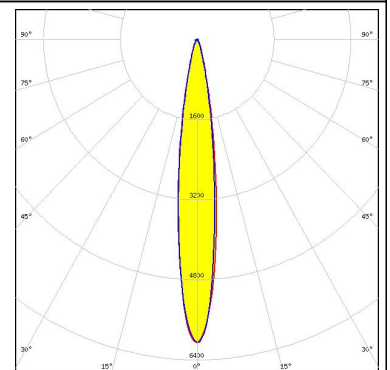
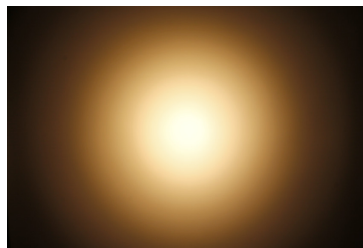

#### PHILIPS

LED Fortimo SLM L09 + SLM holder (PI)  
 FWHM 18.0°  
 Efficiency 78 %  
 Peak intensity 4.950 cd/lm  
 LEDs/each optic 1  
 Light colour White  
 Required components:

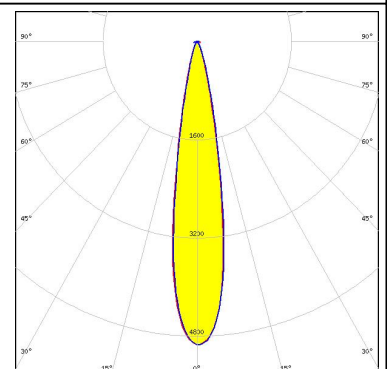
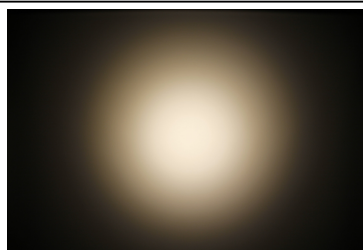

#### PHILIPS

LED Fortimo SLM L13 + SLM holder (PI)  
 FWHM 25.0°  
 Efficiency 76 %  
 Peak intensity 2.820 cd/lm  
 LEDs/each optic 1  
 Light colour White  
 Required components:

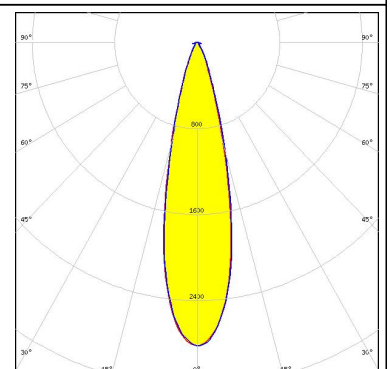
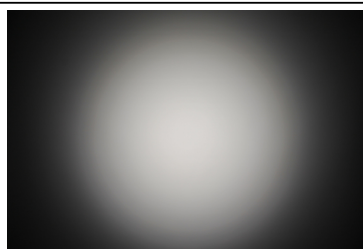

#### PHOTOMETRIC DATA (MEASURED):

#### PHILIPS

LED Fortimo SLM L15 + SLM holder (PI)  
 FWHM 28.0°  
 Efficiency 76 %  
 Peak intensity 2.230 cd/lm  
 LEDs/each optic 1  
 Light colour White  
 Required components:

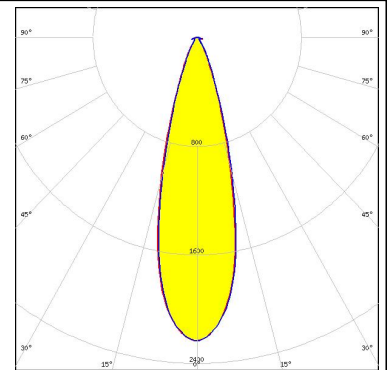

#### PHILIPS

LED Fortimo SLM L19 + SLM holder (PI)  
 FWHM 35.0°  
 Efficiency 75 %  
 Peak intensity 1.500 cd/lm  
 LEDs/each optic 1  
 Light colour White  
 Required components:

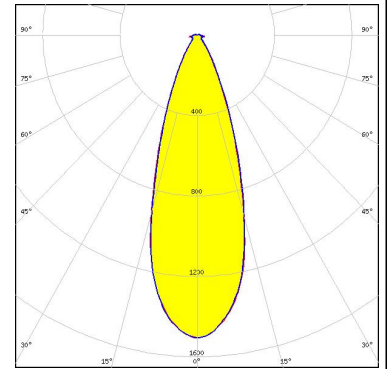
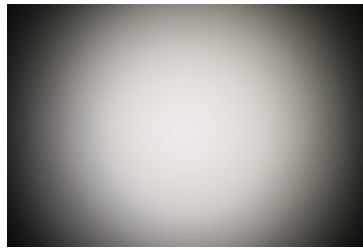

#### PHILIPS

LED Fortimo SLM L23 CoB  
 FWHM 39.0°  
 Efficiency 72 %  
 Peak intensity 1.100 cd/lm  
 LEDs/each optic 1  
 Light colour White  
 Required components:

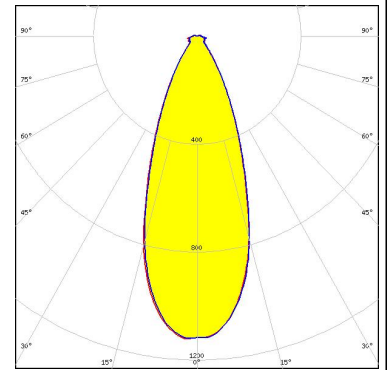
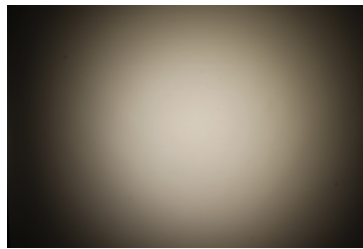

#### SAMSUNG

LED COB D Series LES 14.5 mm  
 FWHM 26.0°  
 Efficiency 76 %  
 Peak intensity 2.220 cd/lm  
 LEDs/each optic 1  
 Light colour White  
 Required components:  
 BJB: 47.319.2021

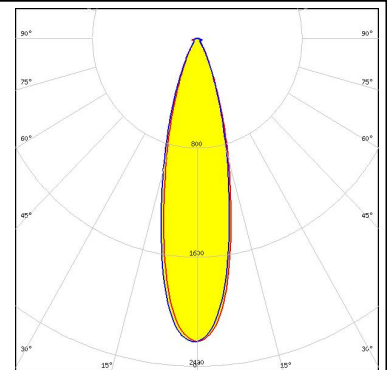
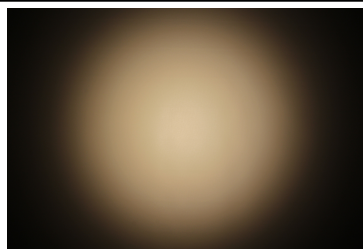

**PHOTOMETRIC DATA (MEASURED):**

**SAMSUNG**

LED COB D Series LES 14.5 mm  
 FWHM 26.0°  
 Efficiency 76 %  
 Peak intensity 2.220 cd/lm  
 LEDs/each optic 1  
 Light colour White  
 Required components:  
 A.A.G. STUCCHI: 8101/G2

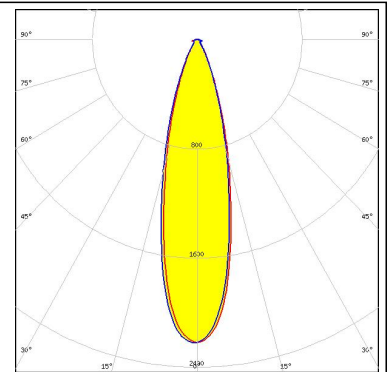

**SAMSUNG**

LED COB D Series LES 9.8 mm  
 FWHM 18.0°  
 Efficiency 77 %  
 Peak intensity 4.400 cd/lm  
 LEDs/each optic 1  
 Light colour White  
 Required components:  
 A.A.G. STUCCHI: 8100/G2

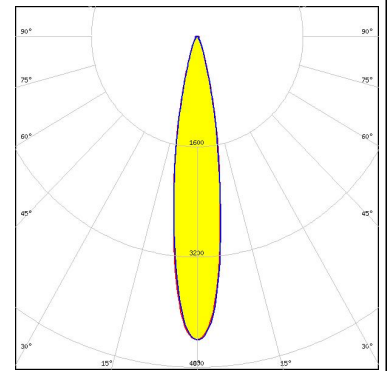
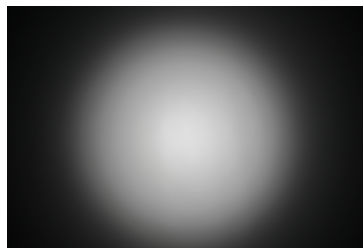

**SAMSUNG**

LED COB D Series LES 9.8 mm  
 FWHM 18.0°  
 Efficiency 77 %  
 Peak intensity 4.400 cd/lm  
 LEDs/each optic 1  
 Light colour White  
 Required components:  
 BJB: 47.319.6060

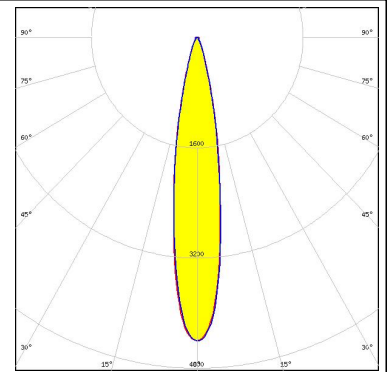
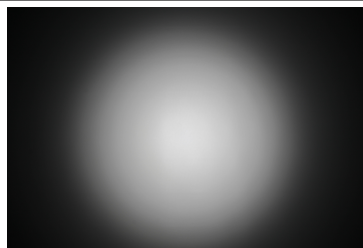

**SAMSUNG**

LED SLE-013  
 FWHM 21.0°  
 Efficiency 75 %  
 Peak intensity 3.100 cd/lm  
 LEDs/each optic 1  
 Light colour White  
 Required components:

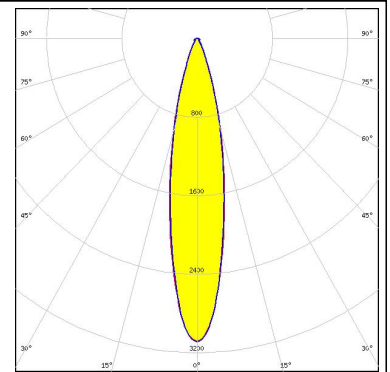
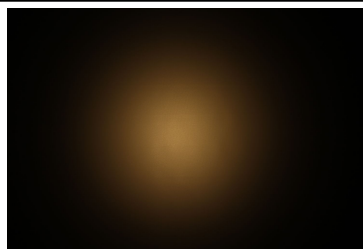

### PHOTOMETRIC DATA (MEASURED):

#### SAMSUNG

LED SLE-026/033/040  
FWHM 29.0°  
Efficiency 74 %  
Peak intensity 1.740 cd/lm  
LEDs/each optic 1  
Light colour White  
Required components:

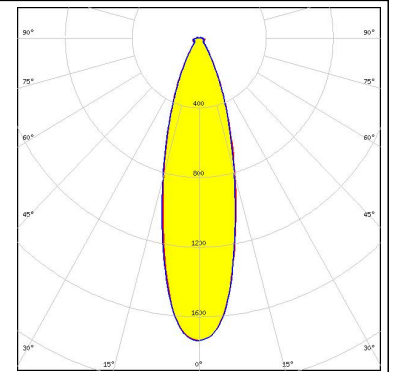
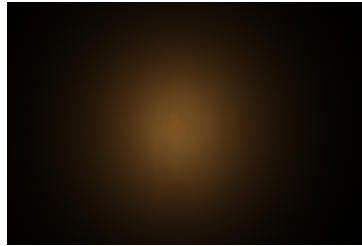

#### SHARP

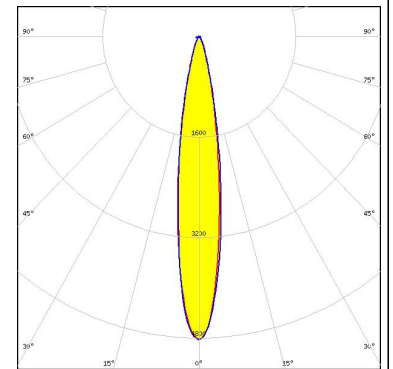
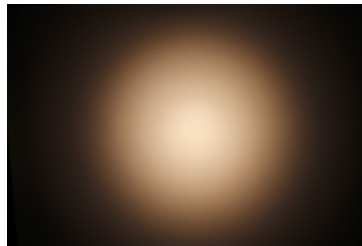

LED Mini Zenigata (GW6BM)  
FWHM 17.0°  
Efficiency 75 %  
Peak intensity 4.800 cd/lm  
LEDs/each optic 1  
Light colour White  
Required components:  
BJB: 47.319.6180



#### PHOTOMETRIC DATA (SIMULATED):

<p>bridgelux.</p> <p>LED V13 Gen7            FWHM 26.0°            Efficiency 93 %            Peak intensity 3.200 cd/lm            LEDs/each optic 1            Light colour White            Required components:            BJB: 47.319.2021</p>	
<p>bridgelux.</p> <p>LED V13 Gen7            FWHM 26.0°            Efficiency 95 %            Peak intensity 3.750 cd/lm            LEDs/each optic 1            Light colour White            Required components:            Bender Wirth: 477 Typ L1</p>	
<p>bridgelux.</p> <p>LED V13 Gen7            FWHM 24.0°            Efficiency 91 %            Peak intensity 3.240 cd/lm            LEDs/each optic 1            Light colour White            Required components:            TE: 2213254-2</p>	
<p>bridgelux.</p> <p>LED V13 Gen7            FWHM 26.0°            Efficiency 94 %            Peak intensity 3.660 cd/lm            LEDs/each optic 1            Light colour White            Required components:            TE: 2213254-1</p>	

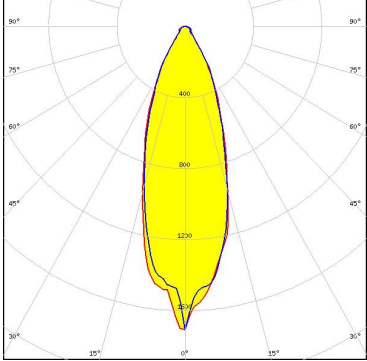
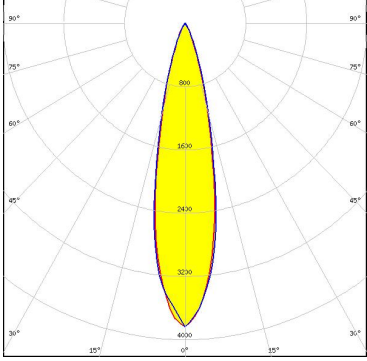
#### PHOTOMETRIC DATA (SIMULATED):

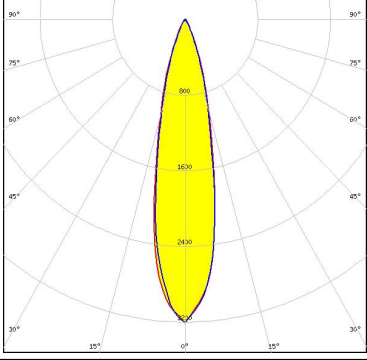
<p> <b>bridgelux</b></p> <p>LED V22 Gen7            FWHM 32.0°            Efficiency 85 %            Peak intensity 1.726 cd/lm            LEDs/each optic 1            Light colour White            Required components:            BJB: 47.319.2030</p>	
<p><b>CITIZEN</b></p> <p>LED CLL03x/CLU03x            FWHM 23.0°            Efficiency 81 %            Peak intensity 3.840 cd/lm            LEDs/each optic 1            Light colour White            Required components:            BJB: 47.319.2021</p>	
<p> <b>LUMILEDS</b></p> <p>LED LUXEON CoB 1204/1205            FWHM 23.0°            Efficiency 72 %            Peak intensity 3.530 cd/lm            LEDs/each optic 1            Light colour White            Required components:            TE: 2213130-2</p>	
<p><b>SHARP</b></p> <p>LED Mega Zenigata (GW6DME)            FWHM 29.0°            Efficiency 77 %            Peak intensity 2.400 cd/lm            LEDs/each optic 1            Light colour White            Required components:            Bender Wirth: 432 Typ Z1</p>	

### GENERAL INFORMATION:

NOTE: The typical beam angle will be changed by different color, chip size and chip position tolerance. The typical total beam angle is the full angle measured where the luminous intensity is half of the peak value.

Due to use of high power COB's with this product, special attention to proper thermal design is highly recommended. LEDiL has no liability for direct, indirect or consecutive damages arising from the LEDiL products being used outside of the recommended temperature range.

### MATERIALS:

As part of our continuous research and improvement processes, and to ensure the best possible quality and availability of our products, LEDiL reserves the right to change material grades without notice.

### PRODUCT DATA USER AGREEMENT AND DISCLAIMER:

The measured data in the provided downloadable LEDiL Product Datasheets and Mechanical 2D-Drawings is rounded and provided as reference for planning. LEDiL Oy's optical specifications have been verified by conducting performance testing of the products in accordance with the company's quality system. The reported data are averaged results of multiple measurements with typical variation. LEDiL Oy reserves the right to without prior notification make changes and improvements to its products.

LEDiL Oy assumes neither warranty, nor guarantee nor any other liability of any kind for the contents and correctness of the provided data. The provided data has been generated with highest diligence but the provided data may in reality not represent the complete possible variation range of all intrinsic parameters. Therefore, in certain cases a deviation from the provided data could occur.

LEDiL Oy reserves the right to undertake technical changes of its products without further notification which could lead to changes in the provided data. LEDiL Oy assumes no liability of any kind for the possible deviation from any provided data or any other damage resulting from the usage of the provided data.

The user agrees to this disclaimer and user agreement with the download or usage of the provided files.

**LEDiL Oy**  
Joensuunkatu 13  
FI-24240 SALO  
Finland

**LEDiL Inc.**  
228 West Page Street  
Suite D  
Sycamore IL 60178  
USA

**Local sales and technical support**  
[www.ledil.com/where\\_to\\_buy](http://www.ledil.com/where_to_buy)

**Shipping locations**  
Salo, Finland  
Hong Kong, China

**Distribution Partners**  
[www.ledil.com/where\\_to\\_buy](http://www.ledil.com/where_to_buy)



## X-ON Electronics

Largest Supplier of Electrical and Electronic Components

*Click to view similar products for [LED Lighting Lenses Assemblies](#) category:*

*Click to view products by [Ledil](#) manufacturer:*

Other Similar products are found below :

[FCN12592\\_LE1-D-COP](#) [CA16129\\_OLGA-W](#) [CA16370\\_HB-SQ-W](#) [FN15972\\_RONDA-ZT45-C](#) [CS15759\\_HB-2X2MX-8-W](#)  
[CA16435\\_LXP2-SS-WAS](#) [CN16210\\_GABRIELLA-MIDI-W](#) [CP17137\\_CARMEN-M2-C](#) [CA16015\\_STRADA-SQ-SCL](#) [CP17594\\_TINA-SC-](#)  
[RS](#) [CS15767\\_HB-2X2MX-8-M](#) [CP10960\\_RGBX-SS](#) [CP12395\\_LXP3-W](#) [CP12939\\_LARISA-RS-CLIP16](#) [C14636\\_XTM-PF-ADAPTER](#)  
[CA11819\\_STRADA-SQ-T-DW](#) [CA14508\\_G2-LXP2-D](#) [CA14601\\_VERONICA-SQ-MINI-RS](#) [FCP13895\\_SEANNA-A](#) [CP12943\\_LARISA-](#)  
[O-CLIP16](#) [FP11124\\_LISA2-O-PIN](#) [CS14597\\_HB-IP-2X6-O](#) [CP14995\\_FLORENTINA-HLD-O](#) [CS15158\\_STRADA-IP-2X6-T4-B](#)  
[CS16323\\_STRADELLA-IP-28-HB-M](#) [FN14976\\_STELLA-DWC2](#) [FN15264\\_STELLA-HB-WWW](#) [CA15584\\_ZORYA-MINI-TAPE](#)  
[FA15229\\_ROSE-MRK-S](#) [FA15232\\_ROSE-MRK-M](#) [FA15233\\_ROSE-MRK-W](#) [FCN13552\\_CRYSTAL-RS](#) [FN15552\\_RONDA-W](#)  
[FS15626\\_FLORENCE-3R-IP-Z90](#) [FS15786\\_FLORENCE-3R-IP-Z60](#) [FS15847\\_FLORENCE-3R-IP-O](#) [CA14505\\_G2-LXP2-RS2-P](#)  
[FCN12775\\_IRIS-O](#) [CP15304\\_LARISA-RS-PIN](#) [FN15679\\_RONDA-S](#) [CA15519\\_VERONICA-SQ-MINI-D](#) [FP14414\\_LISA2-O-PIN](#)  
[LL01CR-DF60L06-M2](#) [FN15993\\_RONDA-O](#) [FN15977\\_RONDA-WAS2](#) [CA14366\\_FLARE-MAXI-TAPE](#) [CA14392\\_LXP2-O-WAS](#)  
[CA14442\\_VERONICA-SQ-W](#) [CA14509\\_G2-LXP2-M-P](#) [CA15231\\_VERONICA-SQ-MINI-W](#)