

STELLA-HB

~75° high bay beam for warehouse and outdoor lighting. Compatible with up to 30 mm LES size COBs. Variant with white frame.

TECHNICAL SPECIFICATIONS:

Dimensions	Ø 90.0 mm
Height	19.5 mm
Fastening	screw
Ingress protection classes	IP67
ROHS compliant	yes ⓘ

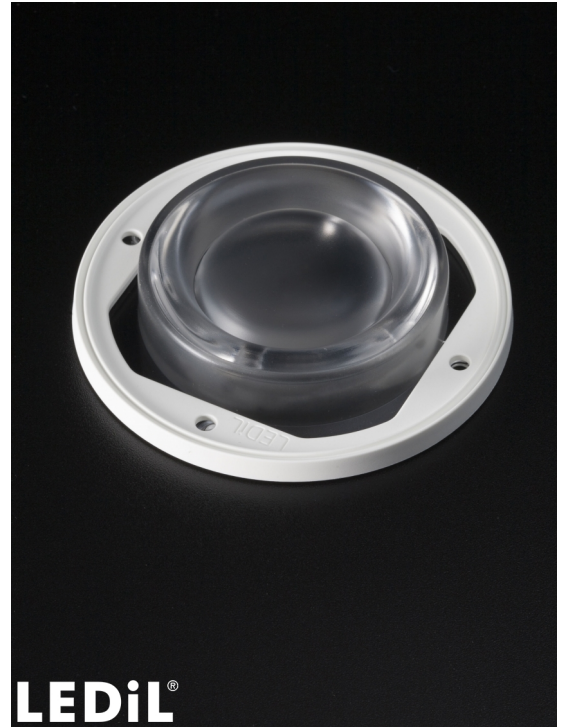

MATERIAL SPECIFICATIONS:

Component	Type	Material	Colour	Finish
STELLA-HB	Single lens	Silicone	clear	
STELLA-FRAME-WHT	Holder	PA66	white	

ORDERING INFORMATION:

Component	Type	Qty in box	MOQ	MPQ	Box weight (kg)
FN15186_STELLA-HB	Single lens	135	135	15	7.9
» Box size: 480 x 280 x 300 mm					

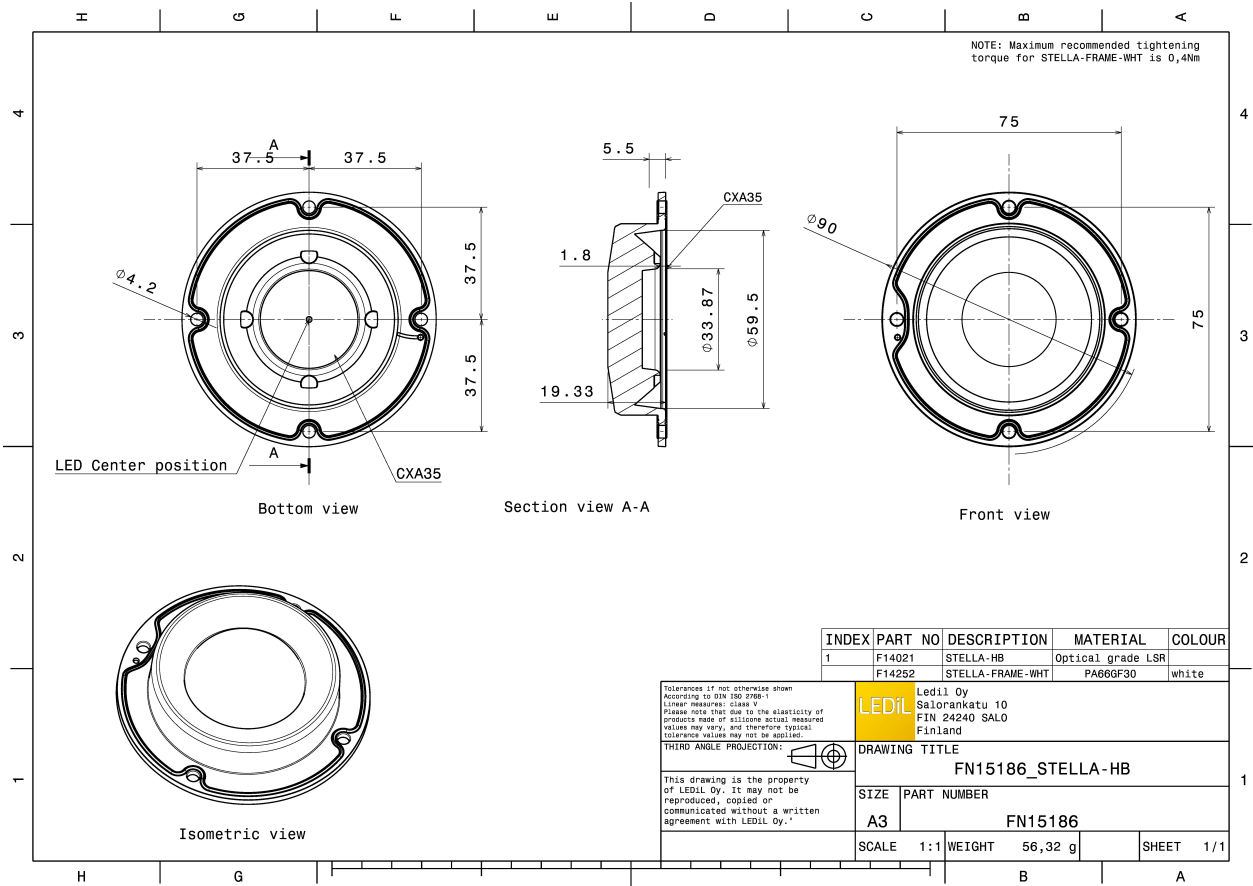

See also our general installation guide: www.ledil.com/installation_guide

PHOTOMETRIC DATA (MEASURED):

bridgelux.

LED V18 Gen7
 FWHM / FWTM 79.0° / 100.0°
 Efficiency 93 %
 Peak intensity 0.6 cd/lm
 LEDs/each optic 1
 Light colour White
 Required components:

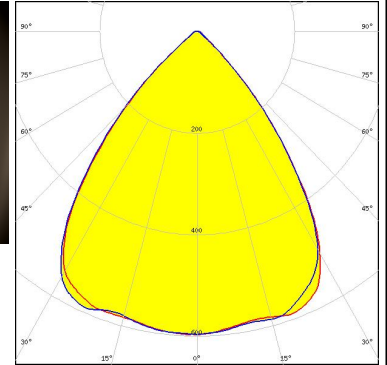

bridgelux.

LED VERO18
 FWHM / FWTM 75.0° / 96.0°
 Efficiency 93 %
 Peak intensity 0.7 cd/lm
 LEDs/each optic 1
 Light colour White
 Required components:

bridgelux.

LED VERO29
 FWHM / FWTM 69.0° / 104.0°
 Efficiency 94 %
 Peak intensity 0.7 cd/lm
 LEDs/each optic 1
 Light colour White
 Required components:

CITIZEN

LED CLL04x/CLU04x
 FWHM / FWTM 77.0° / 101.0°
 Efficiency 94 %
 Peak intensity 0.7 cd/lm
 LEDs/each optic 1
 Light colour White
 Required components:

PHOTOMETRIC DATA (MEASURED):

CITIZEN

LED CLL04x/CLU04x
FWHM / FWTM 68.0° / 94.0°
Efficiency 93 %
Peak intensity 0.8 cd/lm
LEDs/each optic 1
Light colour White
Required components:
Bender Wirth: 431 Typ L4

CITIZEN

LED CLL05x/CLU05x
FWHM / FWTM 65.0° / 103.0°
Efficiency 94 %
Peak intensity 0.7 cd/lm
LEDs/each optic 1
Light colour White
Required components:

CITIZEN

LED CLL05x/CLU05x
FWHM / FWTM 73.0° / 110.0°
Efficiency 93 %
Peak intensity 0.6 cd/lm
LEDs/each optic 1
Light colour White
Required components:

CITIZEN

LED CLL163
FWHM / FWTM 79.0° / 98.0°
Efficiency 94 %
Peak intensity 0.6 cd/lm
LEDs/each optic 1
Light colour White
Required components:

PHOTOMETRIC DATA (MEASURED):

CREE LED

LED CXA/B 1816 & CXA/B 1820 & CXA 1850
 FWHM / FWTM 87.0° / 104.0°
 Efficiency 93 %
 Peak intensity 0.6 cd/lm
 LEDs/each optic 1
 Light colour White
 Required components:

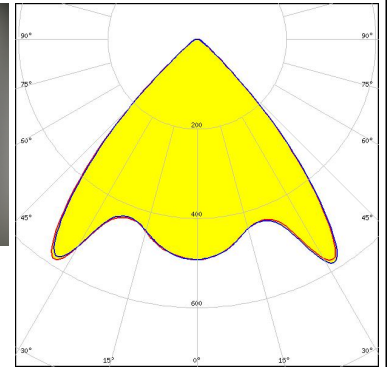
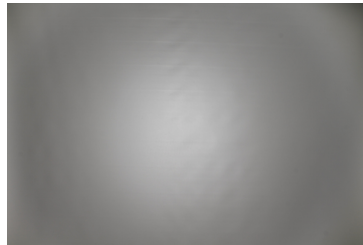

CREE LED

LED CXA/B 25xx
 FWHM / FWTM 83.0° / 102.0°
 Efficiency 93 %
 Peak intensity 0.6 cd/lm
 LEDs/each optic 1
 Light colour White
 Required components:

CREE LED

LED CXA/B 30xx
 FWHM / FWTM 78.0° / 103.0°
 Efficiency 93 %
 Peak intensity 0.6 cd/lm
 LEDs/each optic 1
 Light colour White
 Required components:

CREE LED

LED CXA/B 3590
 FWHM / FWTM 72.0° / 106.0°
 Efficiency 93 %
 Peak intensity 0.7 cd/lm
 LEDs/each optic 1
 Light colour White
 Required components:

PHOTOMETRIC DATA (MEASURED):

LITEON

LED LTPL-M074
FWHM / FWTM 76.0° / 100.0°
Efficiency 93 %
Peak intensity 0.7 cd/lm
LEDs/each optic 1
Light colour White
Required components:

LUMILEDS

LED LUXEON CoB 1211
FWHM / FWTM 71.0° / 93.0°
Efficiency 93 %
Peak intensity 0.7 cd/lm
LEDs/each optic 1
Light colour White
Required components:

LUMILEDS

LED LUXEON CoB 1216/1812
FWHM / FWTM 72.0° / 99.0°
Efficiency 94 %
Peak intensity 0.7 cd/lm
LEDs/each optic 1
Light colour White
Required components:

LUMINUS

LED CxM-18 (21.5x21.5)
FWHM / FWTM 80.0° / 100.0°
Efficiency 93 %
Peak intensity 0.6 cd/lm
LEDs/each optic 1
Light colour White
Required components:

PHOTOMETRIC DATA (MEASURED):



LED CxM-22 (28x28)
 FWHM / FWTM 68.0° / 97.0°
 Efficiency 94 %
 Peak intensity 0.8 cd/lm
 LEDs/each optic 1
 Light colour White
 Required components:
 Bender Wirth: 431 Typ L3

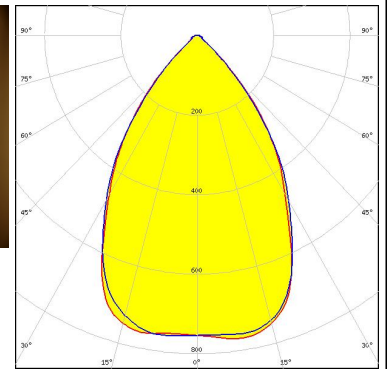
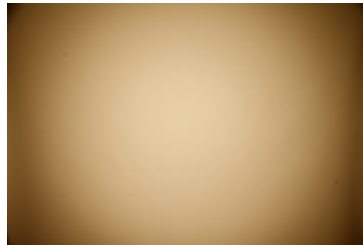

LED CxM-22 (28x28)
 FWHM / FWTM 73.0° / 100.0°
 Efficiency 93 %
 Peak intensity 0.7 cd/lm
 LEDs/each optic 1
 Light colour White
 Required components:

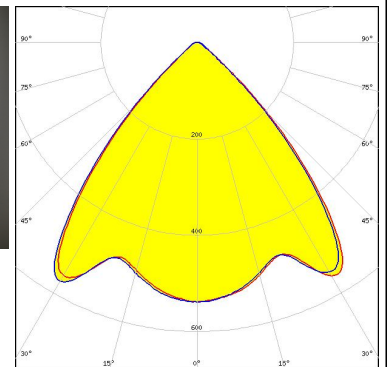

LED COB J-Type
 FWHM / FWTM 85.0° / 103.0°
 Efficiency 94 %
 Peak intensity 0.6 cd/lm
 LEDs/each optic 1
 Light colour White
 Required components:

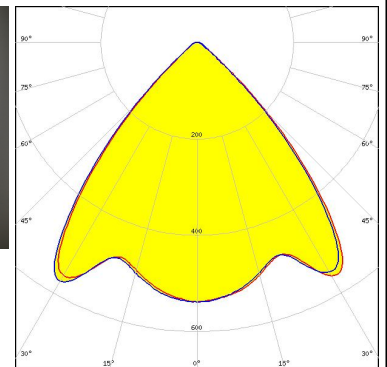

LED Soleriq S19
 FWHM / FWTM 84.0° / 101.0°
 Efficiency 92 %
 Peak intensity 0.6 cd/lm
 LEDs/each optic 1
 Light colour White
 Required components:

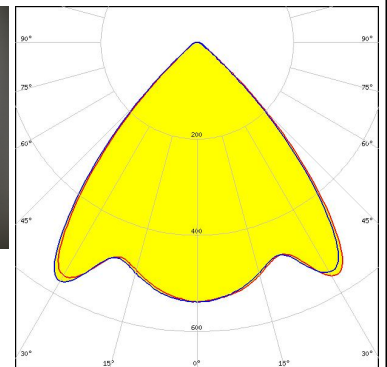

PHOTOMETRIC DATA (MEASURED):

SAMSUNG

LED LC016D / LC019D / LC026D / LC033D
 FWHM / FWTM 84.0° / 102.0°
 Efficiency 93 %
 Peak intensity 0.6 cd/lm
 LEDs/each optic 1
 Light colour White
 Required components:

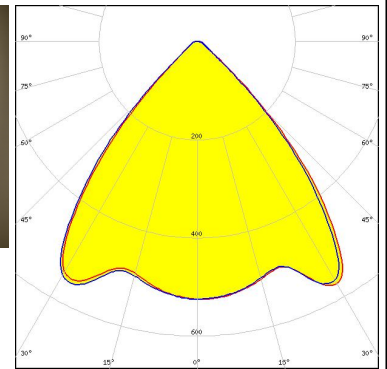
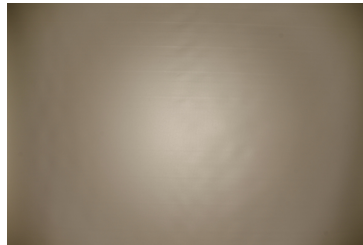

SAMSUNG

LED LC040D / LC060D / LC080D
 FWHM / FWTM 77.0° / 104.0°
 Efficiency 94 %
 Peak intensity 0.6 cd/lm
 LEDs/each optic 1
 Light colour White
 Required components:

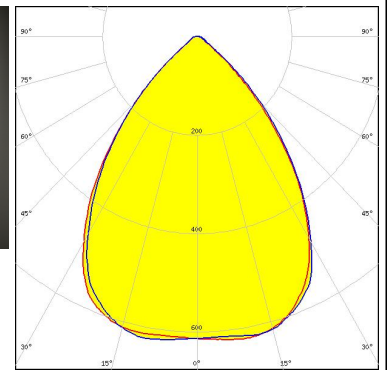
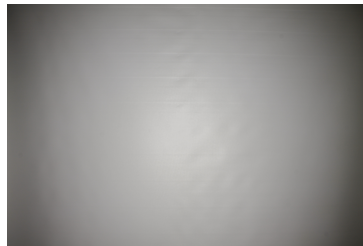

SEOUL SEMICONDUCTOR

LED MJT COB LES 33
 FWHM / FWTM 68.0° / 107.0°
 Efficiency 94 %
 Peak intensity 0.7 cd/lm
 LEDs/each optic 1
 Light colour White
 Required components:
 Bender Wirth: 458 Typ L4

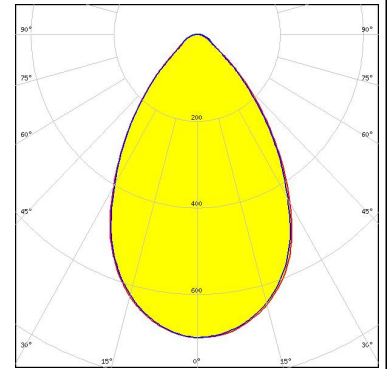

PHOTOMETRIC DATA (SIMULATED):

CITIZEN

LED	CLL03x/CLU03x
FWHM / FWTM	77.0° / 94.0°
Efficiency	96 %
Peak intensity	0.7 cd/lm
LEDs/each optic	1
Light colour	White
Required components:	

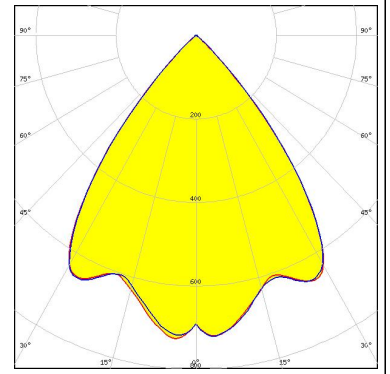

GENERAL INFORMATION:

NOTE: The typical beam angle will be changed by different color, chip size and chip position tolerance. The typical total beam angle is the full angle measured where the luminous intensity is half of the peak value.

Due to use of high power COB's with this product, special attention to proper thermal design is highly recommended. LEDiL has no liability for direct, indirect or consecutive damages arising from the LEDiL products being used outside of the recommended temperature range.

MATERIALS:

As part of our continuous research and improvement processes, and to ensure the best possible quality and availability of our products, LEDiL reserves the right to change material grades without notice.

PRODUCT DATA USER AGREEMENT AND DISCLAIMER:

The measured data in the provided downloadable LEDiL Product Datasheets and Mechanical 2D-Drawings is rounded and provided as reference for planning. LEDiL Oy's optical specifications have been verified by conducting performance testing of the products in accordance with the company's quality system. The reported data are averaged results of multiple measurements with typical variation. LEDiL Oy reserves the right to without prior notification make changes and improvements to its products.

LEDiL Oy assumes neither warranty, nor guarantee nor any other liability of any kind for the contents and correctness of the provided data. The provided data has been generated with highest diligence but the provided data may in reality not represent the complete possible variation range of all intrinsic parameters. Therefore, in certain cases a deviation from the provided data could occur.

LEDiL Oy reserves the right to undertake technical changes of its products without further notification which could lead to changes in the provided data. LEDiL Oy assumes no liability of any kind for the possible deviation from any provided data or any other damage resulting from the usage of the provided data.

The user agrees to this disclaimer and user agreement with the download or usage of the provided files.

LEDiL Oy

Joensuunkatu 13
FI-24240 SALO
Finland

LEDiL Inc.

228 West Page Street
Suite D
Sycamore IL 60178
USA

Ledil Optics Technology (Shenzhen) Co., Ltd.

405 , Block B
Casic Motor Building
Shenzhen 518057
P.R.CHINA

Local sales and technical support

[www.ledil.com/
where_to_buy](http://www.ledil.com/where_to_buy)

Shipping locations

Salo, Finland
Hong Kong, China

Distribution Partners

[www.ledil.com/
where_to_buy](http://www.ledil.com/where_to_buy)

X-ON Electronics

Largest Supplier of Electrical and Electronic Components

Click to view similar products for [LED Lighting Lenses Assemblies](#) category:

Click to view products by [Ledil](#) manufacturer:

Other Similar products are found below :

[FCN12592_LE1-D-COP](#) [CA16129_OLGA-W](#) [CA16370_HB-SQ-W](#) [FN15972_RONDA-ZT45-C](#) [CS15759_HB-2X2MX-8-W](#)
[CA16435_LXP2-SS-WAS](#) [CN16210_GABRIELLA-MIDI-W](#) [CP17137_CARMEN-M2-C](#) [CA16015_STRADA-SQ-SCL](#) [CP17594_TINA-SC-](#)
[RS](#) [CS15767_HB-2X2MX-8-M](#) [CP10960_RGBX-SS](#) [CP12395_LXP3-W](#) [CP12939_LARISA-RS-CLIP16](#) [C14636_XTM-PF-ADAPTER](#)
[CA11819_STRADA-SQ-T-DW](#) [CA14508_G2-LXP2-D](#) [CA14601_VERONICA-SQ-MINI-RS](#) [FCP13895_SEANNA-A](#) [CP12943_LARISA-](#)
[O-CLIP16](#) [FP11124_LISA2-O-PIN](#) [CS14597_HB-IP-2X6-O](#) [CP14995_FLORENTINA-HLD-O](#) [CS15158_STRADA-IP-2X6-T4-B](#)
[CS16323_STRADELLA-IP-28-HB-M](#) [FN14976_STELLA-DWC2](#) [FN15264_STELLA-HB-WWW](#) [CA15584_ZORYA-MINI-TAPE](#)
[FA15229_ROSE-MRK-S](#) [FA15232_ROSE-MRK-M](#) [FA15233_ROSE-MRK-W](#) [FCN13552_CRYSTAL-RS](#) [FN15552_RONDA-W](#)
[FS15626_FLORENCE-3R-IP-Z90](#) [FS15786_FLORENCE-3R-IP-Z60](#) [FS15847_FLORENCE-3R-IP-O](#) [CA14505_G2-LXP2-RS2-P](#)
[FCN12775_IRIS-O](#) [CP15304_LARISA-RS-PIN](#) [FN15679_RONDA-S](#) [CA15519_VERONICA-SQ-MINI-D](#) [FP14414_LISA2-O-PIN](#)
[LL01CR-DF60L06-M2](#) [FN15993_RONDA-O](#) [FN15977_RONDA-WAS2](#) [CA14366_FLARE-MAXI-TAPE](#) [CA14442_VERONICA-SQ-W](#)
[CA14509_G2-LXP2-M-P](#) [CA15231_VERONICA-SQ-MINI-W](#) [FP11002_LISA2-W-PIN](#)