

STELLA-HB-WWW

~100° very wide beam for warehouse and outdoor lighting. Compatible with up to 30 mm LES size COBs. Variant with black frame.

TECHNICAL SPECIFICATIONS:

Dimensions	Ø 90.0 mm
Height	11.3 mm
Fastening	screw
Ingress protection classes	IP67
ROHS compliant	yes ⓘ



MATERIAL SPECIFICATIONS:

Component	Type	Material	Colour	Finish
STELLA-HB-WWW	Single lens	Silicone	clear	
STELLA-FRAME	Holder	PA66	black	





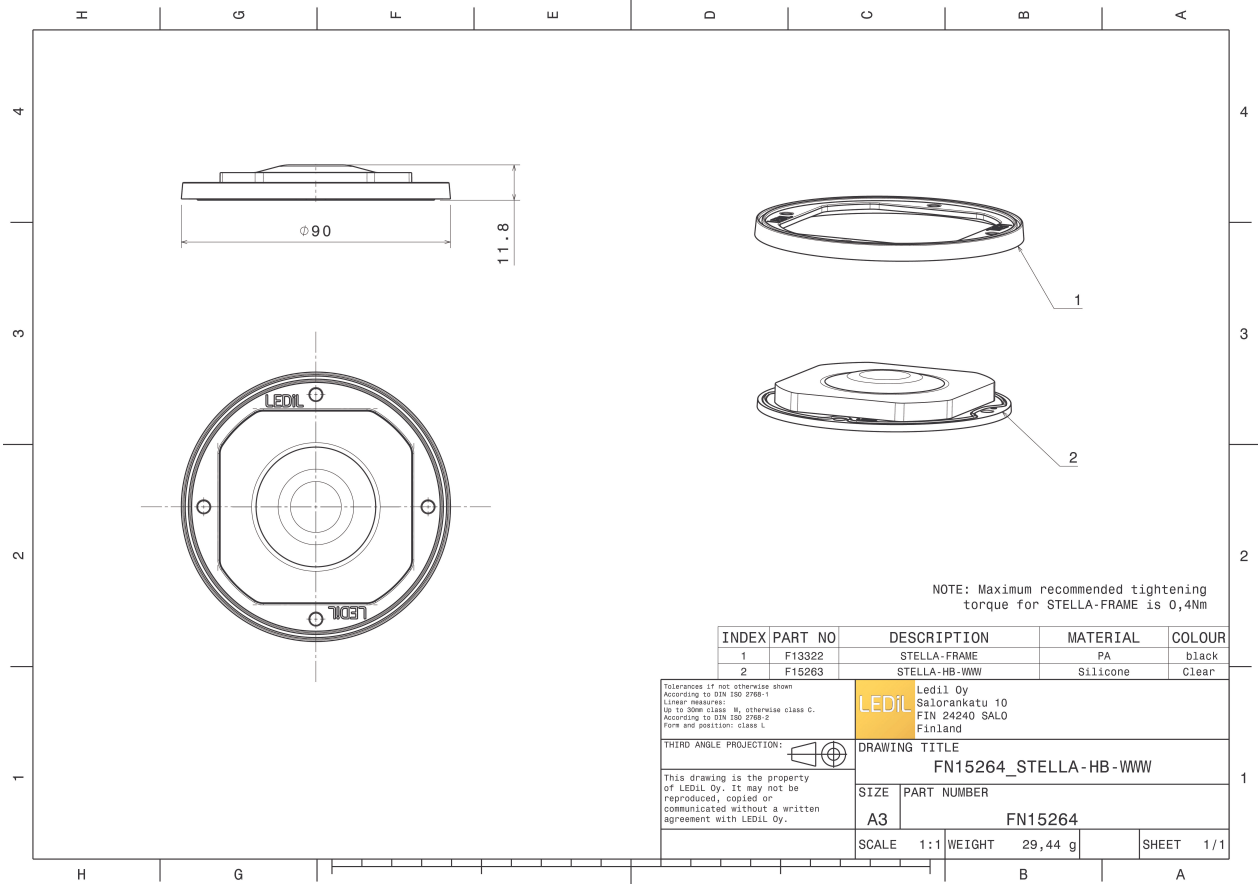



ORDERING INFORMATION:

Component		Qty in box	MOQ	MPQ	Box weight (kg)
FN15264_STELLA-HB-WWW	Single lens	135	135	15	5.0
» Box size: 480 x 280 x 300 mm					

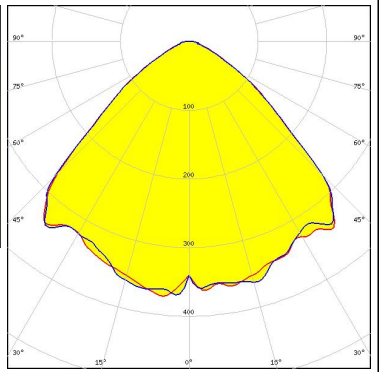

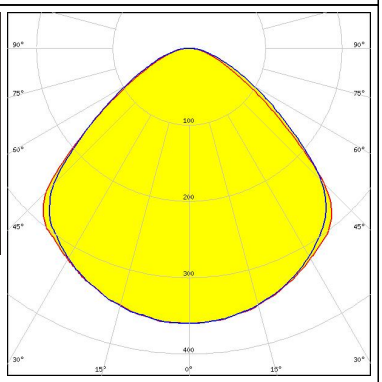

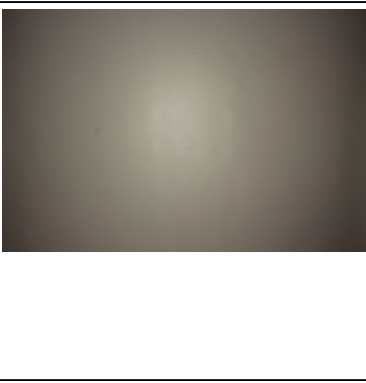
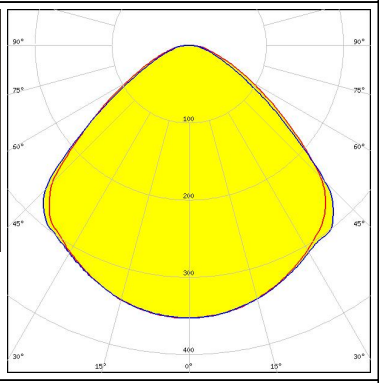

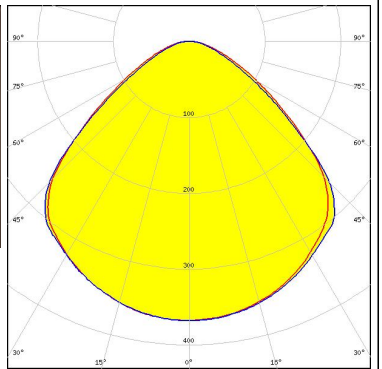
See also our general installation guide: www.ledil.com/installation_guide

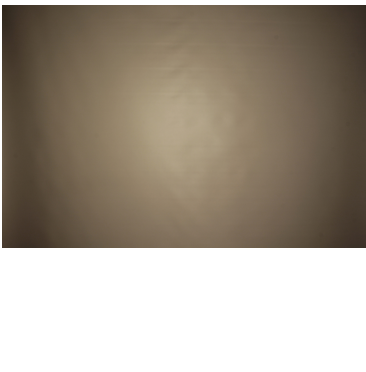
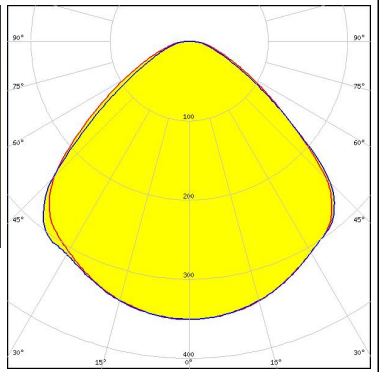
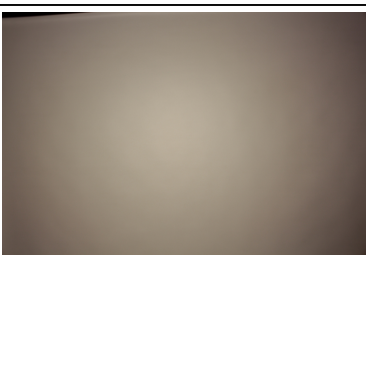
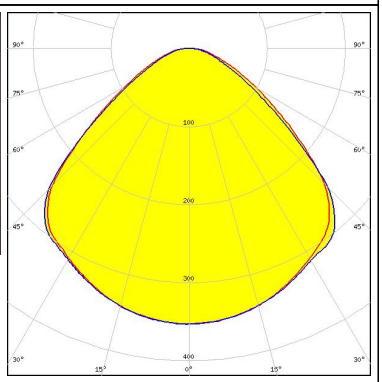

PHOTOMETRIC DATA (MEASURED):

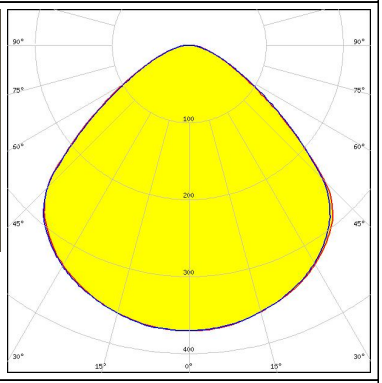
<p></p> <p>LED V18 Gen7 FWHM / FWTM 102.0° / 145.0° Efficiency 87 % Peak intensity 0.4 cd/lm LEDs/each optic 1 Light colour White Required components: BJB: 47.319.2350</p>		
<p></p> <p>LED V18 Gen7 FWHM / FWTM 102.0° / 144.0° Efficiency 90 % Peak intensity 0.4 cd/lm LEDs/each optic 1 Light colour White Required components: Bender Wirth: 439 Typ L3</p>		
<p></p> <p>LED V18 Gen7 FWHM / FWTM 101.0° / 144.0° Efficiency 88 % Peak intensity 0.4 cd/lm LEDs/each optic 1 Light colour White Required components:</p>		
<p></p> <p>LED V22 Gen7 FWHM / FWTM 102.0° / 146.0° Efficiency 92 % Peak intensity 0.4 cd/lm LEDs/each optic 1 Light colour White Required components: TE Connectivity: 2213480-1</p>		

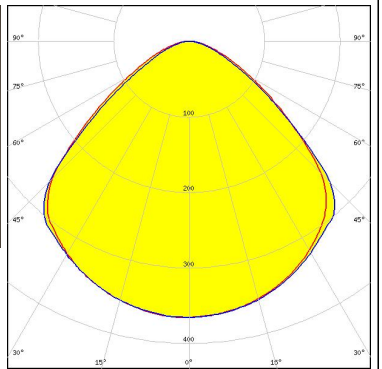
PHOTOMETRIC DATA (MEASURED):

<p>bridgelux.</p> <p>LED V22 Gen7</p> <p>FWHM / FWTM 101.0° / 147.0°</p> <p>Efficiency 87 %</p> <p>Peak intensity 0.4 cd/lm</p> <p>LEDs/each optic 1</p> <p>Light colour White</p> <p>Required components:</p>		
<p>bridgelux.</p> <p>LED V22 Gen7</p> <p>FWHM / FWTM 102.0° / 147.0°</p> <p>Efficiency 89 %</p> <p>Peak intensity 0.4 cd/lm</p> <p>LEDs/each optic 1</p> <p>Light colour White</p> <p>Required components: Bender Wirth: 431 Typ Z1</p>		
<p>bridgelux.</p> <p>LED Vero SE 13</p> <p>FWHM / FWTM 101.0° / 142.0°</p> <p>Efficiency 90 %</p> <p>Peak intensity 0.4 cd/lm</p> <p>LEDs/each optic 1</p> <p>Light colour White</p> <p>Required components:</p>		
<p>bridgelux.</p> <p>LED Vero SE 18</p> <p>FWHM / FWTM 101.0° / 144.0°</p> <p>Efficiency 90 %</p> <p>Peak intensity 0.4 cd/lm</p> <p>LEDs/each optic 1</p> <p>Light colour White</p> <p>Required components:</p>		

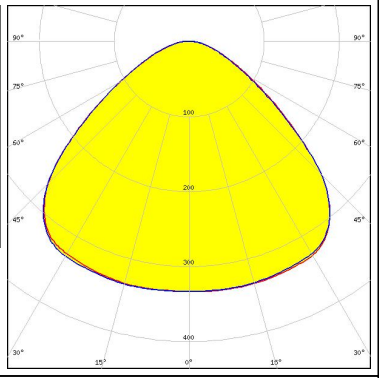
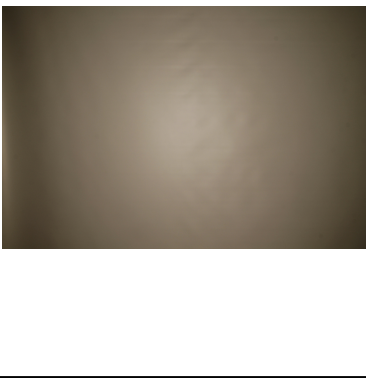
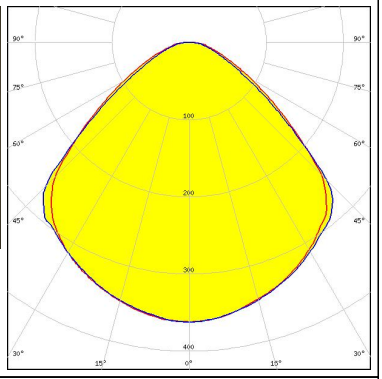
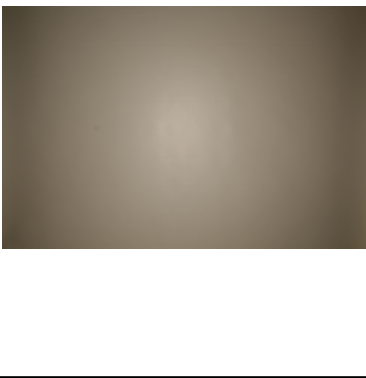
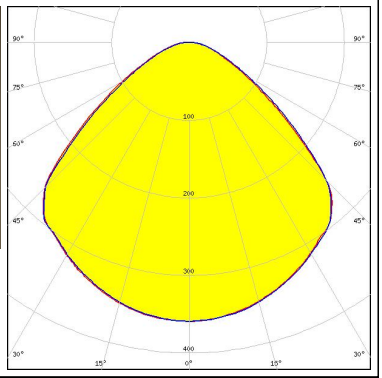
PHOTOMETRIC DATA (MEASURED):

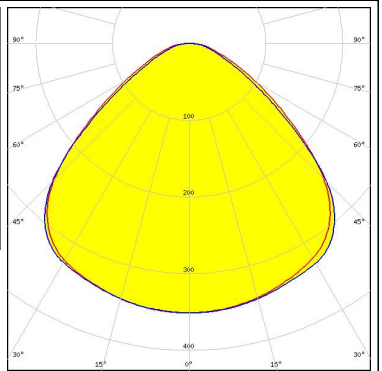
<p>bridgelux.</p> <p>LED Vero SE 29</p> <p>FWHM / FWTM 105.0° / 149.0°</p> <p>Efficiency 92 %</p> <p>Peak intensity 0.3 cd/lm</p> <p>LEDs/each optic 1</p> <p>Light colour White</p> <p>Required components:</p>		
<p>bridgelux.</p> <p>LED VERO13</p> <p>FWHM / FWTM 100.0° / 145.0°</p> <p>Efficiency 88 %</p> <p>Peak intensity 0.4 cd/lm</p> <p>LEDs/each optic 1</p> <p>Light colour White</p> <p>Required components:</p>		
<p>bridgelux.</p> <p>LED VERO18</p> <p>FWHM / FWTM 102.0° / 144.0°</p> <p>Efficiency 89 %</p> <p>Peak intensity 0.4 cd/lm</p> <p>LEDs/each optic 1</p> <p>Light colour White</p> <p>Required components:</p>		
<p>bridgelux.</p> <p>LED VERO29</p> <p>FWHM / FWTM 103.0° / 148.0°</p> <p>Efficiency 91 %</p> <p>Peak intensity 0.4 cd/lm</p> <p>LEDs/each optic 1</p> <p>Light colour White</p> <p>Required components:</p>		

PHOTOMETRIC DATA (MEASURED):

CITIZEN

LED CLL02x/CLU02x (LES10)
 FWHM / FWTM 100.0° / 143.0°
 Efficiency 92 %
 Peak intensity 0.4 cd/lm
 LEDs/each optic 1
 Light colour White
 Required components:
 F15255_HEKLA-SOCKET-C

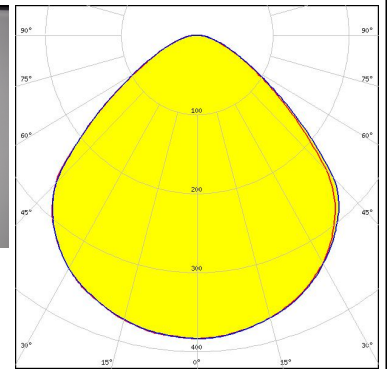

CITIZEN

LED CLL02x/CLU02x (LES10)
 FWHM / FWTM 100.0° / 142.0°
 Efficiency 88 %
 Peak intensity 0.4 cd/lm
 LEDs/each optic 1
 Light colour White
 Required components:

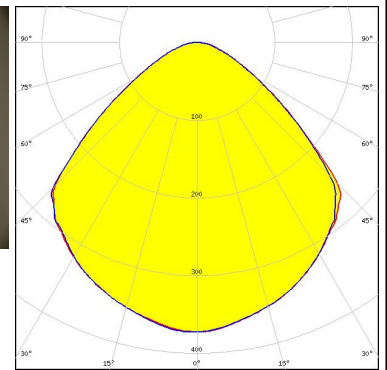
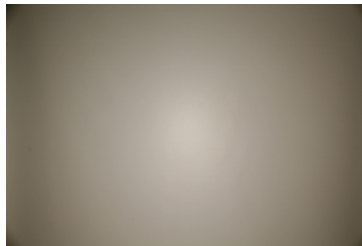

CITIZEN

LED CLL04x/CLU04x
 FWHM / FWTM 102.0° / 144.0°
 Efficiency 89 %
 Peak intensity 0.4 cd/lm
 LEDs/each optic 1
 Light colour White
 Required components:

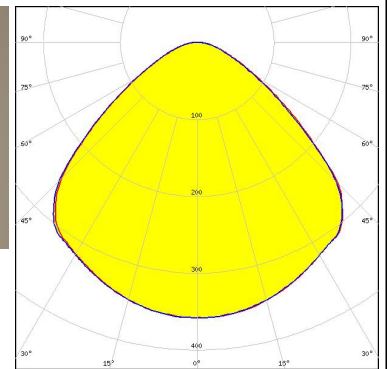

CREE LED

LED CMA2550
 FWHM / FWTM 102.0° / 145.0°
 Efficiency 88 %
 Peak intensity 0.4 cd/lm
 LEDs/each optic 1
 Light colour White
 Required components:

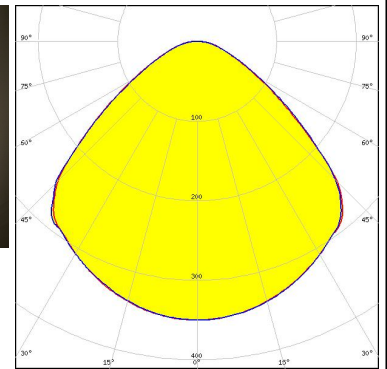
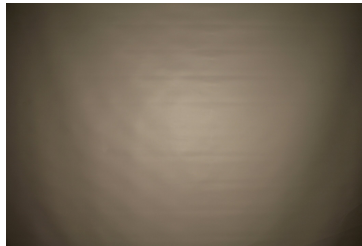

PHOTOMETRIC DATA (MEASURED):

CREE LED

LED CMA3090
 FWHM / FWTM 102.0° / 147.0°
 Efficiency 88 %
 Peak intensity 0.3 cd/lm
 LEDs/each optic 1
 Light colour White
 Required components:

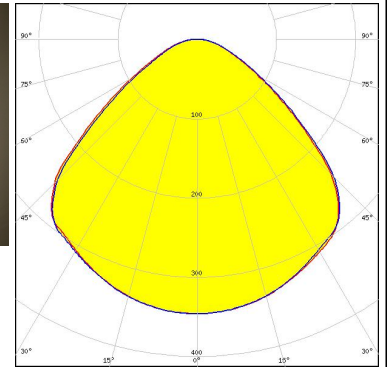

CREE LED

LED CMT19xx
 FWHM / FWTM 101.0° / 145.0°
 Efficiency 89 %
 Peak intensity 0.4 cd/lm
 LEDs/each optic 1
 Light colour White
 Required components:
 Bender Wirth: 477 Typ Z1

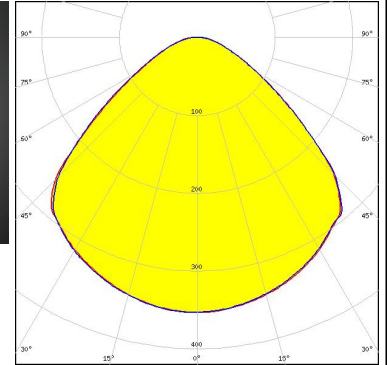
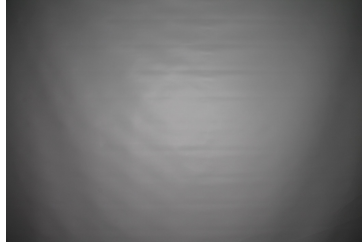

CREE LED

LED CXA/B 1816 & CXA/B 1820 & CXA 1850
 FWHM / FWTM 102.0° / 146.0°
 Efficiency 87 %
 Peak intensity 0.4 cd/lm
 LEDs/each optic 1
 Light colour White
 Required components:

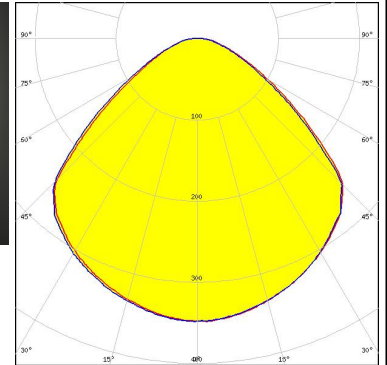

CREE LED

LED CXA/B 1830
 FWHM / FWTM 102.0° / 145.0°
 Efficiency 88 %
 Peak intensity 0.4 cd/lm
 LEDs/each optic 1
 Light colour White
 Required components:
 C14305_STELLA-CLAMP-CXA15-18

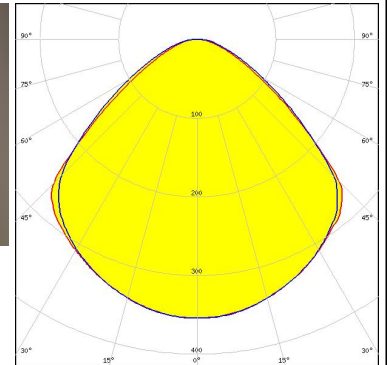

PHOTOMETRIC DATA (MEASURED):

CREE LED

LED CXA/B 25xx
 FWHM / FWTM 102.0° / 144.0°
 Efficiency 88 %
 Peak intensity 0.4 cd/lm
 LEDs/each optic 1
 Light colour White
 Required components:

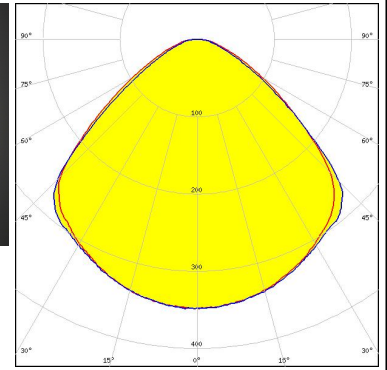

CREE LED

LED CXA/B 25xx
 FWHM / FWTM 101.0° / 145.0°
 Efficiency 90 %
 Peak intensity 0.4 cd/lm
 LEDs/each optic 1
 Light colour White
 Required components:
 Bender Wirth: 439 Typ L3

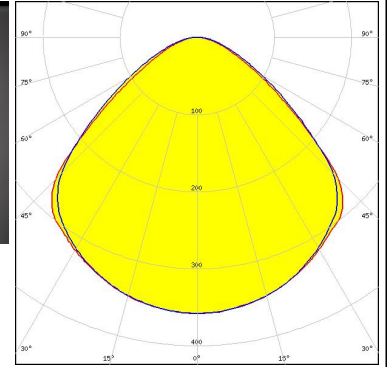

CREE LED

LED CXA/B 30xx
 FWHM / FWTM 102.0° / 144.0°
 Efficiency 88 %
 Peak intensity 0.4 cd/lm
 LEDs/each optic 1
 Light colour White
 Required components:

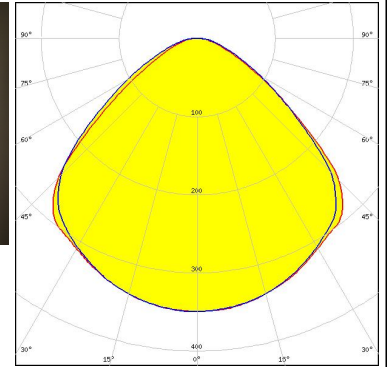



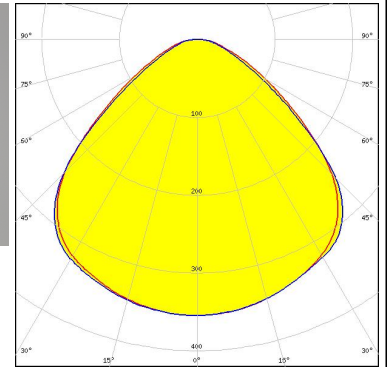

CREE LED

LED CXA/B 3590
 FWHM / FWTM 102.0° / 147.0°
 Efficiency 90 %
 Peak intensity 0.4 cd/lm
 LEDs/each optic 1
 Light colour White
 Required components:

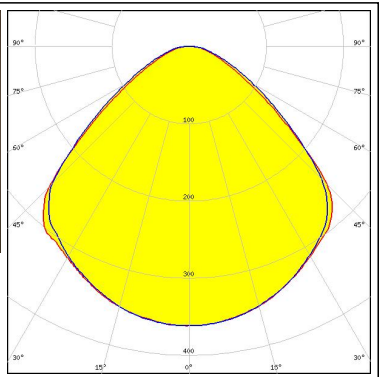

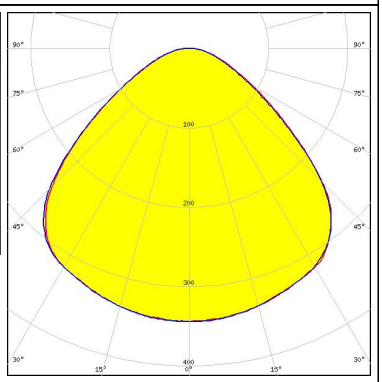
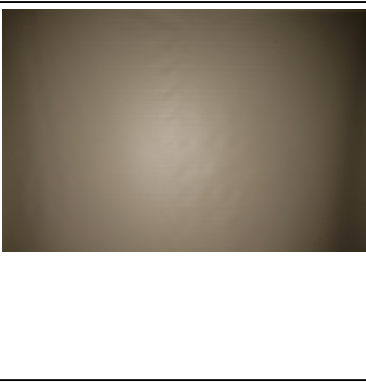
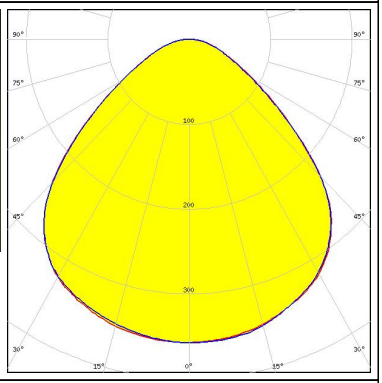
PHOTOMETRIC DATA (MEASURED):

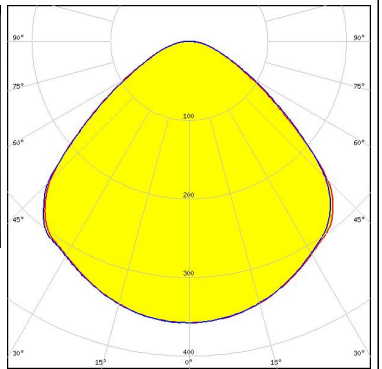
<p>LUMILEDS</p> <p>LED LUXEON CoB 1211</p> <p>FWHM / FWTM 101.0° / 144.0°</p> <p>Efficiency 89 %</p> <p>Peak intensity 0.4 cd/m</p> <p>LEDs/each optic 1</p> <p>Light colour White</p> <p>Required components: Bender Wirth: 431 Typ L3</p>		
<p>LUMILEDS</p> <p>LED LUXEON CoB 1321</p> <p>FWHM / FWTM 102.0° / 149.0°</p> <p>Efficiency 89 %</p> <p>Peak intensity 0.3 cd/m</p> <p>LEDs/each optic 1</p> <p>Light colour White</p> <p>Required components:</p>		
<p>LUMILEDS</p> <p>LED LUXEON CoB 1825</p> <p>FWHM / FWTM 100.0° / 147.0°</p> <p>Efficiency 88 %</p> <p>Peak intensity 0.4 cd/m</p> <p>LEDs/each optic 1</p> <p>Light colour White</p> <p>Required components:</p>		
<p>NICHIA</p> <p>LED COB H-Type</p> <p>FWHM / FWTM 101.0° / 146.0°</p> <p>Efficiency 89 %</p> <p>Peak intensity 0.4 cd/m</p> <p>LEDs/each optic 1</p> <p>Light colour White</p> <p>Required components:</p>		

PHOTOMETRIC DATA (MEASURED):

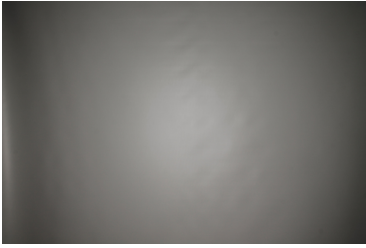
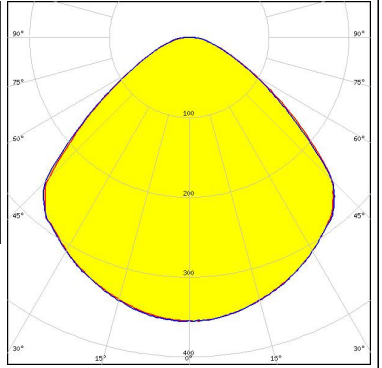
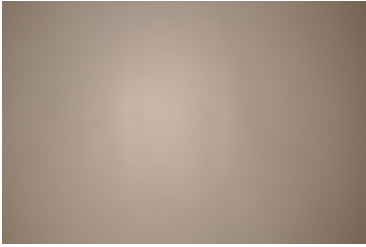
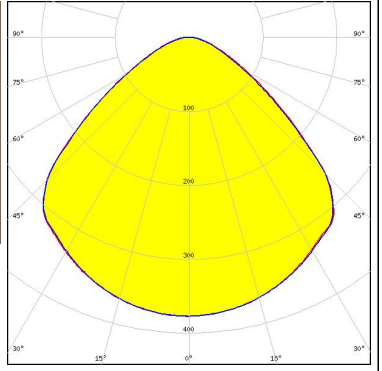
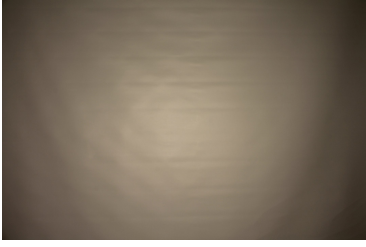
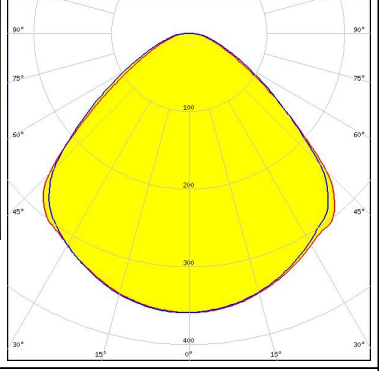
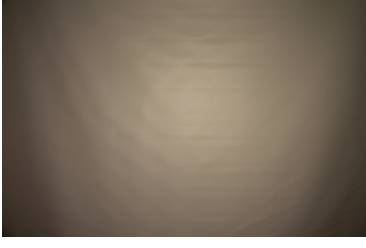
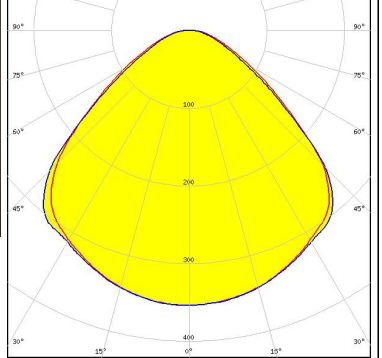
<p>NICHIA</p> <p>LED COB J-Type FWHM / FWTM 102.0° / 145.0° Efficiency 88 % Peak intensity 0.4 cd/lm LEDs/each optic 1 Light colour White Required components:</p>		
<p>PHILIPS</p> <p>LED Fortimo SLM L19 + SLM holder (PI) FWHM / FWTM 101.0° / 142.0° Efficiency 93 % Peak intensity 0.4 cd/lm LEDs/each optic 1 Light colour White Required components:</p>		
<p>PHILIPS</p> <p>LED Fortimo SLM L19 CoB FWHM / FWTM 100.0° / 144.0° Efficiency 88 % Peak intensity 0.4 cd/lm LEDs/each optic 1 Light colour White Required components: Bender Wirth: 431 Typ Z1</p>		
<p>PHILIPS</p> <p>LED Fortimo SLM L23 CoB FWHM / FWTM 145.0° / 100.0° Efficiency 88 % Peak intensity 0.4 cd/lm LEDs/each optic 1 Light colour White Required components: Bender Wirth: 431 Typ Z1</p>		

PHOTOMETRIC DATA (MEASURED):

SAMSUNG

LED LC040D / LC060D / LC080D
 FWHM / FWTM 102.0° / 144.0°
 Efficiency 88 %
 Peak intensity 0.4 cd/lm
 LEDs/each optic 1
 Light colour White
 Required components:

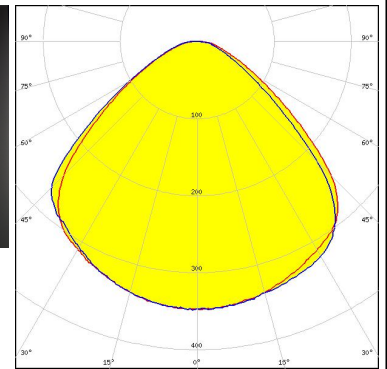
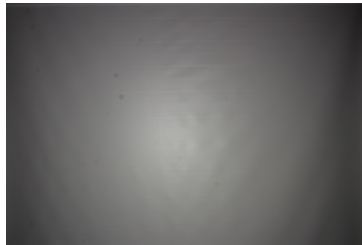

SEOUL SEMICONDUCTOR
 LED MJT COB LES 14.5
 FWHM / FWTM 101.0° / 145.0°
 Efficiency 90 %
 Peak intensity 0.5 cd/lm
 LEDs/each optic 1
 Light colour White
 Required components:
 Bender Wirth: 433 Typ Z1

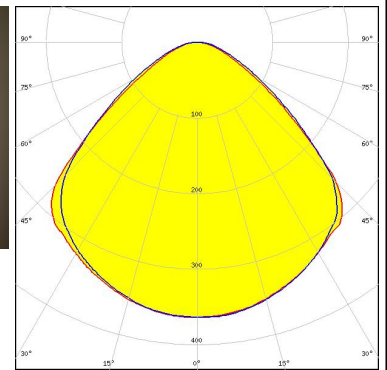
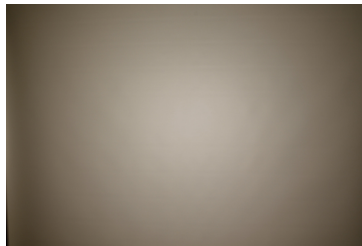



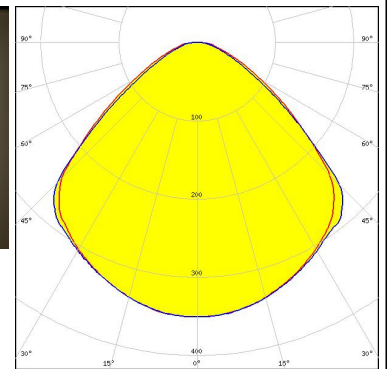

SEOUL SEMICONDUCTOR
 LED MJT COB LES 14.5
 FWHM / FWTM 101.0° / 141.0°
 Efficiency 87 %
 Peak intensity 0.4 cd/lm
 LEDs/each optic 1
 Light colour White
 Required components:

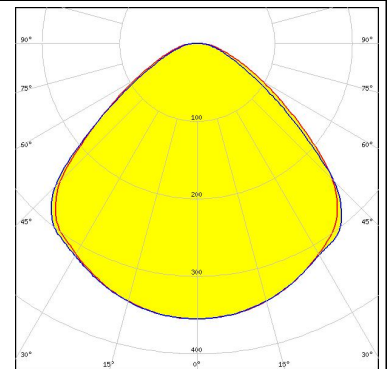



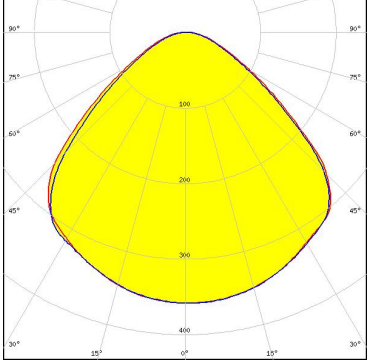

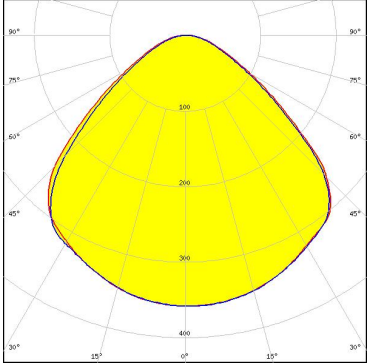

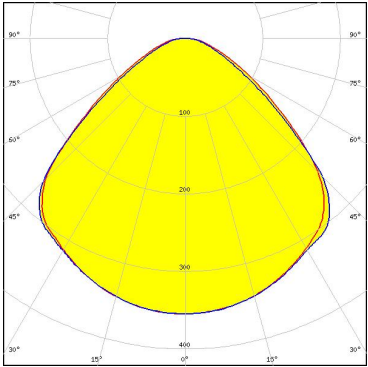
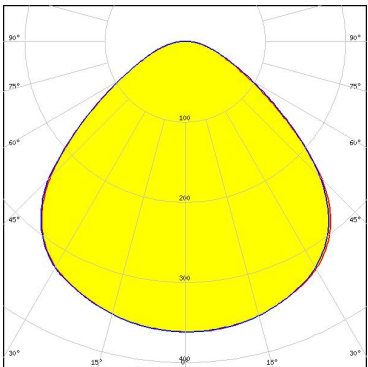
SEOUL SEMICONDUCTOR
 LED MJT COB LES 22
 FWHM / FWTM 101.0° / 145.0°
 Efficiency 89 %
 Peak intensity 0.4 cd/lm
 LEDs/each optic 1
 Light colour White
 Required components:
 Bender Wirth: 431 Typ Z1

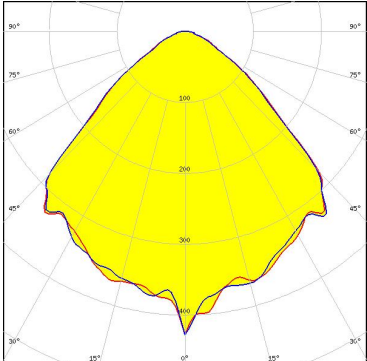

PHOTOMETRIC DATA (MEASURED):

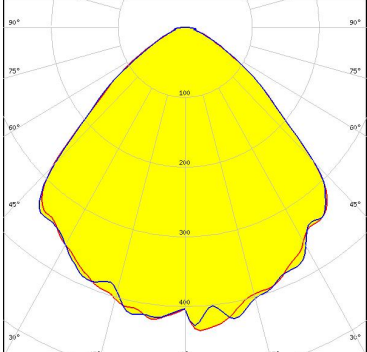
<p>SEOUL SEMICONDUCTOR</p> <p>LED MJT COB LES 22</p> <p>FWHM / FWTM 101.0° / 146.0°</p> <p>Efficiency 89 %</p> <p>Peak intensity 0.4 cd/m</p> <p>LEDs/each optic 1</p> <p>Light colour White</p> <p>Required components: IDEAL: 50-2204CT</p>		
<p>SEOUL SEMICONDUCTOR</p> <p>LED MJT COB LES 22</p> <p>FWHM / FWTM 101.0° / 146.0°</p> <p>Efficiency 89 %</p> <p>Peak intensity 0.4 cd/m</p> <p>LEDs/each optic 1</p> <p>Light colour White</p> <p>Required components: IDEAL: 50-2204CT</p>		
<p>SEOUL SEMICONDUCTOR</p> <p>LED MJT COB LES 22</p> <p>FWHM / FWTM 101.0° / 145.0°</p> <p>Efficiency 89 %</p> <p>Peak intensity 0.4 cd/m</p> <p>LEDs/each optic 1</p> <p>Light colour White</p> <p>Required components: Bender Wirth: 431 Typ Z1</p>		
<p>SEOUL SEMICONDUCTOR</p> <p>LED MJT COB LES 33</p> <p>FWHM / FWTM 101.0° / 147.0°</p> <p>Efficiency 90 %</p> <p>Peak intensity 0.4 cd/m</p> <p>LEDs/each optic 1</p> <p>Light colour White</p> <p>Required components: Bender Wirth: 458 Typ L4</p>		

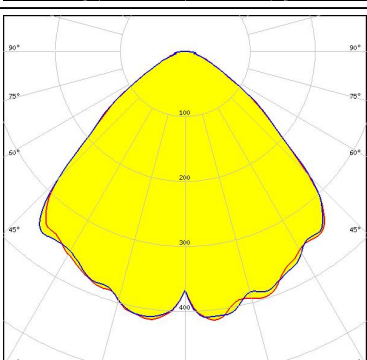
PHOTOMETRIC DATA (SIMULATED):

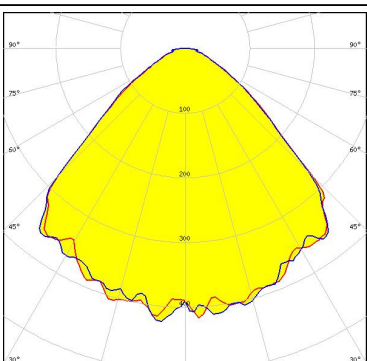
<p></p> <p>LED V10 Gen7 FWHM / FWTM 95.0° / 132.0° Efficiency 88 % Peak intensity 0.4 cd/lm LEDs/each optic 1 Light colour White Required components: Bender Wirth: 486 Typ L1</p>	
<p></p> <p>LED V13 Gen7 FWHM / FWTM 94.0° / 130.0° Efficiency 94 % Peak intensity 0.4 cd/lm LEDs/each optic 1 Light colour White Required components:</p>	
<p></p> <p>LED V13 Gen7 FWHM / FWTM 94.0° / 132.0° Efficiency 94 % Peak intensity 0.4 cd/lm LEDs/each optic 1 Light colour White Required components: Bender Wirth: 477 Typ Z1</p>	
<p></p> <p>LED V22 Gen7 FWHM / FWTM 96.0° / 132.0° Efficiency 94 % Peak intensity 0.5 cd/lm LEDs/each optic 1 Light colour White Required components: IDEAL: 50-2204CT</p>	

PHOTOMETRIC DATA (SIMULATED):

CITIZEN

LED CLL03x/CLU03x
 FWHM / FWTM 98.0° / 133.0°
 Efficiency 90 %
 Peak intensity 0.4 cd/lm
 LEDs/each optic 1
 Light colour White
 Required components:

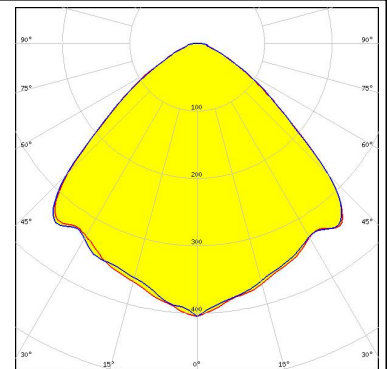

CITIZEN

LED CLL05x/CLU05x
 FWHM / FWTM 97.0° / 137.0°
 Efficiency 87 %
 Peak intensity 0.4 cd/lm
 LEDs/each optic 1
 Light colour White
 Required components:

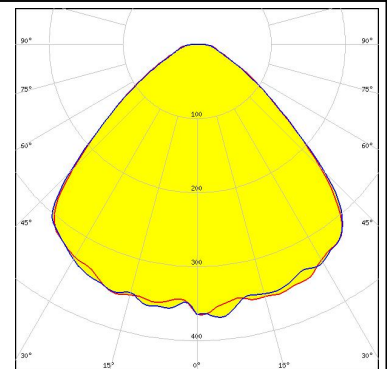

CREE LED

LED CMT28xx
 FWHM / FWTM 99.0° / 132.0°
 Efficiency 88 %
 Peak intensity 0.4 cd/lm
 LEDs/each optic 1
 Light colour White
 Required components:

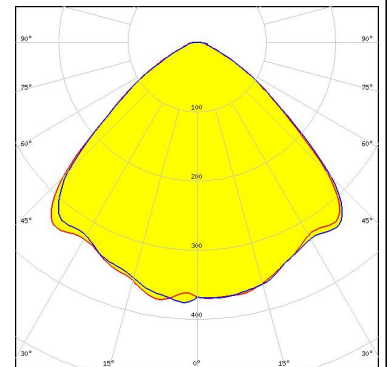

LITEON

LED LTPL-G35UV275GR-E
 FWHM / FWTM 92.0° / 127.0°
 Efficiency 71 %
 LEDs/each optic 13
 Light colour UV-C
 Required components:

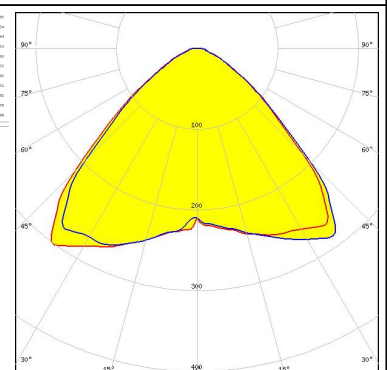
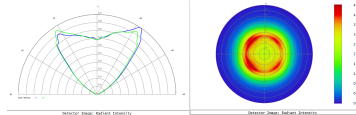

The UVC LED result tolerance is ±10 %

PHOTOMETRIC DATA (SIMULATED):

LITEON

LED LTPL-G35UV275GR-E
 FWHM / FWTM 92.0° / 129.0°
 Efficiency 70 %
 LEDs/each optic 4
 Light colour UV-C
 Required components:

The UVC LED result tolerance is ± 10 %

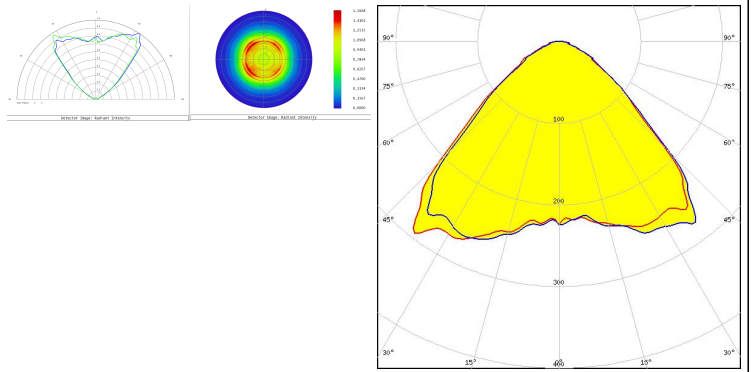

LITEON

LED LTPL-G35UV275GR-E
 FWHM / FWTM 92.0° / 129.0°
 Efficiency 70 %
 LEDs/each optic 3
 Light colour UV-C
 Required components:

The UVC LED result tolerance is ± 10 %

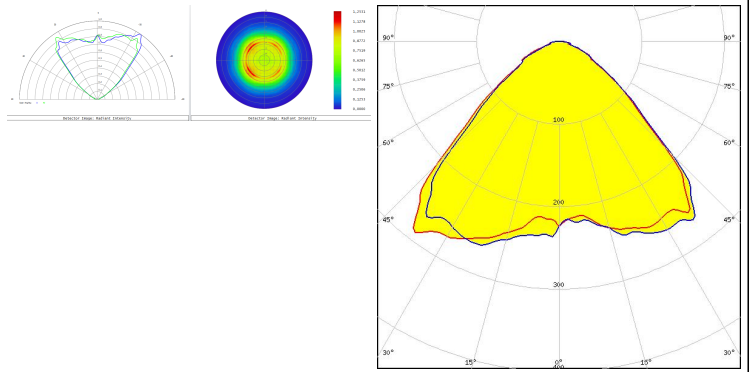

LUMILEDS

LED LUXEON CoB 1216/1812
 FWHM / FWTM 99.0° / 136.0°
 Efficiency 91 %
 Peak intensity 0.4 cd/lm
 LEDs/each optic 1
 Light colour White
 Required components:
 Bender Wirth: 431 Typ L4

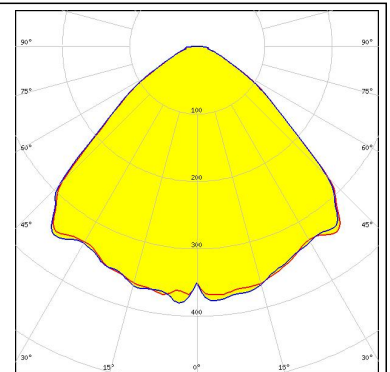



LUMINUS

LED XBT-3535-UV
 FWHM / FWTM 100.0° / 127.0°
 Efficiency 70 %
 LEDs/each optic 1
 Light colour UV-C
 Required components:

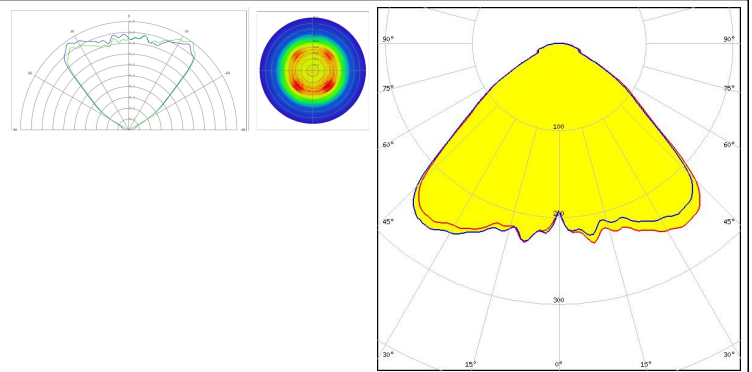
The UVC LED result tolerance is ± 10 %

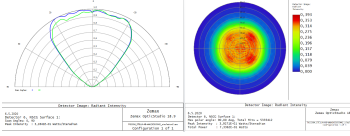
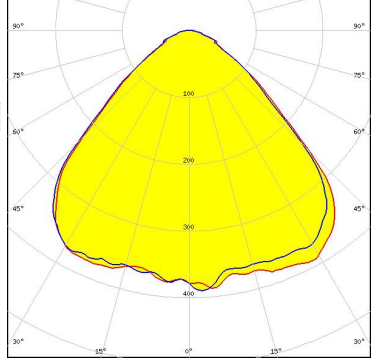
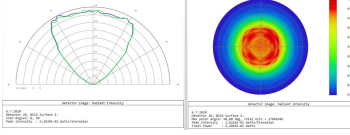
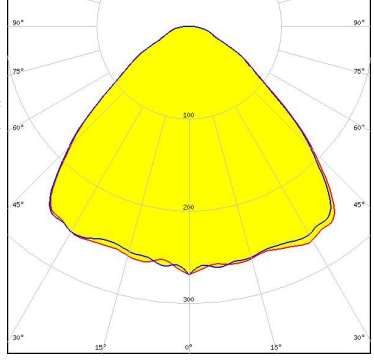
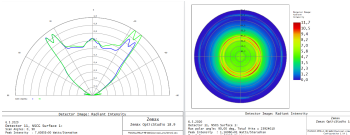
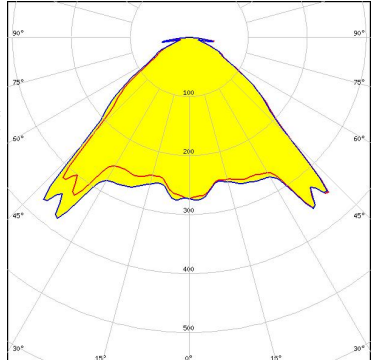

PHOTOMETRIC DATA (SIMULATED):

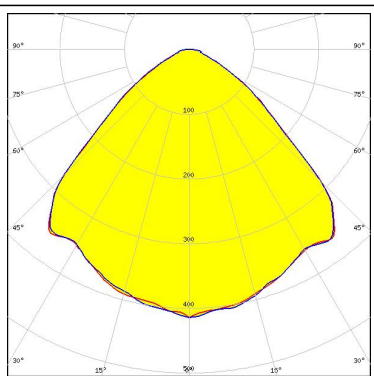
<p>NICHIA</p> <p>LED: NCSU334A FWHM / FWTM: 93.0° / 122.0° Efficiency: 73 % LEDs/each optic: 1 Light colour: UV-A Required components:</p>		
<p>SEOUL SEMICONDUCTOR</p> <p>LED: CUD8AF1D FWHM / FWTM: 100.0° / 141.0° Efficiency: 69 % LEDs/each optic: 16 Light colour: UV-C Required components:</p> <p>The UVC LED result tolerance is ± 10 %</p>		
<p>SEOUL SEMICONDUCTOR</p> <p>LED: WICOP DY9560-27 FWHM / FWTM: 92.0° / 129.0° Efficiency: 66 % LEDs/each optic: 24 Light colour: UV-C Required components:</p> <p>The UVC LED result tolerance is ± 10 %</p>		
<p>TRIDONIC</p> <p>LED: SLE G7 LES21 FWHM / FWTM: 96.0° / 132.0° Efficiency: 94 % Peak intensity: 0.4 cd/lm LEDs/each optic: 1 Light colour: White Required components:</p>		

GENERAL INFORMATION:

NOTE: The typical beam angle will be changed by different color, chip size and chip position tolerance. The typical total beam angle is the full angle measured where the luminous intensity is half of the peak value.

Due to use of high power COB's with this product, special attention to proper thermal design is highly recommended. LEDiL has no liability for direct, indirect or consecutive damages arising from the LEDiL products being used outside of the recommended temperature range.

MATERIALS:

As part of our continuous research and improvement processes, and to ensure the best possible quality and availability of our products, LEDiL reserves the right to change material grades without notice.

PRODUCT DATA USER AGREEMENT AND DISCLAIMER:

The measured data in the provided downloadable LEDiL Product Datasheets and Mechanical 2D-Drawings is rounded and provided as reference for planning. LEDiL Oy's optical specifications have been verified by conducting performance testing of the products in accordance with the company's quality system. The reported data are averaged results of multiple measurements with typical variation. LEDiL Oy reserves the right to without prior notification make changes and improvements to its products.

LEDiL Oy assumes neither warranty, nor guarantee nor any other liability of any kind for the contents and correctness of the provided data. The provided data has been generated with highest diligence but the provided data may in reality not represent the complete possible variation range of all intrinsic parameters. Therefore, in certain cases a deviation from the provided data could occur.

LEDiL Oy reserves the right to undertake technical changes of its products without further notification which could lead to changes in the provided data. LEDiL Oy assumes no liability of any kind for the possible deviation from any provided data or any other damage resulting from the usage of the provided data.

The user agrees to this disclaimer and user agreement with the download or usage of the provided files.

LEDiL Oy

Joensuunkatu 13
FI-24240 SALO
Finland

LEDiL Inc.

228 West Page Street
Suite D
Sycamore IL 60178
USA

Ledil Optics Technology (Shenzhen) Co., Ltd.

405 , Block B
Casic Motor Building
Shenzhen 518057
P.R.CHINA

Local sales and technical support

[www.ledil.com/
where_to_buy](http://www.ledil.com/where_to_buy)

Shipping locations

Salo, Finland
Hong Kong, China

Distribution Partners

[www.ledil.com/
where_to_buy](http://www.ledil.com/where_to_buy)

X-ON Electronics

Largest Supplier of Electrical and Electronic Components

Click to view similar products for [LED Lighting Lenses Assemblies](#) category:

Click to view products by [Ledil](#) manufacturer:

Other Similar products are found below :

[FCN12592_LE1-D-COP](#) [CA16129_OLGA-W](#) [CA16370_HB-SQ-W](#) [FN15972_RONDA-ZT45-C](#) [CS15759_HB-2X2MX-8-W](#)
[CA16435_LXP2-SS-WAS](#) [CN16210_GABRIELLA-MIDI-W](#) [CP17137_CARMEN-M2-C](#) [CA16015_STRADA-SQ-SCL](#) [CP17594_TINA-SC-](#)
[RS](#) [CS15767_HB-2X2MX-8-M](#) [CP10960_RGBX-SS](#) [CP12395_LXP3-W](#) [CP12939_LARISA-RS-CLIP16](#) [C14636_XTM-PF-ADAPTER](#)
[CA11819_STRADA-SQ-T-DW](#) [CA14508_G2-LXP2-D](#) [CA14601_VERONICA-SQ-MINI-RS](#) [FCP13895_SEANNA-A](#) [CP12943_LARISA-](#)
[O-CLIP16](#) [FP11124_LISA2-O-PIN](#) [CS14597_HB-IP-2X6-O](#) [CP14995_FLORENTINA-HLD-O](#) [CS15158_STRADA-IP-2X6-T4-B](#)
[CS16323_STRADELLA-IP-28-HB-M](#) [FN14976_STELLA-DWC2](#) [FN15264_STELLA-HB-WWW](#) [CA15584_ZORYA-MINI-TAPE](#)
[FA15229_ROSE-MRK-S](#) [FA15232_ROSE-MRK-M](#) [FA15233_ROSE-MRK-W](#) [FCN13552_CRYSTAL-RS](#) [FN15552_RONDA-W](#)
[FS15626_FLORENCE-3R-IP-Z90](#) [FS15786_FLORENCE-3R-IP-Z60](#) [FS15847_FLORENCE-3R-IP-O](#) [CA14505_G2-LXP2-RS2-P](#)
[FCN12775_IRIS-O](#) [CP15304_LARISA-RS-PIN](#) [FN15679_RONDA-S](#) [CA15519_VERONICA-SQ-MINI-D](#) [FP14414_LISA2-O-PIN](#)
[LL01CR-DF60L06-M2](#) [FN15993_RONDA-O](#) [FN15977_RONDA-WAS2](#) [CA14366_FLARE-MAXI-TAPE](#) [CA14442_VERONICA-SQ-W](#)
[CA14509_G2-LXP2-M-P](#) [CA15231_VERONICA-SQ-MINI-W](#) [FP11002_LISA2-W-PIN](#)