

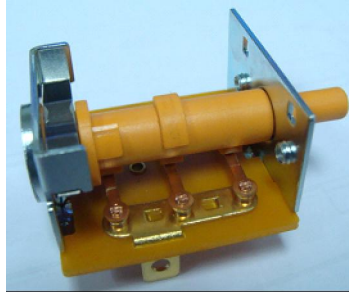

# ROTARY SWITCH

## HR31 SERIES



### SPECIFICATION

Rating:16A 125VAC (CQC)

16A 250VAC (CQC)

INITIAL CONTACT RESISTANCE:20mΩ Max

OPERATION FORCE:750~1000gf-cm

INSULATION RESISTANCE:100mΩ MIN 500VDC

WITHSTAND VOLTAGE:1000VAC FOR 1MINUTE

ENDURANCE:10,000 CYCLES

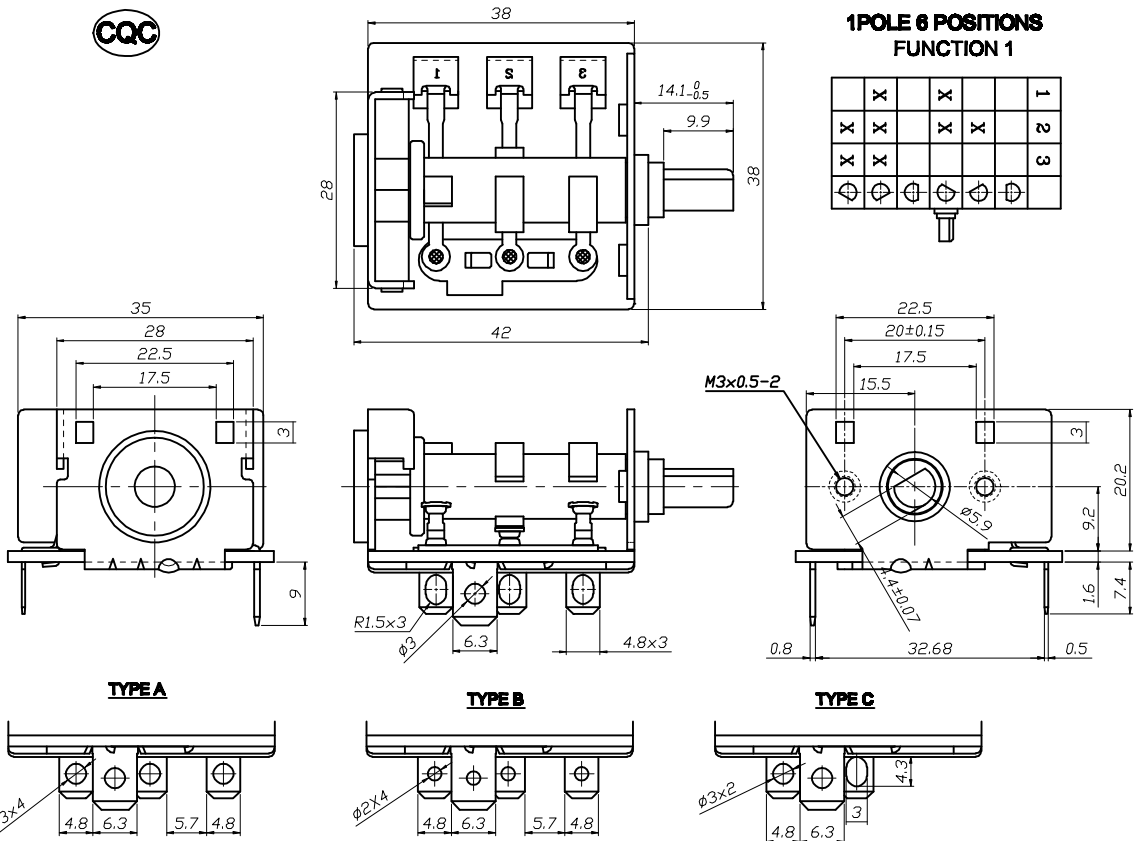

## HR31 SERIES ORDERING SYSTEM



MODEL NO.

MOUNTING TYPE	
M	SCREW TYPE M3x0.5
H	HOLE TYPE Ø3.2
S	HOLE TYPE Ø2.7

POSITION TYPE	
4	4 POSITION
5	5 POSITION
6	6 POSITION
8	8 POSITION

CONTACTS ARRANGEMENT	
1	T1/T2 SILVER T3 FORMING SHAPE
2	T1/T2 SILVER T3 BLANK
3	T1/T2/T3 SILVER
4	T1 BLANK T2/T3 SILVER
5	T1 FORMING SHAPE T2/T3 SILVER
6	T1 SILVER T2/T3 BLANK

T. HOLE TYPE	
A	SEE ATTACHED ILLUSTRATION APPENDIX A
B	
C	

FUNCTIONAL	
F1	SEE ATTACHED APPENDIX B
F2	

POLE TYPE	
1P	SINGLE POLE
2P	DOUBLE POLE

RoHS DIRECTIVE	
R	MEET RoHS DIRECTIVE
	NONE

COVER	
C	COVER
	NONE

**1 POLE/4 POSITIONS  
FUNCTION 1**

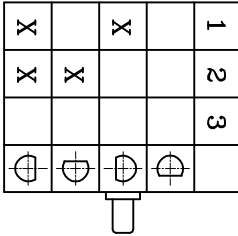

**1POLE /5 POSITIONS  
FUNCTION 1**

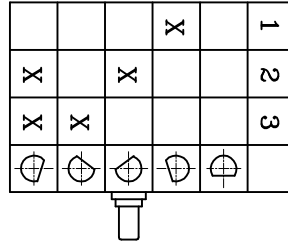

**1 POLE/6 POSITIONS  
FUNCTION 1**

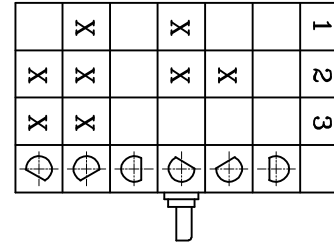

**1 POLE/8 POSITIONS  
FUNCTION 1**

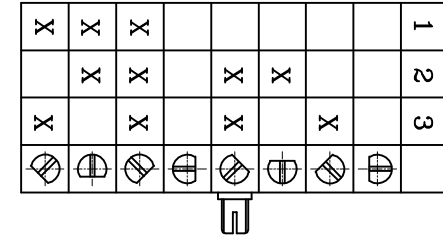

**1 POLE/4 POSITIONS  
FUNCTION 2**

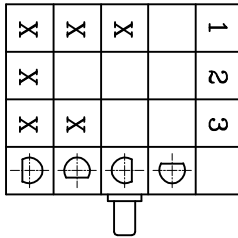

**1POLE /6 POSITIONS  
FUNCTION 2**

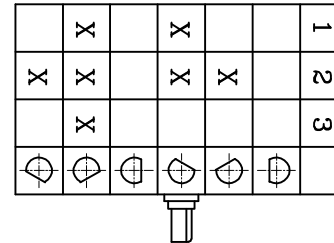

**2 POLE/4 POSITIONS  
FUNCTION 1**

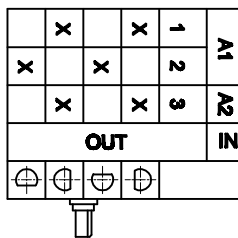

註七:A67P1L-5段1POLE  
 註六:A66P1O-4段2POLE /FUNCTION 1  
 註五:A41P1E-6段/FUNCTION 2  
 註四:A22P1E-4段/FUNCTION 2  
 註三:A10P1R-4段/FUNCTION 1  
 註二:A09P1L-6段/FUNCTION 1  
 註一:A06P1O-6段FUNCTION 1

## X-ON Electronics

Largest Supplier of Electrical and Electronic Components

*Click to view similar products for [Rotary Switches](#) category:*

*Click to view products by [Legion](#) manufacturer:*

Other Similar products are found below :

[57HS22-02-2-06N](#) [57M22-09A16N](#) [59M18-02A20N](#) [61-4970.10](#) [M3786/4-0881](#) [M3786/4-3267](#) [M3786/4-6029](#) [71ESF30-05204N](#)  
[MC06L1NCGF](#) [84986-26](#) [PLR3251](#) [PLR3262](#) [PS3](#) [A0142M2SP](#) [A019605](#) [A029303](#) [R2BB4455NNNN](#) [RMS1224](#) [DR75-AMSF-10R-B](#)  
[14-520.0360](#) [BCK1006](#) [HW1MS-0202-101](#) [A029101](#) [ACSNO-129-YB-C1014](#) [ACSNO-134-RR-YB-C1005](#) [ACSNO-353-SB-C3016](#)  
[1825537-4](#) [T505](#) [T505E](#) [H10207RR01Q](#) [M3786/39-4ZC](#) [M3786/4-0002](#) [M3786/4-0630](#) [M3786/4-1233L](#) [M3786/4-3044](#) [M3786/4-5256](#)  
[MC6CX1A502X009](#) [44MBS60-04-2-03N](#) [50KMT90-01-2-02N](#) [51A22-01-1-16S](#) [51CDP30-01PAJN](#) [51CY23771](#) [51KSP30-01D04N](#) [51P30-](#)  
[01B12N](#) [52-271.025](#) [55D30-01-2-AJN](#) [55D36-01-1-AJN](#) [55P30-01-1-12S-C](#) [55P30-01-2-04N](#) [55P36-01-1-04N](#)