



ROTARY SWITCH





MFR01 SERIES



SPECIFICATION

Rating: 8A 125VAC (CUL)
 12A-8(3)A 250V~ μT125/55(ENEC17, CB, CQC)
 INITIAL CONTACT RESISTANCE: 20mΩ Max
 OPERATION FORCE: 600±300gf-cm
 INSULATION RESISTANCE: 100mΩ MIN 500VDC
 WITHSTAND VOLTAGE: 1000VAC FOR 1MINUTE
 ENDURANCE: 10,000CYCLES



POSITION OPTION		TERMINAL TYPE
00	1 POSITIONS	S 
01	2 POSITIONS	
02	3 POSITIONS	P 
03	4 POSITIONS	
04	5 POSITIONS	
05	6 POSITIONS	T 
06	7 POSITIONS	
07	8 POSITIONS	L 
*08	9 POSITIONS	
*10	10 POSITIONS	
C1	5 POSITIONS	
C2	3 POSITIONS	
C3	5 POSITIONS	
92	4 POSITIONS	

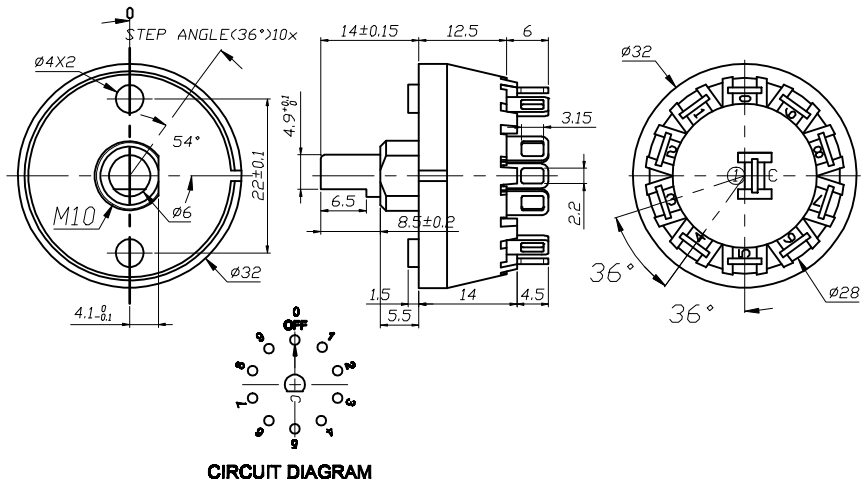

Terminal list

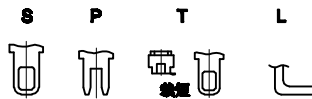

PANEL CUTOUT

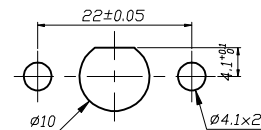

MFR01 SERIES ORDERING SYSTEM





MFR01 - A 1 F 0 5 L 1 A S N - R

MODEL NO.





STEP ANGLE	
A1	36°
A2	45°

FUNCTION TYPE	
F	NORMAL
M	MOMENTARY (NON-LOCK)

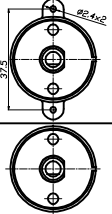
POSITION OPTION	
00	1 POSITIONS
01	2 POSITIONS
02	3 POSITIONS
03	4 POSITIONS
04	5 POSITIONS
05	6 POSITIONS
06	7 POSITIONS
07	8 POSITIONS
*08	9 POSITIONS
*10	10 POSITIONS
C1	5 POSITIONS
C2	3 POSITIONS
C3	5 POSITIONS
92	4 POSITIONS

SHAFT OPTIONS	
L1	
L2	
L3	
L4	

HOUSING TYPE	
A	

TERMINAL TYPE	
S	
P	
T	
L	

ACCESSORIES	
N	No Hex Nut
	With Hex Nut (Unmounted)

RoHS COMPLIANCE	
R	RoHS COMPLIANCE
	NONE

* 1. STEP ANGLE A1: POSITION 08, 10 ARE NOT AVAILABLE FOR MOMENTARY FUNCTION TYPE
 2. STEP ANGLE A2: POSITION 06, 07, 08, 10, C1, C2 ARE NOT AVAILABLE FOR MOMENTARY FUNCTION TYPE

X-ON Electronics

Largest Supplier of Electrical and Electronic Components

Click to view similar products for [Rotary Switches](#) category:

Click to view products by [Legion](#) manufacturer:

Other Similar products are found below :

[57HS22-02-2-06N](#) [57M22-09A16N](#) [59M18-02A20N](#) [61-4970.10](#) [M3786/4-0881](#) [M3786/4-3267](#) [M3786/4-6029](#) [71ESF30-05204N](#)
[MC06L1NCGF](#) [84986-26](#) [PLR3251](#) [PLR3262](#) [PS3](#) [A0142M2SP](#) [A019605](#) [A029303](#) [R2BB4455NNNN](#) [RMS1224](#) [DR75-AMSF-10R-B](#)
[14-520.0360](#) [BCK1006](#) [HW1MS-0202-101](#) [A029101](#) [ACSNO-129-YB-C1014](#) [ACSNO-134-RR-YB-C1005](#) [ACSNO-353-SB-C3016](#)
[1825537-4](#) [T505](#) [T505E](#) [H10207RR01Q](#) [M3786/39-4ZC](#) [M3786/4-0002](#) [M3786/4-0630](#) [M3786/4-1233L](#) [M3786/4-3044](#) [M3786/4-5256](#)
[MC6CX1A502X009](#) [44MBS60-04-2-03N](#) [50KMT90-01-2-02N](#) [51A22-01-1-16S](#) [51CDP30-01PAJN](#) [51CY23771](#) [51KSP30-01D04N](#) [51P30-](#)
[01B12N](#) [52-271.025](#) [55D30-01-2-AJN](#) [55D36-01-1-AJN](#) [55P30-01-1-12S-C](#) [55P30-01-2-04N](#) [55P36-01-1-04N](#)