

- 1.CIRCUIT: ON/OFF
- 2." \varnothing "DENOTES CRITICAL DIMENSIONS.
- 3.Operation force : $800\pm 300gf$
- 4.RATING:16A GP 125/250VAC 3/4HP 125/250VAC T125(CUL)
 16(4)A 125/250V~ T125/55(ENEC17;NEMKO;CB)
 6(4)A 250~ T125/55(CQC)
 C-UL APPROVAL FILE NO.E153399
 ENEC17 CERTIFICATE NO.3689
 NEMKO CERTIFICATE NO.P10213218/A2
 CQC CERTIFICATE NO.CQC10002051908
 CB APPROVAL FILE NO.60225/A1/M1

- 5.Contact resistance : $< 30m\Omega$
- 6.Insulation resistance : $> 100M\Omega(500VDC$ between open contacts)
- 7.Dielectric strength : $> 1500Vac$ 0.5mA 1 mintue
- 8.ACTUATOR COLOR:WHITE
 HOUSING COLOR:WHITE
 BASE COLOR:BLACK
- 9.ALL MATERIALS ARE ROHS COMPLIANT

TEL: 0769-82310511-867

PANEL CUTOUT DIMENSION:

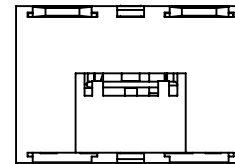
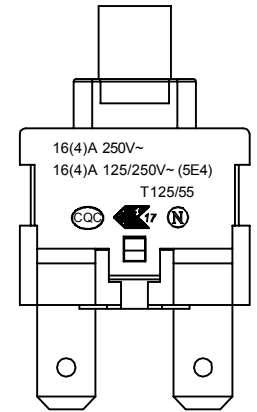
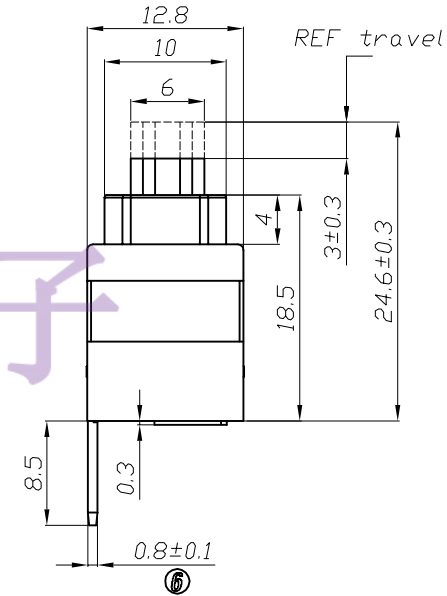
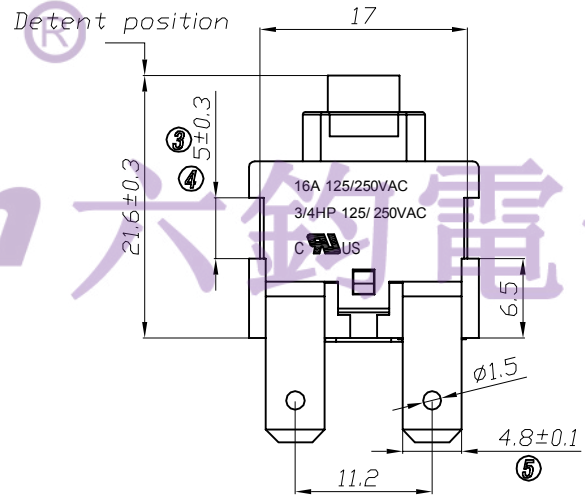
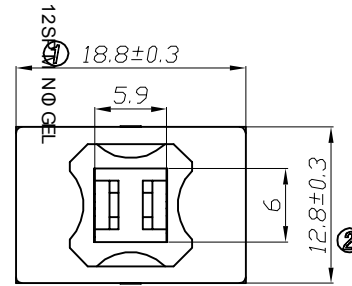
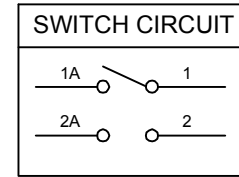
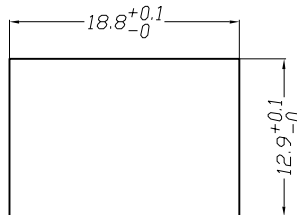

修正 REVISION	說明 DESCRIPTION	修訂者 REVISED BY	SPECIFICATION				公差 TOLERANCES		TOLERANCES UNLESS OTHERWISE SPEC.±0.5/0.02,ANG.±3		
			製圖 DRAWN BY	設計 DESIGNED BY	校對 CHECKED BY	核准 APPROVED BY	單位 UNIT	mm	機種名稱 MODEL NAME	PUSH SW	機種編號 MODEL NO.
△							比例 SCALE	5/3	六鈞電子五金有限公司 LEGION ELECTRONIC & HARDWARE CO., LTD.		
△			04-Mar-2013	04-Mar-2013	04-Mar-2013	04-Mar-2013	日期 DATE	2013.03.04			
△			唐彪	唐彪	唐彪	吉慶玉					

X-ON Electronics

Largest Supplier of Electrical and Electronic Components

Click to view similar products for [Pushbutton Switches](#) category:

Click to view products by [Legion](#) manufacturer:

Other Similar products are found below :

[8971K1133](#) [LW2L-M1C20M-A](#) [01-153.025](#) [M22-D-R-GB0/K11](#) [67021K512](#) [701PB580](#) [7199K101](#) [810K12910](#) [810KSV30B](#) [FLT 2U EE](#)
[01A](#) [MML21EA2ADK](#) [MML21KA3ABK](#) [MML23KW3AA01W](#) [8418K2](#) [8442K3](#) [8450K1](#) [860K11911T01A](#) [861901](#) [861K11911T01A07](#)
[861K13810T00A14](#) [861K13911](#) [8646AB6X718UL](#) [9533CD4+U574+U4922](#) [99-450.837](#) [99-453.837](#) [A2PMA1X03EC56](#) [A3A-7310](#) [A3A-](#)
[7340](#) [12037A2ULCSA](#) [1203A2UL](#) [ABGW410-R](#) [1211390004](#) [ABN400-R](#) [121382](#) [1213C3](#) [HE3B-M2](#) [1211500044](#) [121194](#) [1212MRA](#)
[1232A6NF](#) [121489](#) [1223A2ULCSA](#) [D5P-MT4](#) [13435AG](#) [13445AD29GX768](#) [AG23-L2](#) [AH165-2SGLG1TE3](#) [AH165-TGFY22](#) [AH165-](#)
[TGL5Y11E3](#) [AH165-TGLR11AA3](#)