

HAOYU

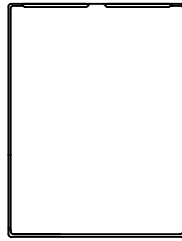

TOP VIEW

MECHANICAL:

DURABILITY : 750 CYCLES MIN.
 MATING FORCE : 23N MAX.
 OPERATING TEMPERATURE: -40°C~+85°C.
 STORAGE TEMPERATURE: -40°C~+85°C.
 ALL CRITICAL DIMENSIONS WITH "±"

Electrical:

- Turn ratio: 1~2:J1~J2=1CT:1CT(±2%).
3~6:J3~J6=1CT:1CT(±2%).
- OCL:350uH Min.at 100KHz 100mV 8mA DC.
- Insertion Loss: -1.0 dB Max 1~100MHz.
- Return loss: -20dB Min 1~10MHz;
-16dB Min 10~30MHz.
-12dB Min 30~60MHz.
-10dB Min 60~80MHz.
- Cross talk: -40dB Min 1~30MHz;
-35dB Min 30~60MHz;
-30dB Min 60~100MHz;
- CMR: -30dB Min 1~100MHz;
- Hi-Pot:1500V AC & 2250V DC
6S 1mA PRI TO SEC

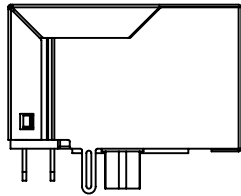

LEFT SIDE VIEW

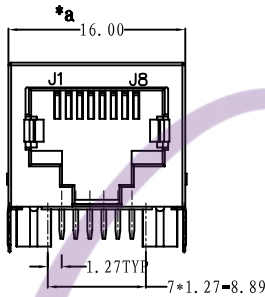

FRONT VIEW

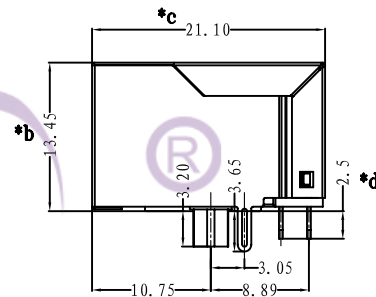

RIGHT SIDE VIEW

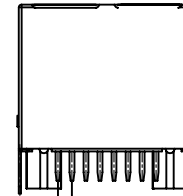

BACK VIEW

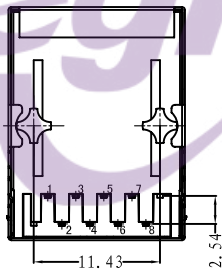

BOTTOM VIEW

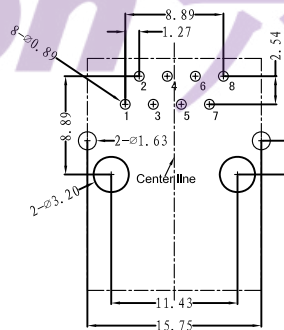

RECOMMENDED PCB LAYOUT
VIEWED FROM COMPONENT SIDE

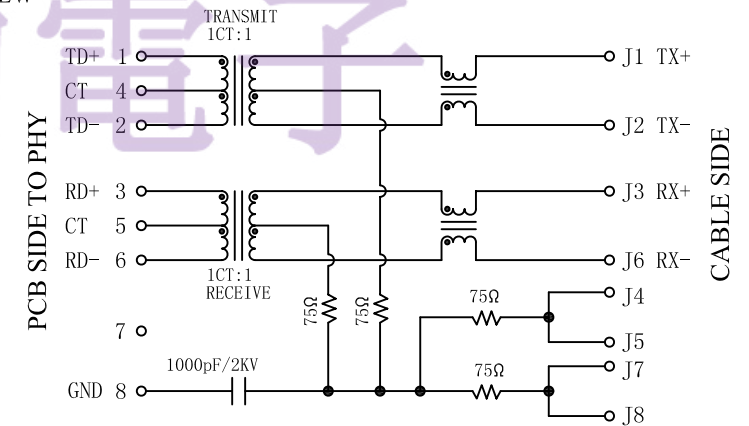

				TOLERANCE UNLESS SPECIFIED								
				UP TO 5mm: ±0.1	ANGULAR	A0	2022.7.18	初次发行	WM			
				ABOVE 5mm: ±0.2	±1°	NO	DATE	REVISIONS	BY	APPD		
4	TERMINAL	PHOSPHOR BRONZE	8	6U" Au-PLATED (CONTACT AREA)			TITLE: PCB JACK	UNIT : MM	ROHS COMPLIANT	DWN		
3	SHIELD	BRASS	1	Ni-PLATED			MODEL: PCB-832E	SCALE: 1:1		CHK'D		
2	TERMINALS BRACKET	PA9T(UL94V-0)	1	BLACK								
1	HOUSING	PA9T(UL94V-0)	1	BLACK								
NO.	PART NAME	MATERIAL	QTY	FINISHING			东莞市六钧电子五金有限公司 PRO.AGL: REV :A0					

X-ON Electronics

Largest Supplier of Electrical and Electronic Components

Click to view similar products for [Modular Connectors](#) / [Ethernet Connectors](#) category:

Click to view products by [Legion](#) manufacturer:

Other Similar products are found below :

[8949-H88/06BLKA/SN](#) [74441-0010/BKN](#) [PHP-6P6C-5](#) [GAX-3-66](#) [GDCX-PN-66](#) [GLX-A-44](#) [GLX-N-1010M-BLK](#) [GLX-S-88M-BLK](#)
[GMX-SMT4-N-88](#) [GSGX-N-2-88](#) [GSGX-N-4-88](#) [GSX-NS2-88-3.05](#) [GSX-NS-88-3.68](#) [PT-108A-8C-UL](#) [PTS-J531-8CS-50UL](#) [A-2014-0-4](#)
[GWLX-S9-88-YG](#) [DC-1021-8-WH-6](#) [1300530003](#) [1324640-4](#) [132764-001](#) [1413235](#) [MPS88RX-5000](#) [E5288-S000K3-L](#) [155302-001](#)
[AX101050](#) [AX101063](#) [AX101065](#) [AX101072](#) [AX101307](#) [AX101315](#) [AX101318](#) [AX102271](#) [AX102277](#) [AX102651](#) [AX102660](#) [AX104024](#)
[203475](#) [PC4D0018P](#) [PC4D0024-19NX-1-B](#) [KIT38082NI](#) [8949-B88/6](#) [2-6609208-5](#) [30-8956](#) [30-8964-100](#) [SM85](#) [SM99S01VBNN04G7](#) [17-](#)
[103540](#) [191587](#) [PDI-68-RV](#)