

NOTES:

1.Circuit:ON/OFF Tungsten Lamp

2.Operation force: 500±200gf

3.Electrical rating:10A 125/250VAC
6A 250VAC
10(4)A 250VAC

4.Contact resistance:<30mΩ (intital)

5.Insulation resistance:>1000MΩ(500VDC)
between open contacts)

6.Dielectric strength:>1500VAC 1 minute

7.Color: cover is red, body is black.

Panel cut - out:

X	Dim.Y	Dim.Z
0.75~1.25mm	19.20+0.1/-0	12.80+0.1/-0
1.25~2.0mm	19.30+0.1/-0	12.80+0.1/-0

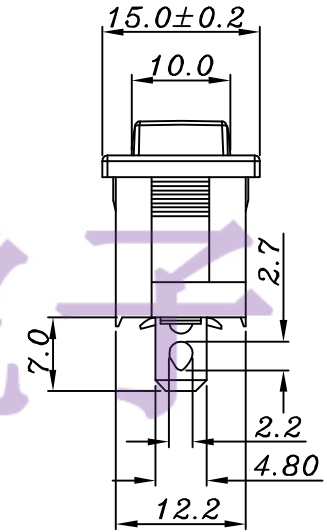
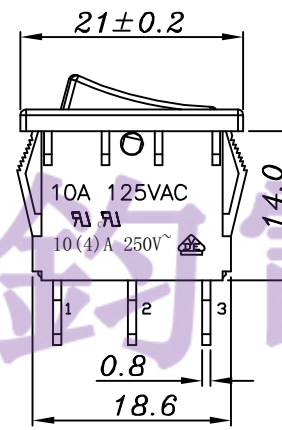
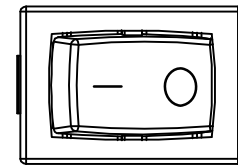
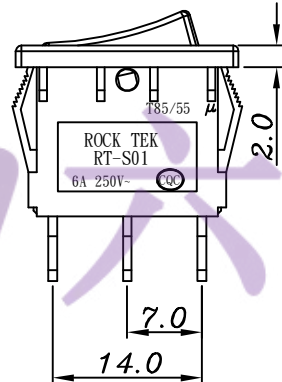
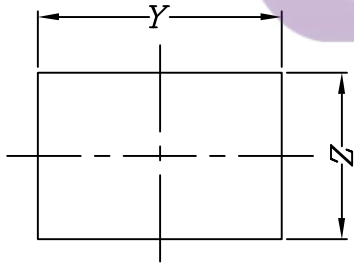

Circuit of Switch

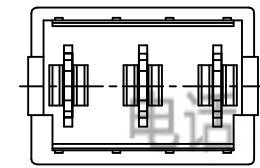
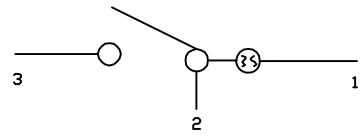

電話: 0769-82310511-867
邮箱: hooya89@hooya.hk
V: hooya89

NO	DESCRIPTION	NO	DESCRIPTION	ANGLES	TOLERANCE	APPROVED	CHECKED	DESIGN	DRAWN	ALL SIZE ARE IN	MM	DRAWING NO. REV	
5	→	10	→		DIMENSIONAL TOLERANCES					SCALE	FIT	WIF110012	A
4	→	9	→		RANGE TOLERANCE					MAT'L	***		
3	→	8	→	X	±0.4				LJQ	MATERIAL NO.			
2	→	7	→	X.X	±0.3					RT-S01-113-L4LBR			
1	→	6	→	X.XX	±0.2								
				±0.5°		LEGION ELECTRONIC & HARDWARE CO., LTD							

1.Scope

This specification covers the RT-S01 series rocker switch.

2.Rating

10A 125VAC UL,CUL

10(4)A 250VAC VDE

6A 250VAC CQC

3.Standard

UL1054, EN60158-1 2002, GB15092

4.Dimensions

Dimensions of this switch are shown on the following drawing.

5.Electrical

5.1. Contact Resistance

The contact resistance should be 50m Ω (Max).

5.2. Insulation resistance

It is measured with 500V DC 1 minute should be 100M Ω (Min).

5.3.Dielectric strength

(Between terminals of open contacts and terminals of opposite polarity)

Dielectric strength should withstand without breakdown a potential of AC
1500V/minute.

(Between terminals and metal frame)

Dielectric strength should withstand without breakdown a potential of AC
1500V/minute

6.Terminal Strength

Using a static force of 5kg in one direction on the tip terminal for 1 minute.

电话 : 0769-82310

邮箱 : hooya89@h

V : hooya89

ROCK TEK ELECTRONICS(SHENZHEN)CO., LTD.

富 力 隆 電 子 (深 圳) 有 限 公 司

Specification Of RT-S01 Series Rocker Switch page:2/2

The terminal may be deformed, but should not sustain any trouble as deviation
And breaking of terminal and breaking of insulation.

7.Life test

All of the electrical life all over 10,000 cycles.

8.Soldering test

The terminals shall be well soldered of dipped place of immersed place in the solder.
Dipped in molten solder of $260^{\circ}\pm 5^{\circ}\text{C}$ and the dwell time in solder is 3~5 seconds and
More than 75% of the dipped shall be covered by solder.

9. Humidity test

The switch shall be stored at a temperature of $40\pm 2^{\circ}\text{C}$ and a humidity of 90% to 95%
for 96 hours. Then the switch shall be maintained at standard atmospheric condition
for 1 hour after which measurement shall be made. The shall be no deformation or cracks
in molded part.

电话 : 0769-82310

邮箱 : hooya89@h

V : hooya89



WOYR2.E300970 Switches, Appliance and Special Use - Component

For enhanced search functionality, please visit UL's [iQ™ Family of Databases](#).
Click on a product designation for complete information.

[Page Bottom](#)

Switches, Appliance and Special Use - Component

[See General Information for Switches, Appliance and Special Use - Component](#)

ROCK TEK ELECTRONICS INDUSTRY CORP

E300970

98 GUANGUANG RD
BAO'AN DISTRICT, GUANLAN TOWN
SHENZHEN, GUANGDONG 518110 CHINA

Investigated to ANSI/UL 1054

Cat. No.	Amps	Volts	Hz	Load	Endurance	Temp C	POL/THR	Per Pole/Circuit Code	SPCOA
M1	7.5	125	60	GP	6K	75	1/2	-/A	-
	5	250	60	GP	6K				
RT-M2,f/b 0, 1, 2, 3, 4, 5 or 6									
	5	125	60	GP	6K	85	1/2	-/A	-
	5	250	60	GP	6K				
	6	30	DC	R	6K				
RT-P02	7	14	DC	-	6K	65	1/2	-/A	-
RT-P03	16	125	60	GP	6K	85	1/1	-/A	Note 2
	16	250	60	GP	6K				
	-	125	60	3/4hp	6K				
RT-P04	16	125	60	GP	6K	95	1/1	-/A	-
	-	125	60	1/2hp	6K				
RT-P05	14	125	50/60	GP	6K	65	2/1	-/B	Note 11A
	14	250	50/60	GP	6K				
	-	125	50/60	1/2hp	6K				
	-	250	50/60	1hp	6K				
RT-S01	10	125	60	GP	6K	85	1/1	-/A	
	6	250	60	GP	6K				
RT-S01A	10	125	60	GP	6K	85	1/1	-/A	Note 2
	6	250	60	GP	6K				
RT-S02	15	125	60	GP	6K	85	1/1	-/A	-
	8	250	60	GP	6K				
RT-S02A	15	125	60	GP	6K	85	1/1	-/A	Note 2
	8	250	60	GP	6K				
RT-S03	16	125	60	GP	6K	105	2/1	-/B	-
	16	250	60	GP	6K				
	-	125	60	1/3hp	6K				
RT-S03A	16	125	60	GP	6K	105	2/1	-/B	Note 2
	16	250	60	GP	6K				

电话：0769-82310

邮箱：hooya89@h

V：hooya89

	-	125	60	1/3hp	6K				
RT-S05	15	125	60	GP	6K	125	2/2	-/B	-
RT-S06 f/b A or Blank	16	125	60	GP	6K	85	1/1	-/A	Note 2
	10	250	60	GP	6K				
	-	125	60	3/4hp	6K				
	-	250	60	1hp	6K				

Note 11A - Switch may be marked with the voltage rating single or double underlined for tested using 240 V or 250 V to ground.

Note 2 - These are lighted switches employing a lamp. The usable lamp life has not been evaluated.

Marking: Company name, catalog, model or part number, electrical ratings and the Recognized Component Mark,  on the product or on the smallest unit container in which the product is packaged.

Last Updated on 2016-07-19

[Questions?](#)

[Print this page](#)

[Terms of Use](#)

[Page Top](#)

◆ 2016 UL LLC

The appearance of a company's name or product in this database does not in itself assure that products so identified have been manufactured under UL's Follow-Up Service. Only those products bearing the UL Mark should be considered to be Certified and covered under UL's Follow-Up Service. Always look for the Mark on the product.

UL permits the reproduction of the material contained in the Online Certification Directory subject to the following conditions: 1. The Guide Information, Assemblies, Constructions, Designs, Systems, and/or Certifications (files) must be presented in their entirety and in a non-misleading manner, without any manipulation of the data (or drawings). 2. The statement "Reprinted from the Online Certifications Directory with permission from UL" must appear adjacent to the extracted material. In addition, the reprinted material must include a copyright notice in the following format: "© 2016 UL LLC".



电话 : 0769-82310

邮箱 : hooya89@h

V : hooya89

**WOYR8.E300970****Switches, Appliance and Special Use Certified for Canada - Component**For enhanced search functionality, please visit UL's [iQ™ Family of Databases](#).

Click on a product designation for complete information.

[Page Bottom](#)**Switches, Appliance and Special Use Certified for Canada - Component**[See General Information for Switches, Appliance and Special Use Certified for Canada - Component](#)**ROCK TEK ELECTRONICS INDUSTRY CORP**

E300970

98 GUANGUANG RD

BAO'AN DISTRICT, GUANLAN TOWN

SHENZHEN, GUANGDONG 518110 CHINA

Investigated to CSA-C22.2 No. 55

Cat. No.	Amps	Volts	Hz	Load	Endurance	Temp C	POL/THR	Per Pole/Circuit Code	SPCOA
M1	7.5	125	60	GP	6K	75	1/2	-/A	-
	5	250	60	GP	6K				
RT-M2,f/b 0, 1, 2, 3, 4, 5 or 6									
	5	125	60	GP	6K	85	1/2	-/A	-
	5	250	60	GP	6K				
	6	30	DC	R	6K				
RT-P02	7	14	DC	-	6K	65	1/2	-/A	-
RT-P03	16	125	60	GP	6K	85	1/1	-/A	Note 2
	16	250	60	GP	6K				
	-	125	60	3/4hp	6K				
RT-P04	16	125	60	GP	6K	95	1/1	-/A	-
	-	125	60	1/2hp	6K				
RT-P05	14	125	50/60	GP	6K	65	2/1	-/B	Note 11A
	14	250	50/60	GP	6K				
	-	125	50/60	1/2hp	6K				
	-	250	50/60	1hp	6K				
RT-S01	10	125	60	GP	6K	85	1/1	-/A	
	6	250	60	GP	6K				
RT-S01A	10	125	60	GP	6K	85	1/1	-/A	Note 2
	6	250	60	GP	6K				
RT-S02	15	125	60	GP	6K	85	1/1	-/A	-
	8	250	60	GP	6K				
RT-S02A	15	125	60	GP	6K	85	1/1	-/A	Note 2
	8	250	60	GP	6K				
RT-S03	16	125	60	GP	6K	105	2/1	-/B	-
	16	250	60	GP	6K				
	-	125	60	1/3hp	6K				
RT-S03A	16	125	60	GP	6K	105	2/1	-/B	Note 2
	16	250	60	GP	6K				

电话：0769-82310

邮箱：hooya89@h

V：hooya89

	-	125	60	1/3hp	6K				
RT-S05	15	125	60	GP	6K	125	2/2	-/B	-
RT-S06 f/b A or Blank	16	125	60	GP	6K	85	1/1	-/A	Note 2
	10	250	60	GP	6K				
	-	125	60	3/4hp	6K				
	-	250	60	1hp	6K				

Note 11A - Switch may be marked with the voltage rating single or double underlined for tested using 240 V or 250 V to ground.

Note 2 - These are lighted switches employing a lamp. The usable lamp life has not been evaluated.

Marking: Company name, catalog, model or part number, electrical ratings and the Recognized Component Mark for Canada,  on the product or on the smallest unit container in which the product is packaged.

Last Updated on 2016-07-19

[Questions?](#)

[Print this page](#)

[Terms of Use](#)

[Page Top](#)

◆ 2016 UL LLC

The appearance of a company's name or product in this database does not in itself assure that products so identified have been manufactured under UL's Follow-Up Service. Only those products bearing the UL Mark should be considered to be Certified and covered under UL's Follow-Up Service. Always look for the Mark on the product.

UL permits the reproduction of the material contained in the Online Certification Directory subject to the following conditions: 1. The Guide Information, Assemblies, Constructions, Designs, Systems, and/or Certifications (files) must be presented in their entirety and in a non-misleading manner, without any manipulation of the data (or drawings). 2. The statement "Reprinted from the Online Certifications Directory with permission from UL" must appear adjacent to the extracted material. In addition, the reprinted material must include a copyright notice in the following format: "© 2016 UL LLC".

legion 六鈞電子

电话：0769-82310

邮箱：hooya89@h

V：hooya89

ZEICHENGENEHMIGUNG MARKS APPROVAL

Rock Tek Electronics
(Shenzhen) Co., Ltd.
No. 98 Guanguang Road
Guanlan Town
518110 BAOAN DISTRICT, SHENZHEN CITY
CHINA

ist berechtigt, für ihr Produkt /
is authorized to use for their product

Geräteschalter
Switch for appliances

die hier abgebildeten markenrechtlich geschützten Zeichen
für die ab Blatt 2 aufgeführten Typen zu benutzen /
the legally protected Marks as shown below for the types referred to on page 2 ff.

legion 大鈞電子



Geprüft und zertifiziert nach /
Tested and certified according to

DIN EN 61058-1 (VDE 0630-1):2008-09; EN 61058-1:2002 + A2:2008
IEC 61058-1:2000
IEC 61058-1:2000/AMD1:2001
IEC 61058-1:2000/AMD2:2007

电话 : 0769-82310
邮箱 : hooya89@h
V : hooya89



VDE Prüf- und Zertifizierungsinstitut GmbH
VDE Testing and Certification Institute
Zertifizierungsstelle / Certification

M. Tasotti

Aktenzeichen: 5004990-4401-0002 / 233125

File ref.:

Ausweis-Nr. 40018133

Blatt 1

Certificate No.

Page

Weitere Bedingungen siehe Rückseite und Folgeblätter /
further conditions see overleaf and following pages

Offenbach, 2006-06-29

(letzte Änderung / updated 2017-03-30)

M. Tasotti
VDE Zertifikate sind nur gültig bei Veröffentlichung unter:
VDE certificates are valid only when published on:

<http://www.vde.com/zertifikat>
<http://www.vde.com/certificate>

Name und Sitz des Genehmigungs-Inhabers / Name and registered seat of the Certificate holder

Rock Tek Electronics (Shenzhen) Co., Ltd., No. 98 Guanguang Road, Guanlan Town, 518110 BAOAN
DISTRICT, SHENZHEN CITY, Guangdong, CHINA

Aktenzeichen / File ref.

5004990-4401-0002 / 233125 / CC1 / LF

letzte Änderung / updated

2017-03-30

Datum / Date

2006-06-29

Dieses Blatt gilt nur in Verbindung mit Blatt 1 des Zeichengenehmigungsausweises Nr. 40018133.

This supplement is only valid in conjunction with page 1 of the Certificate No. 40018133.

Geräteschalter Switch for appliances

Typ(en) / Type(s)

RT-S01

Bemessungsspannung, AC
Rated voltage, AC 250 V

Bemessungsstrom
Rated current 10(4) A

Art und Anschluss von Schaltern
Type and connection of switches Wippenschalter ; Kode 1.2
Rocker switch ; code 1.2

Abschaltung
Disconnection Mikro Abschaltung
micro disconnection

Schaltzyklen
Number of operating cycles 10E3

Umgebungs-Lufttemperatur
Ambient air temperature T85/55

Art der Montage
Method of mounting zum Einbau in Geräte der Schutzklasse I und II
Incorporated in class I and class II equipment

Art der Betätigung
Method of actuating direkte Betätigung
direct actuating

Schalter der Kategorie
Switch category 3

Glühdrahtprüfung (GWT)
Glow-wire test (GWT) 850°C

Fortsetzung siehe Blatt 3 /
continued on page 3

Name und Sitz des Genehmigungs-Inhabers / Name and registered seat of the Certificate holder

Rock Tek Electronics (Shenzhen) Co., Ltd., No. 98 Guangguang Road, Guanlan Town, 518110 BAOAN DISTRICT, SHENZHEN CITY, Guangdong, CHINA

Aktenzeichen / File ref.

5004990-4401-0002 / 233125 / CC1 / LF

letzte Änderung / updated

2017-03-30

Datum / Date

2006-06-29

Dieses Blatt gilt nur in Verbindung mit Blatt 1 des Zeichengenehmigungsausweises Nr. 40018133.

This supplement is only valid in conjunction with page 1 of the Certificate No. 40018133.

Kriechstromfestigkeit
Tracking resistance

PTI 250

Anschluss
Type of terminal

Lötanschluss
Solder terminal

Überspannungskategorie
Overvoltage category

II



Verschmutzungsgrad
Degree of pollution

2

Werkstoffgruppe
Material group

IIIa

Weitere Angaben siehe Anlage
Further information see appendix

Nr. 1 vom 2017-03-30
No. 1 dated 2017-03-30

Anmerkung

Luft- und Kriechstrecken zwischen unter Spannung stehenden
Teilen und dem Betätiger: Verstärkte Isolierung

Remark

Clearance and creepage distances between live parts and the
actuating mean: Reinforced insulation

Dieser Zeichengenehmigungs-Ausweis bildet eine Grundlage für die EG-Konformitätserklärung und CE-Kennzeichnung durch den Hersteller oder dessen Bevollmächtigten und bescheinigt die Konformität mit den grundlegenden Schutzanforderungen der **EG-Niederspannungsrichtlinie 2014/35/EU**.

*This Marks Approval is a basis for the EC Declaration of Conformity and the CE Marking by the manufacturer or his agent and proves the conformity with the essential safety requirements of the **EC Low-Voltage Directive 2014/35/EU**.*

VDE Prüf- und Zertifizierungsinstitut GmbH
VDE Testing and Certification Institute
Fachgebiet CC1
Section CC1

电话: 0755 82310
邮箱: hooya89@h
V: hooya89

VDE Prüf- und Zertifizierungsinstitut Zeichengenehmigung

Ausweis-Nr. / Beiblatt /
Certificate No. Supplement
40018133

Name und Sitz des Genehmigungs-Inhabers / Name and registered seat of the Certificate holder

Rock Tek Electronics (Shenzhen) Co., Ltd., No. 98 Guanguang Road, Guanlan Town, 518110 BAOAN
DISTRICT, SHENZHEN CITY, Guangdong, CHINA

Aktenzeichen / File ref.

5004990-4401-0002 / 233125 / CC1 / LF

letzte Änderung / updated

2017-03-30

Datum / Date

2006-06-29

Dieses Beiblatt ist Bestandteil des Zeichengenehmigungsausweises Nr. 40018133.

This supplement is part of the Certificate No. 40018133.

Geräteschalter Switch for appliances

Fertigungsstätte(n) Place(s) of manufacture

Referenz/Reference
30024144

Dongguan Legion Electronic & Hardware
Co., Limited
TongDe Xi Rd., Sicun, Shijie Town
523304 DONGGUAN
Guangdong
CHINA



VDE Prüf- und Zertifizierungsinstitut GmbH
VDE Testing and Certification Institute
Fachgebiet CC1
Section CC1

电话 : 0769-82310
邮箱 : hooya89@h
V : hooya89



VDE Prüf- und Zertifizierungsinstitut Zeichengenehmigung

Ausweis-Nr. / Infoblatt /
Certificate No. / Info sheet
40018133

Name und Sitz des Genehmigungs-Inhabers / Name and registered seat of the Certificate holder

Rock Tek Electronics (Shenzhen) Co., Ltd., No. 98 Guangguang Road, Guanlan Town, 518110 BAOAN
DISTRICT, SHENZHEN CITY, Guangdong, CHINA

Aktenzeichen / File ref.

5004990-4401-0002 / 233125 / CC1 / LF

letzte Änderung / updated

2017-03-30

Datum / Date

2006-06-29

Dieses Blatt gilt nur in Verbindung mit Blatt 1 des Zeichengenehmigungsausweises Nr. 40018133.

This supplement is only valid in conjunction with page 1 of the Certificate No. 40018133.

Genehmigung zum Benutzen des auf Seite 1 abgebildeten markenrechtlich geschützten Zeichens des VDE:

Grundlage für die Benutzung sind die Allgemeinen Geschäftsbedingungen (AGB) der VDE Prüf- und Zertifizierungsinstitut GmbH (www.vde.com\AGB-Institut). Das Recht zur Benutzung erstreckt sich nur auf die bezeichnete Firma mit den genannten Fertigungsstätten und die oben aufgeführten Produkte mit den zugeordneten Bezeichnungen. Die Fertigungsstätte muss so eingerichtet sein, dass eine gleichmäßige Herstellung der geprüften und zertifizierten Ausführung gewährleistet ist.

Die Genehmigung ist so lange gültig wie die VDE-Bestimmungen gelten, die der Zertifizierung zugrunde gelegen haben, sofern sie nicht auf Grund anderer Bedingungen aus der VDE Prüf- und Zertifizierungsordnung (PM102) zurückgezogen werden muss.

Der Gültigkeitszeitraum einer VDE-GS-Zeichengenehmigung kann auf Antrag verlängert werden. Bei gesetzlichen und / oder normativen Änderungen kann die VDE-GS-Zeichengenehmigung ihre Gültigkeit zu einem früheren als dem angegebenen Datum verlieren.

Produkte, die das Biozid Dimethylfumarat (DMF) enthalten, dürfen gemäß der Kommissionsentscheidung 2009/251/EG nicht mehr in den Verkehr gebracht oder auf dem Markt bereitgestellt werden.

Der VDE-Zeichengenehmigungsausweis wird ausschließlich auf der ersten Seite unterzeichnet.

Approval to use the legally protected Mark of the VDE as shown on the first page:

Basis for the use are the general terms and conditions of the VDE Testing and Certification Institute (www.vde.com\terms-institute). The right to use the mark is granted only to the mentioned company with the named places of manufacture and the listed products with the related type references. The place of manufacture shall be equipped in a way that a constant manufacturing of the certified construction is assured.

The approval is valid as long as the VDE specifications are in force, on which the certification is based on, unless it is withdrawn according to the VDE Testing and Certification Procedure (PM102E).

The validity period of a VDE-GS-Mark Approval may be prolonged on request. In case of changes in legal and / or normative requirements, the validity period of a VDE-GS-Mark Approval may be shortened.

Products containing the biocide dimethylfumarate (DMF) may not be marketed or made available on the EC market according to the Commission Decision 2009/251/EC.

The approval is solely signed on the first page.

X-ON Electronics

Largest Supplier of Electrical and Electronic Components

Click to view similar products for [Rocker Switches](#) category:

Click to view products by [Legion](#) manufacturer:

Other Similar products are found below :

[LTILA6E-1S-WH-RC-FN12VXCR1](#) [6-1571986-9](#) [8007K26N324V52](#) [8055K23Z7V](#) [8055K32Z7V](#) [8055K52Z7V](#) [8138K20E6M50](#)
[PREDD4-07F-BB0FW](#) [PREDD5-07F-BB0GW](#) [999-16716-002](#) [A101J1V3Q004](#) [A103J1ZQ004](#) [A201J1AQ004](#) [A201J50ZQ004](#)
[H8653VBBG2577W](#) [HB130CHNWWNAAC](#) [R13112ABB-602W](#) [1251.0303](#) [1352.0107](#) [1500G51E](#) [1571099-3](#) [1571987-4](#) [1571987-5](#)
[1571988-5](#) [B123J77V7B2](#) [160212E](#) [1634200-7](#) [1801.1164](#) [PANEL-PLUG-VHP-BLACK](#) [PANEL-PLUG-VHP-WT](#) [K2ABAAAAAA](#)
[250011E714](#) [2600R21E](#) [260413E](#) [2639LH/2A7/127000L0](#) [LL3AZXX-100-XGT1](#) [LL3AZXX-100-XHS1](#) [LL3AZXX-100-XSD1](#) [30-695B](#)
[160311E](#) [A103J3ZQ004](#) [A201J61ZQ0004](#) [1852.1102](#) [1890.1104](#) [191.081.011](#) [AE107J1AQ004](#) [1935.3128](#) [1935.3133](#) [1MR7-B](#)
[SY236CD6U622](#)