

NOTES:

1. Circuit: ON/OFF
2. Operation force(Waterproof cap removal): 500±200gf
3. Electrical rating: 8A 250VAC (ULCUL CQC)
15A 125VAC (ULCUL CQC)
12(6)A 250VAC (ENEC17)
4. Contact resistance: <30mΩ
5. Insulation resistance: >100MΩ
(500VDC between open contacts)
6. Dielectric strength: >1500V 1 minute
7. Color: cover is red, body is black.
8. Comply with the requirements of the EU directive 2002/95/EC RoHs and subsequent amendments.
9. Life: The switch can satisfy the test standard of BPT0001 and life requirement of all the products.
10. Terminal: #187 TAB Terminal, accord the UL310 standard.
11. Satisfy the test requirement of PST-11, switch impact.
12. Waterproof cap Material PVC GM5075, Yellow card: E96789
13. UL file NO: E300970.
14. Waterproof cap hardness: 40° ±10°.
15. Glue the waterproof and the switch together. And be sure the waterproof does not shed when tension strength less than 3KG.
16. Change to low lead material.

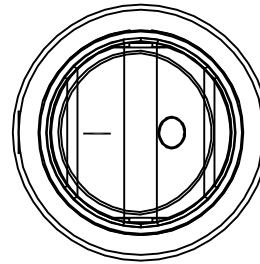

电话 : 0769-82210511-867
邮箱 : hooya89@hooya.hk
V : hooya89

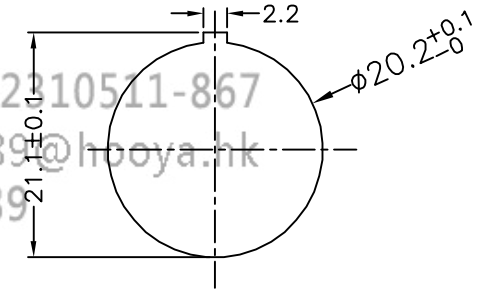

Panel cut out(Thickness: 1.54±0.1mm)

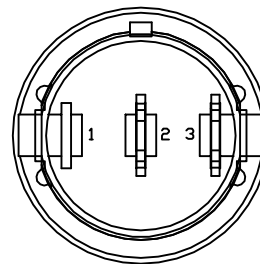
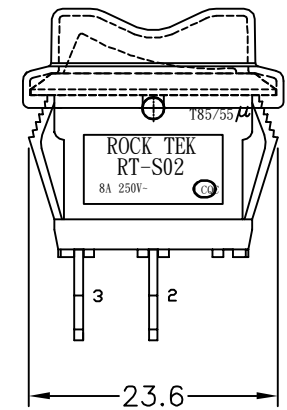
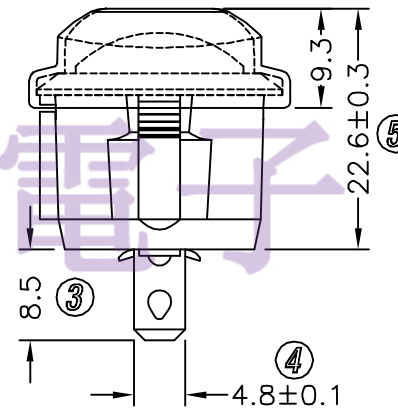
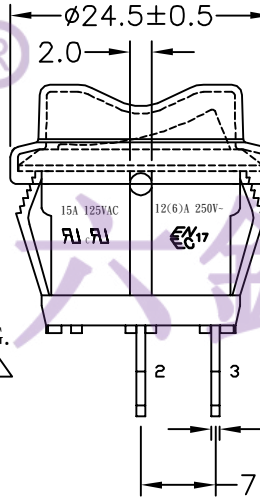

Circuit of Switch

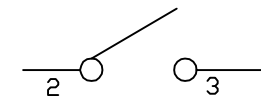

5	→	10	→	DIMENSIONAL TOLERANCES		APPROVED	CHECKED	DESIGN	DRAWN	ALL SIZE ARE IN	MM				
4	→	9	→	RANGE	TOLERANCE	 				SCALE	FIT	DRAWING NO. REV			
3	→	8	→	X	±0.3					MAT'L	***	RT-S02-117-RANBRC DC		WIF111003	C
2	→	7	→	X.X	±0.2					MATERIAL NO.					
1	→	6	→	X.XX	±0.1					DRAWING NO.					
NO	DESCRIPTION	NO	DESCRIPTION	ANGLES	±0.5°					LEGION ELECTRONIC & HARDWARE CO., LTD					

A

A

X-ON Electronics

Largest Supplier of Electrical and Electronic Components

Click to view similar products for [Rocker Switches](#) category:

Click to view products by [Legion](#) manufacturer:

Other Similar products are found below :

[LTI LA6E-1S-WH-RC-FN12VXCR1](#) [6-1571986-9](#) [8007K26N324V52](#) [8055K23Z7V](#) [8055K32Z7V](#) [8055K52Z7V](#) [8138K20E6M50](#)
[PREDD4-07F-BB0FW](#) [PREDD5-07F-BB0GW](#) [999-16716-002](#) [A101J1V3Q004](#) [A103J1ZQ004](#) [A201J1AQ004](#) [A201J50ZQ004](#)
[H8653VBBG2577W](#) [HB130CHNWWNAAC](#) [R13112ABB-602W](#) [1251.0303](#) [1352.0107](#) [1500G51E](#) [1571099-3](#) [1571987-4](#) [1571987-5](#)
[1571988-5](#) [B123J77V7B2](#) [160212E](#) [1634200-7](#) [1801.1164](#) [PANEL-PLUG-VHP-BLACK](#) [PANEL-PLUG-VHP-WT](#) [K2ABAAAAAA](#)
[250011E714](#) [2600R21E](#) [260413E](#) [2639LH/2A7/127000L0](#) [LL3AZXX-100-XGT1](#) [LL3AZXX-100-XHS1](#) [LL3AZXX-100-XSD1](#) [30-695B](#)
[160311E](#) [A103J3ZQ004](#) [A201J61ZQ0004](#) [1852.1102](#) [1890.1104](#) [191.081.011](#) [AE107J1AQ004](#) [1935.3128](#) [1935.3133](#) [1MR7-B](#)
[SY236CD6U622](#)