

1. 电路CIRCUIT: ON/OFF ;
2. 快插端子 QUICK CONNECTOR TYPE;
单刀单掷 (SINGLE POLE SINGLE THROW);
3. 额定值 RATING: 16A 125/250VAC (UL; C-UL);
16(4)A 250V~T125/55 (ENEC17; NEMKO; CQC; CB)
4. 柄的颜色 ACTUATOR COLOR: 黑色 BLACK
基座的颜色 HOUSING COLOR: 黑色 BLACK
5. 柄的印字形式 ACTUATOR PRINTING: 白色 "●" WHITE COLOR
6. 所有部件均使用环保材料
ALL MATERIALS USE IN CONFORMIY WITH THE RoHS DIRECTIVE

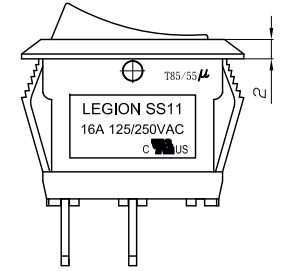

Panel cut out (Thickness: 3mm Max)

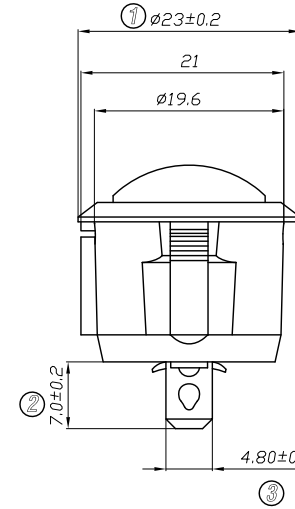
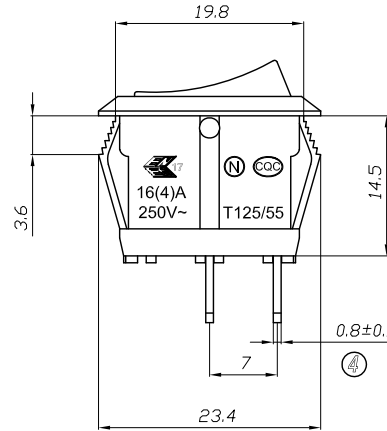
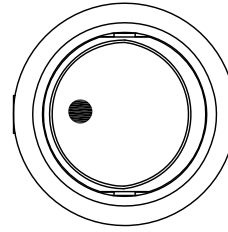
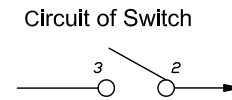
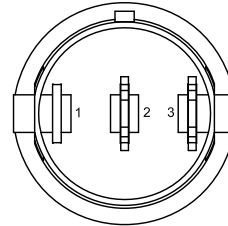
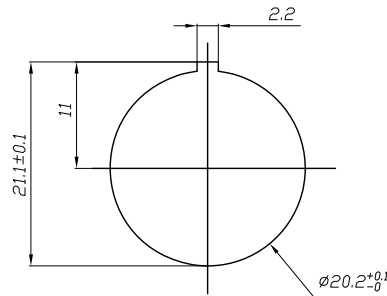

5	→	10	→	DIMENSIONAL TOLERANCES		APPROVED	CHECKED	DESIGN	DRAWN	ALL SIZE ARE IN	MM		
4	→	9	→	RANGE	TOLERANCE				LMC	SCALE	NO		
3	→	8	→	X	±0.30				2019.05.20	MAT'L	***	DRAWING NO.	
2	→	7	→	X.X	±0.20					MATERIAL NO.			REV.
1	→	6	→	X.XX	±0.10	LEGION ELECTRONIC & HARDWARE CO., LTD.				SS11-BBDWT-RR23-R	WIF120037	A0	
NO	DESCRIPTION	NO	DESCRIPTION	ANGLES	±1'								

X-ON Electronics

Largest Supplier of Electrical and Electronic Components

Click to view similar products for [Rocker Switches](#) category:

Click to view products by [Legion](#) manufacturer:

Other Similar products are found below :

[LTI LA6E-1S-WH-RC-FN12VXCR1](#) [6-1571986-9](#) [8007K26N324V52](#) [8055K23Z7V](#) [8055K32Z7V](#) [8055K52Z7V](#) [8138K20E6M50](#)
[PREDD4-07F-BB0FW](#) [PREDD5-07F-BB0GW](#) [999-16716-002](#) [A101J1V3Q004](#) [A103J1ZQ004](#) [A201J1AQ004](#) [A201J50ZQ004](#)
[H8653VBBG2577W](#) [HB130CHNWWNAAC](#) [R13112ABB-602W](#) [1251.0303](#) [1352.0107](#) [1500G51E](#) [1571099-3](#) [1571987-4](#) [1571987-5](#)
[1571988-5](#) [B123J77V7B2](#) [160212E](#) [1634200-7](#) [1801.1164](#) [PANEL-PLUG-VHP-BLACK](#) [PANEL-PLUG-VHP-WT](#) [K2ABAAAAAA](#)
[250011E714](#) [2600R21E](#) [260413E](#) [2639LH/2A7/127000L0](#) [LL3AZXX-100-XGT1](#) [LL3AZXX-100-XHS1](#) [LL3AZXX-100-XSD1](#) [30-695B](#)
[160311E](#) [A103J3ZQ004](#) [A201J61ZQ0004](#) [1852.1102](#) [1890.1104](#) [191.081.011](#) [AE107J1AQ004](#) [1935.3128](#) [1935.3133](#) [1MR7-B](#)
[SY236CD6U622](#)