



ROCKER SWITCH



SS31 SERIES



SPECIFICATION

Rating: 16A 125VAC 3/4HP(C-UL)
 16A 250VAC 3/4HP(C-UL)
 16(4)A 250V~T125/55(NEMKO, ENEC17, CB, CQC)
 10(2) 250V~T125/55(5E4)(NEMKO, ENEC17, CB, CQC)
 INITIAL CONTACT RESISTANCE: 20mΩ Max
 OPERATION FORCE: 300±200gf
 INSULATION RESISTANCE: 100mΩ MIN 500VDC
 WITHSTAND VOLTAGE: 1500VAC FOR 1MINUTE
 ENDURANCE: 10,000CYCLES



TERMINAL TYPE	
Q	QUICK-CONN 
A	QUICK-CONN 

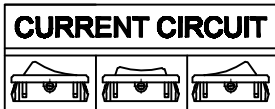

20	ON	-	OFF		40	ON	-	OFF	
21	(ON)	-	OFF	SPST	41	(ON)	-	OFF	DPST
22	ON	-	(OFF)		42	ON	-	(OFF)	
30	ON	-	ON		60	ON	-	ON	
31	(ON)	-	ON		61	(ON)	-	ON	
32	ON	OFF	ON	SPDT	62	ON	OFF	ON	DPDT
33	(ON)	OFF	ON		63	(ON)	OFF	ON	
34	(ON)	OFF	(ON)		64	(ON)	OFF	(ON)	

(-) MOMENTARY

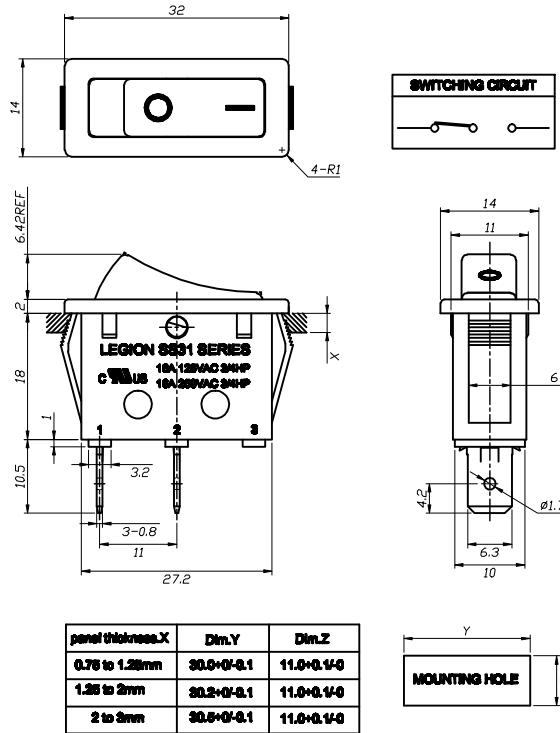

Terminal list

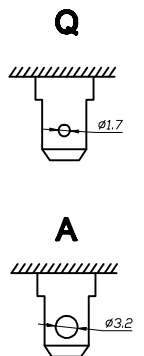

SS31 SERIES ORDERING SYSTEM

SS31 - B B I W Q - R S 2 0 - L 0 1 - R

MODEL NO.

ACTUATOR COLOR		HOUSING COLOR	
B	BLACK	W	WHITE
R	RED		

PRINTING COLOR
W WHITE
B BLACK
N NONE

ACTUATOR TYPE
R ROCKER
F FLAT
L WITH LENS



HOUSING TYPE
S SINGLE POLE
D DOUBLE POLE
T TWINS POLE

LAMP TYPE
L WITH LAMP
NONE

LIGHT COLOR
0 AMBER(S)
2 RED
3 GREEN
4 BLUE
NONE

RoHS DIRECTIVE	
R	MEET RoHS DIRECTIVE
	NONE

ACTUATOR/HOUSING PRINTING			
I	○	W	≡
N		R	

TERMINAL TYPE	
Q	QUICK-CONN 
A	QUICK-CONN 

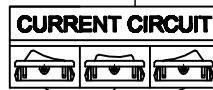

20	ON	-	OFF		40	ON	-	OFF	
21	(ON)	-	OFF	SPST	41	(ON)	-	OFF	DPST
22	ON	-	(OFF)		42	ON	-	(OFF)	
30	ON	-	ON		60	ON	-	ON	
31	(ON)	-	ON		61	(ON)	-	ON	
32	ON	OFF	ON	SPDT	62	ON	OFF	ON	DPDT
33	(ON)	OFF	ON		63	(ON)	OFF	ON	
34	(ON)	OFF	(ON)		64	(ON)	OFF	(ON)	

RESISTOR	
	NONE
1	100KΩ
2	200KΩ

(-) MOMENTARY

X-ON Electronics

Largest Supplier of Electrical and Electronic Components

Click to view similar products for [Rocker Switches](#) category:

Click to view products by [Legion](#) manufacturer:

Other Similar products are found below :

[LTILA6E-1S-WH-RC-FN12VXCR1](#) [6-1571986-9](#) [8055K23Z7V](#) [8055K52Z7V](#) [8138K20E6M50](#) [PREDD5-07F-BB0GW](#) [999-16716-002](#)
[999-16716-003](#) [A101J1V3Q004](#) [A101J2ZQ004](#) [A101J51CB0004](#) [A103J1ZQ004](#) [A201J1AQ004](#) [A201J3ZB004](#) [A201J50ZQ004](#)
[A203J51ZQ0004](#) [A435S1YZQ](#) [H8500XBBBBL-A](#) [H8653VBBG2577W](#) [HB130CHNWWNAAC](#) [R13112ABB-602W](#) [1251.0303](#)
[AE205J60V3B004](#) [1352.0107](#) [1363.0201](#) [1500G51E](#) [1571099-3](#) [1571987-4](#) [1571987-5](#) [1571988-5](#) [B123J77V7B2](#) [B226J50W4Q22P](#)
[B433J37ZQ22M](#) [160212E](#) [1634200-7](#) [1801.1164](#) [1831.1102](#) [1839.1502](#) [PANEL-PLUG-VHP-BLACK](#) [PANEL-PLUG-VHP-WT](#)
[K1ABBSCADN](#) [K2ABAAAAAA](#) [KG312A2DXD246X](#) [250011E714](#) [2600R21E](#) [260413E](#) [2637LH/2A7/122048L0](#) [2639LH/2A7/127000L0](#)
[LL3AZXX-100-XGT1](#) [LL3AZXX-100-XHS1](#)