

Top View

SOT-23

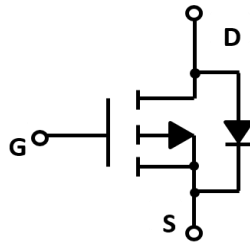
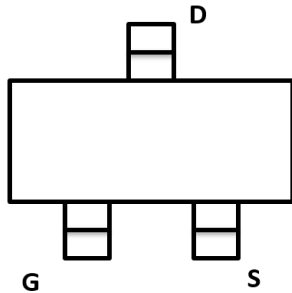

### Product Summary

- $V_{DS}$  -30V
- $I_D$  -4.1A
- $R_{DS(ON)}$ ( at  $V_{GS}=-10V$ ) <60 mohm
- $R_{DS(ON)}$ ( at  $V_{GS}=-4.5V$ ) <75 mohm

### General Description

- Trench Power LV MOSFET technology
- High density cell design for Low  $R_{DS(ON)}$
- High Speed switching

### Applications

- Battery protection
- Load switch
- Power management

### ■ Absolute Maximum Ratings ( $T_A=25^\circ\text{C}$ unless otherwise noted)

Parameter	Symbol	Maximum	Unit
Drain-source Voltage	$V_{DS}$	-30	V
Gate-source Voltage	$V_{GS}$	$\pm 20$	V
Drain Current	$I_D$	$T_A=25^\circ\text{C}$ @ Steady State	-4.1
		$T_A=70^\circ\text{C}$ @ Steady State	-3.2
Pulsed Drain Current <sup>A</sup>	$I_{DM}$	-15	A
Total Power Dissipation @ $T_A=25^\circ\text{C}$	$P_D$	1.5	W
Thermal Resistance Junction-to-Ambient @ Steady State <sup>B</sup>	$R_{\theta JA}$	82	$^\circ\text{C}/\text{W}$
Junction and Storage Temperature Range	$T_J, T_{STG}$	-55~+150	$^\circ\text{C}$

### ■ Ordering Information (Example)

PREFERED P/N	Marking	MINIMUM PACKAGE(pcs)	DELIVERY MODE
DMG2307LQ	3407	3000	7" reel

**■ Electrical Characteristics (T<sub>J</sub>=25°C unless otherwise noted)**

Parameter	Symbol	Conditions	Min	Typ	Max	Units
<b>Static Parameter</b>						
Drain-Source Breakdown Voltage	BV <sub>DSS</sub>	V <sub>GS</sub> = 0V, I <sub>D</sub> =-250μA	-30			V
Zero Gate Voltage Drain Current	I <sub>DSS</sub>	V <sub>DS</sub> =-30V, V <sub>GS</sub> =0V, T <sub>C</sub> =25°C			-1	μA
Gate-Body Leakage Current	I <sub>GSS</sub>	V <sub>GS</sub> = ±20V, V <sub>DS</sub> =0V			±100	nA
Gate Threshold Voltage	V <sub>GS(th)</sub>	V <sub>DS</sub> = V <sub>GS</sub> , I <sub>D</sub> =-250μA	-1.0	-1.5	-2.4	V
Static Drain-Source On-Resistance	R <sub>DS(ON)</sub>	V <sub>GS</sub> = -10V, I <sub>D</sub> =-4.1A		46	60	mΩ
		V <sub>GS</sub> = -4.5V, I <sub>D</sub> =-3.5A		58	75	
Diode Forward Voltage	V <sub>SD</sub>	I <sub>S</sub> =-4.1A, V <sub>GS</sub> =0V		-0.8	-1.2	V
Maximum Body-Diode Continuous Current	I <sub>S</sub>				-4.1	A
<b>Dynamic Parameters</b>						
Input Capacitance	C <sub>iss</sub>	V <sub>DS</sub> =-15V, V <sub>GS</sub> =0V, f=1MHZ		580		pF
Output Capacitance	C <sub>oss</sub>			98		
Reverse Transfer Capacitance	C <sub>rss</sub>			74		
<b>Switching Parameters</b>						
Total Gate Charge	Q <sub>g</sub>	V <sub>GS</sub> =-10V, V <sub>DS</sub> =-15V, I <sub>D</sub> =-4.1A		6.8		nC
Gate Source Charge	Q <sub>gs</sub>			1.0		
Gate Drain Charge	Q <sub>gd</sub>			1.4		
Turn-on Delay Time	t <sub>D(on)</sub>	V <sub>GS</sub> =-10V, V <sub>DD</sub> =-15V, R <sub>L</sub> =15Ω, I <sub>D</sub> =-1A, R <sub>GEN</sub> =2.5Ω		14		ns
Turn-on Rise Time	t <sub>r</sub>			61		
Turn-off Delay Time	t <sub>D(off)</sub>			19		
Turn-off Fall Time	t <sub>f</sub>			10		

A. Pulse Test: Pulse Width ≤ 300us, Duty cycle ≤ 2%.

B. Device mounted on FR-4 PCB, 1 inch x 0.85 inch x 0.062 inch.

## ■ Typical Performance Characteristics

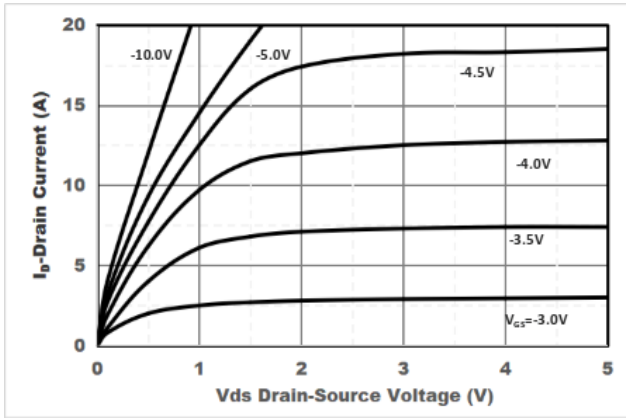

Figure1. Output Characteristics

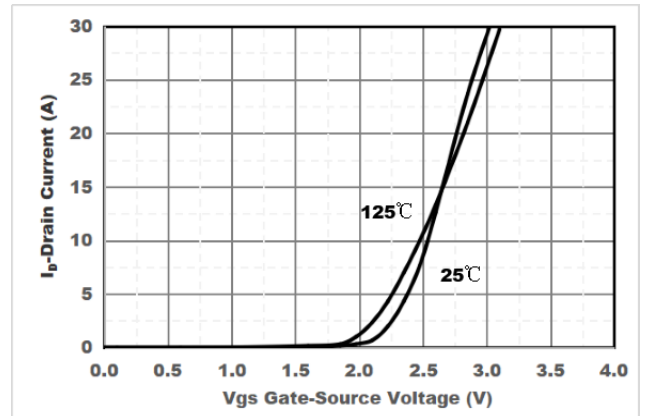

Figure2. Transfer Characteristics

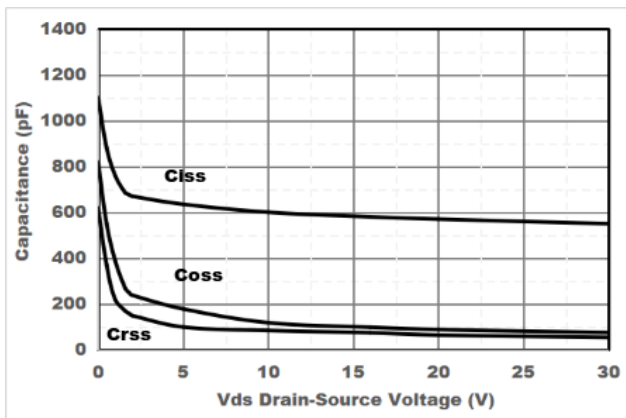

Figure3. Capacitance Characteristics

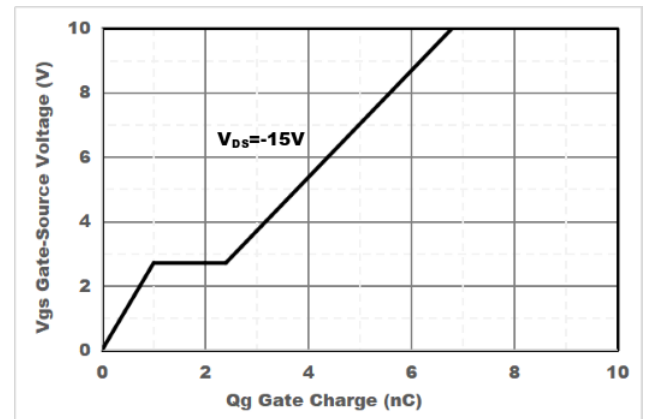

Figure4. Gate Charge

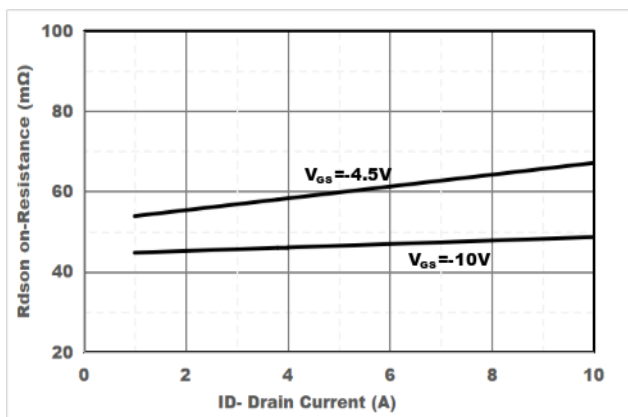

Figure5. Drain-Source on Resistance

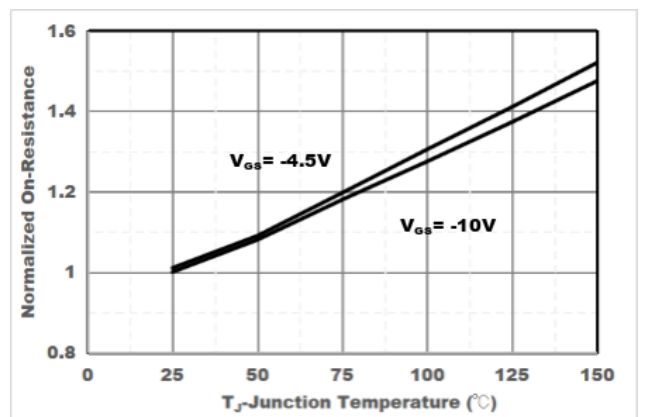

Figure6. Drain-Source on Resistance

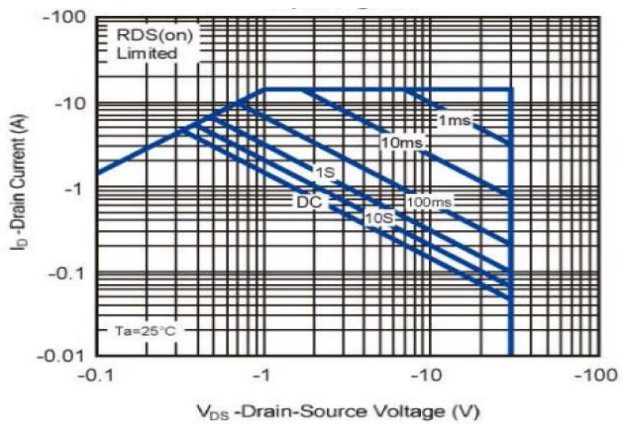

Figure7. Safe Operation Area

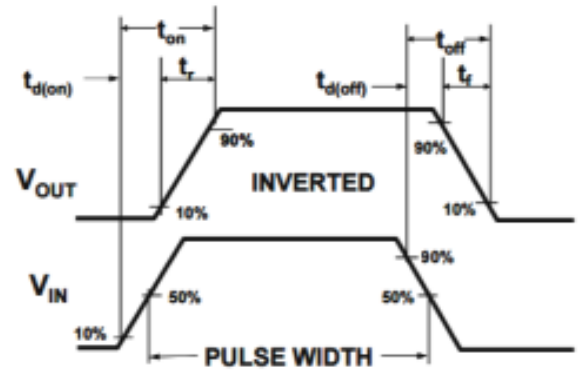
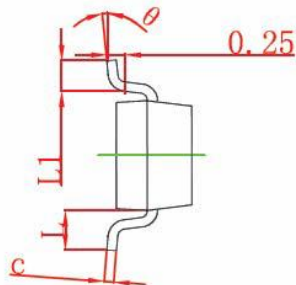
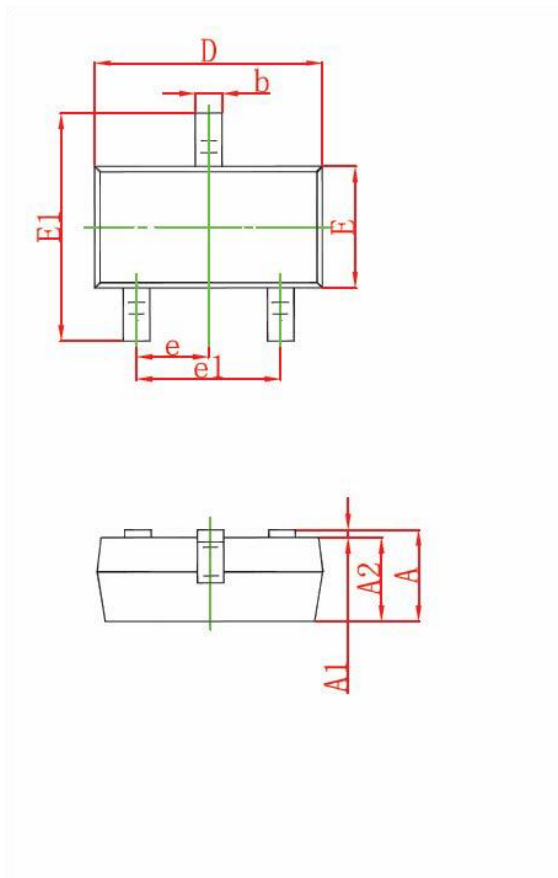

Figure8. Switching wave

## ■ SOT-23 Package information



Symbol	Dimensions In Millimeters		Dimensions In Inches	
	Min	Max	Min	Max
A	0.900	1.150	0.035	0.045
A1	0.000	0.100	0.000	0.004
A2	0.900	1.050	0.035	0.041
b	0.300	0.500	0.012	0.020
c	0.080	0.150	0.003	0.006
D	2.800	3.000	0.110	0.118
E	1.200	1.400	0.047	0.055
E1	2.250	2.550	0.089	0.100
e	0.950 TYP		0.037 TYP	
e1	1.800	2.000	0.071	0.079
L	0.550 REF		0.022 REF	
L1	0.300	0.500	0.012	0.020
θ	0°	8°	0°	8°

## ■ SOT-23 Suggested Pad Layout

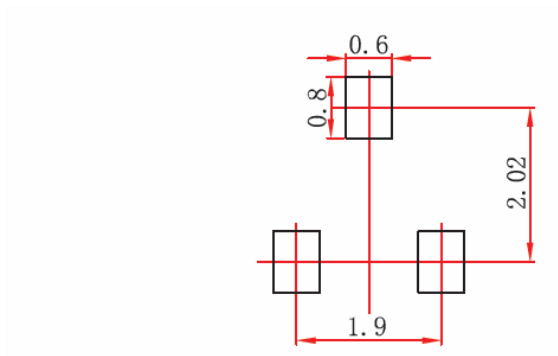

**Note:**

1. Controlling dimension: in millimeters.
2. General tolerance:  $\pm 0.05\text{mm}$ .
3. The pad layout is for reference purposes only.

## X-ON Electronics

Largest Supplier of Electrical and Electronic Components

*Click to view similar products for [MOSFET](#) category:*

*Click to view products by [Leiditech](#) manufacturer:*

Other Similar products are found below :

[614233C](#) [648584F](#) [IRFD120](#) [IRFF430](#) [JANTX2N5237](#) [2N7000](#) [FCA20N60\\_F109](#) [FDZ595PZ](#) [AOD464](#) [2SK2267\(Q\)](#) [2SK2545\(Q,T\)](#)  
[405094E](#) [423220D](#) [MIC4420CM-TR](#) [VN1206L](#) [614234A](#) [715780A](#) [SSM6J414TU,LF\(T](#) [751625C](#) [PSMN4R2-30MLD](#)  
[TK31J60W5,S1VQ\(O](#) [2SK2614\(TE16L1,Q\)](#) [DMN1017UCP3-7](#) [EFC2J004NUZTDG](#) [FCAB21350L1](#) [P85W28HP2F-7071](#) [DMN1053UCP4-7](#)  
[NTE2384](#) [NTE2969](#) [NTE6400A](#) [DMN2080UCB4-7](#) [DMN61D9UWQ-13](#) [US6M2GTR](#) [DMN31D5UDJ-7](#) [SSM6P54TU,LF](#) [DMP22D4UFO-](#)  
[7B](#) [IPS60R3K4CEAKMA1](#) [DMN1006UCA6-7](#) [DMN16M9UCA6-7](#) [STF5N65M6](#) [STU5N65M6](#) [C3M0021120D](#) [DMN13M9UCA6-7](#)  
[BSS340NWH6327XTSA1](#) [MCM3400A-TP](#) [DMTH10H4M6SPS-13](#) [IRF40SC240ARMA1](#) [IPS60R1K0PFD7SAKMA1](#)  
[IPS60R360PFD7SAKMA1](#) [IPS60R600PFD7SAKMA1](#)