

P-Channel Enhancement Mode Power MOSFET

General Description

The IRLML9303 uses advanced trench technology to provide excellent $R_{DS(ON)}$, low gate charge and operation with gate voltages as low as 2.5V. This device is suitable for use as a load switch or in PWM applications.

Features

V_{DS}	-30V
I_D (at $V_{GS}=-10V$)	-5.0A
$R_{DS(ON)}$ (at $V_{GS}=-10V$)	50m Ω (Max)
$R_{DS(ON)}$ (at $V_{GS}=-4.5V$)	65m Ω (Max)
$R_{DS(ON)}$ (at $V_{GS}=-2.5V$)	90m Ω (Max)

SOT23

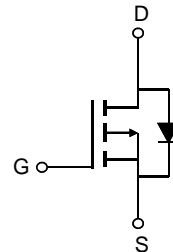
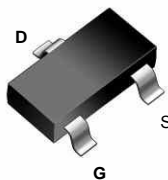

Absolute Maximum Ratings $T_A=25^\circ\text{C}$ unless otherwise noted

Parameter	Symbol	Maximum	Units	
Drain-Source Voltage	V_{DS}	-30	V	
Gate-Source Voltage	V_{GS}	± 12	V	
Drain Current-Continuous	TC=25 $^\circ\text{C}$	I_D	-5.0	A
	TC=100 $^\circ\text{C}$	I_D	-3.5	A
Drain Current – Pulsed	I_{DM}	-20	A	
Maximum Power Dissipation	P_D	2.1	W	
Junction and Storage Temperature Range	T_J, T_{STG}	-55 To 150	$^\circ\text{C}$	

Thermal Characteristics

Parameter	Symbol	Typ	Max	Unit
Thermal Resistance junction-case	$R_{\theta Jc}$		1.1	$^\circ\text{C}/\text{W}$
Thermal Resistance junction-to-Ambient	$R_{\theta JA}$		60	$^\circ\text{C}/\text{W}$

Electrical Characteristics (T_J=25°C unless otherwise noted)

Symbol	Parameter	Condition	Min	Typ	Max	Unit
STATIC PARAMETERS						
BV _{DSS}	Drain-Source Breakdown Voltage	V _{GS} =0V I _D =-250μA	-30			V
I _{DSS}	Zero Gate Voltage Drain Current	V _{DS} =-30V, V _{GS} =0V			1	μA
I _{GSS}	Gate-Body Leakage Current	V _{GS} =±12V, V _{DS} =0V			±100	nA
V _{GS(th)}	Gate Threshold Voltage	V _{DS} =V _{GS} , I _D =-250μA	-0.5	-0.9	-1.5	V
R _{DS(ON)}	Drain-Source On-State Resistance	V _{GS} =-10V, I _D =-4.0A		41	50	mΩ
		V _{GS} =-4.5V, I _D =-3.5A		50	65	mΩ
		V _{GS} =-2.5V, I _D =-2.0A		60	90	mΩ
DYNAMIC PARAMETERS						
C _{ISS}	Input Capacitance	V _{DS} =-15V, V _{GS} =0V, F=1.0MHz		640		pF
C _{OSS}	Output Capacitance			80		pF
C _{RSS}	Reverse Transfer Capacitance			55		pF
SWITCHING PARAMETERS						
t _{d(on)}	Turn-on Delay Time	V _{DS} =-15V, I _D =-1A, V _{GS} =-10V, R _G =3Ω		6.5		nS
t _r	Turn-on Rise Time			3.5		nS
t _{d(off)}	Turn-Off Delay Time			41		nS
t _f	Turn-Off Fall Time			9		nS
Q _g	Total Gate Charge	V _{DS} =-15V, I _D =-4.0A, V _{GS} =-10V		14		nC
Q _{gs}	Gate-Source Charge			1.5		nC
Q _{gd}	Gate-Drain Charge			1.6		nC
V _{SD}	Diode Forward Voltage	V _{GS} =0V, I _{SD} =-1A		0.72	1.4	V
R _g	Gate resistance	V _{GS} =0V, V _{DS} =0V, F=1MHz		7		Ω

Note:

1. Repetitive Rating : Pulsed width limited by maximum junction temperature.
2. The data tested by pulsed , pulse width ≅ 300us , duty cycle ≅ 2%.
3. Essentially independent of operating temperature.

TYPICAL ELECTRICAL AND THERMAL CHARACTERISTICS

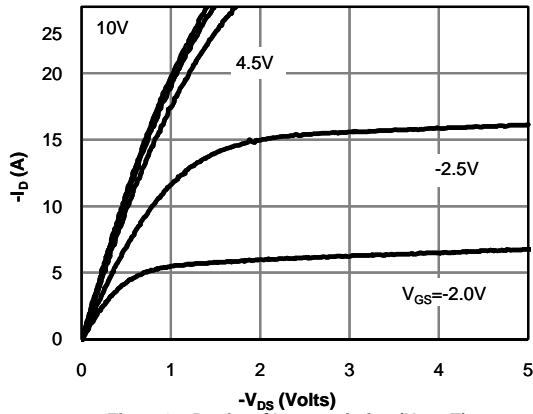

Fig 1: On-Region Characteristics (Note E)

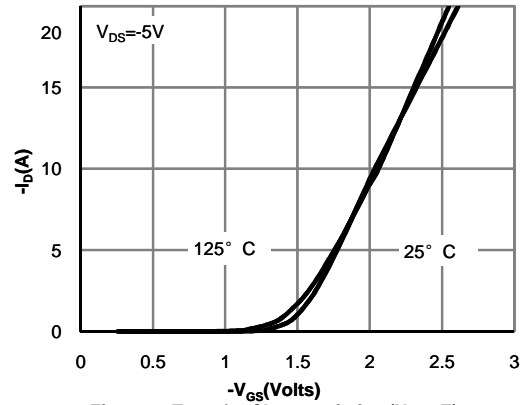

Figure 2: Transfer Characteristics (Note E)

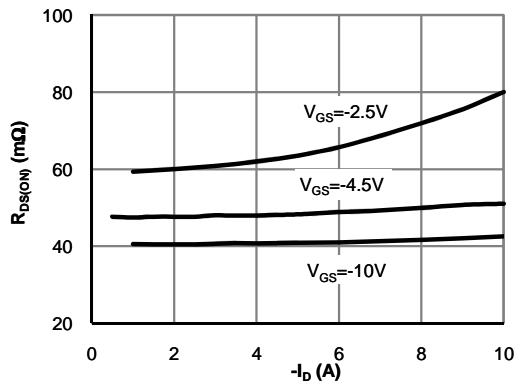

Figure 3: On-Resistance vs. Drain Current and Gate Voltage (Note E)

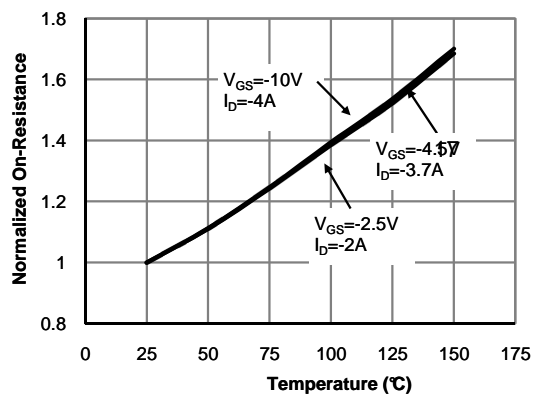

Figure 4: On-Resistance vs. Junction Temperature (Note E)

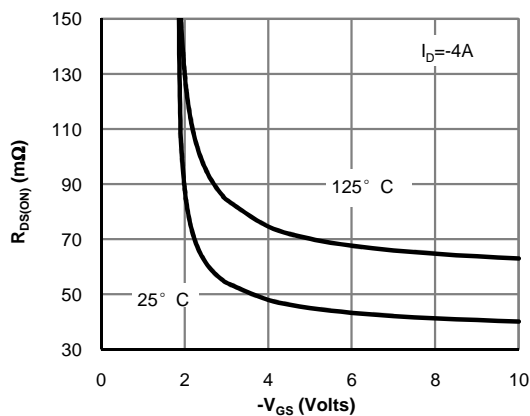

Figure 5: On-Resistance vs. Gate-Source Voltage (Note E)

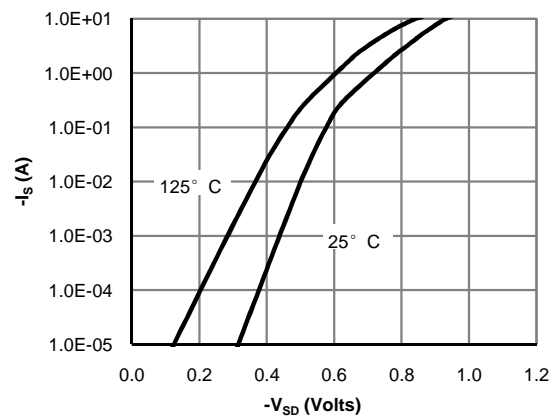

Figure 6: Body-Diode Characteristics (Note E)

TYPICAL ELECTRICAL AND THERMAL CHARACTERISTICS

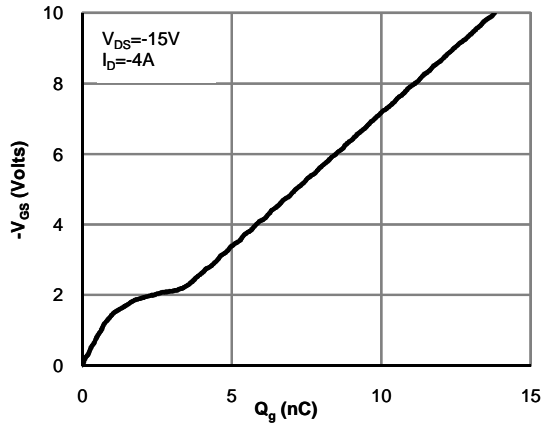

Figure 7: Gate-Charge Characteristics

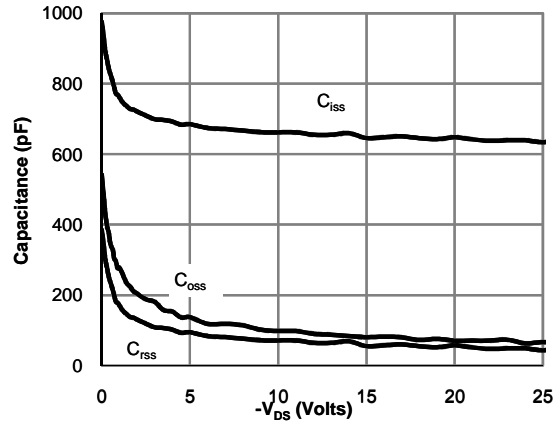

Figure 8: Capacitance Characteristics

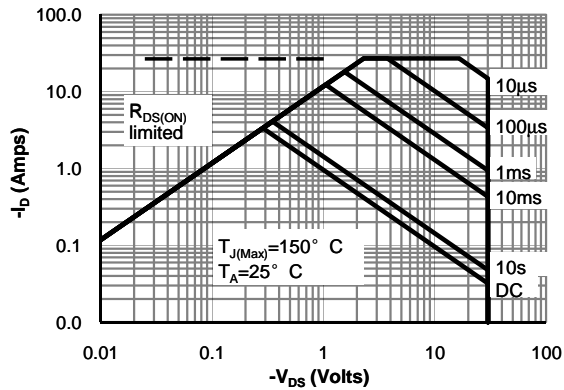

Figure 9: Maximum Forward Biased Safe Operating Area (Note F)

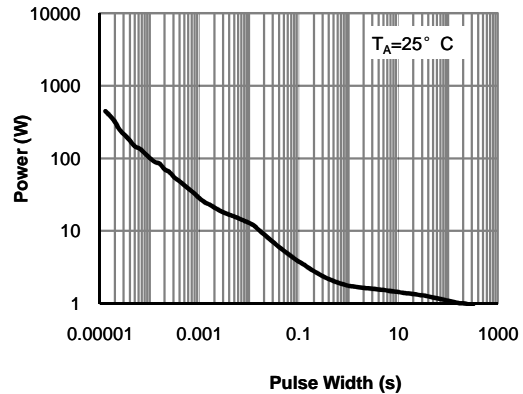

Figure 10: Single Pulse Power Rating Junction-to-Ambient (Note F)

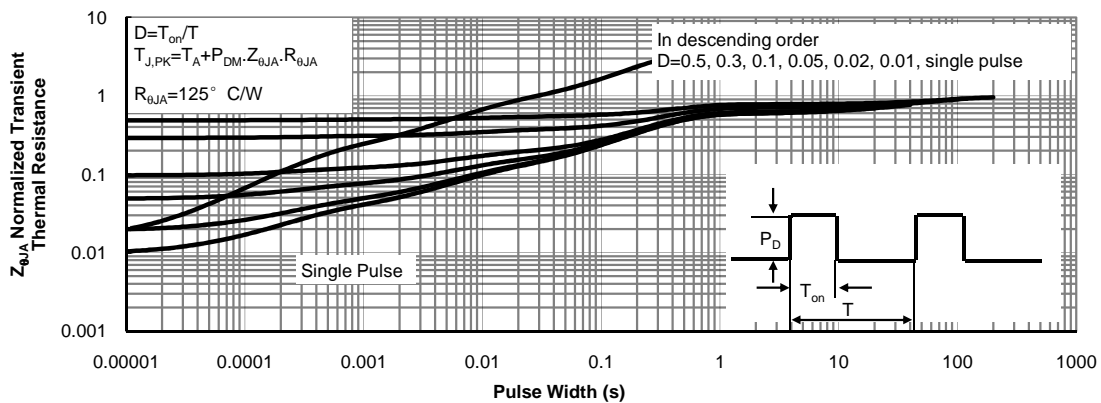
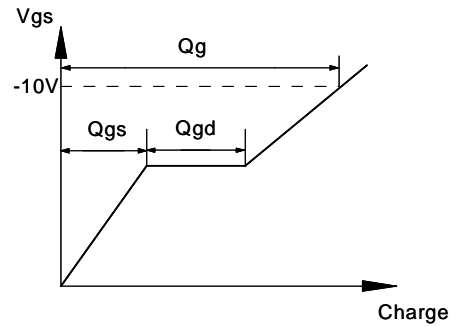
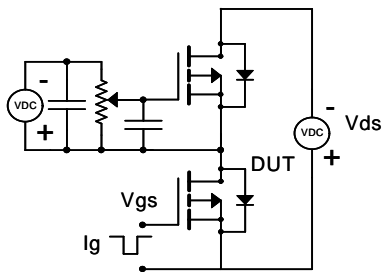
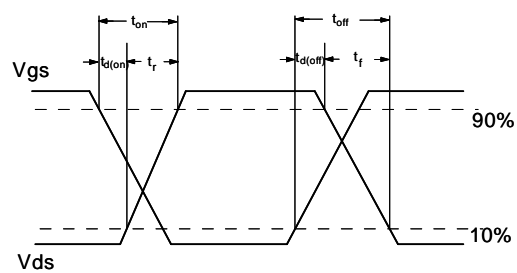
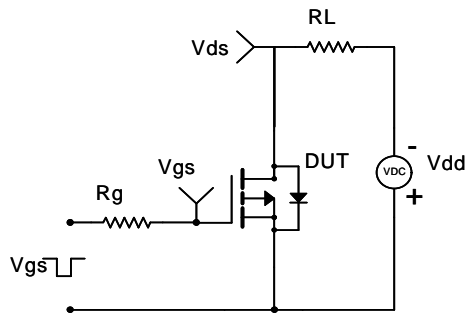

Figure 11: Normalized Maximum Transient Thermal Impedance (Note F)

Gate Charge Test Circuit & Waveform



Resistive Switching Test Circuit & Waveforms



Unclamped Inductive Switching (UIS) Test Circuit & Waveforms

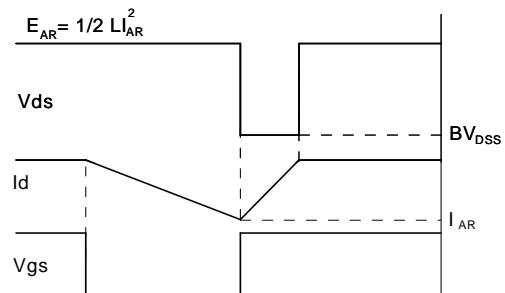
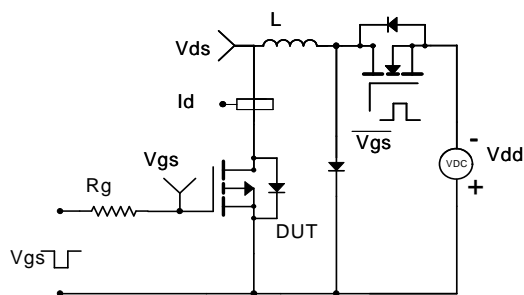

Diode Recovery Test Circuit & Waveforms

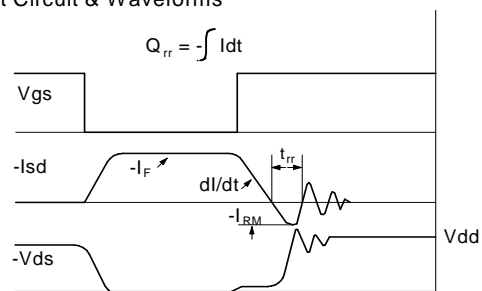
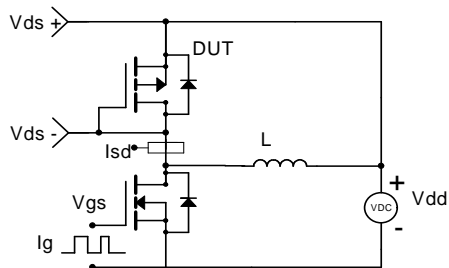

SOT23 PACKAGE INFORMATION

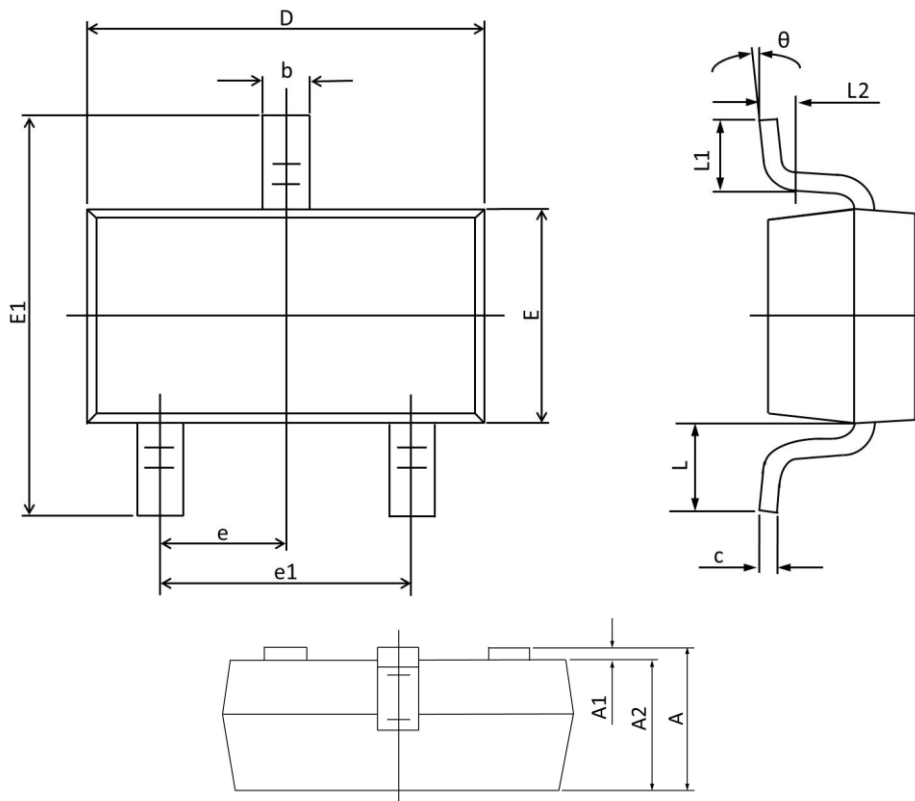

Symbol	Dimensions In Millimeters		Dimensions In Inches	
	Max	Min	Max	Min
A	1.150	0.900	0.045	0.035
A1	0.100	0.000	0.004	0.000
A2	1.050	0.900	0.041	0.035
b	0.500	0.300	0.020	0.012
c	0.150	0.080	0.006	0.003
D	3.000	2.800	0.118	0.110
E	1.400	1.200	0.055	0.047
E1	2.550	2.250	0.100	0.089
e	0.95 TYP.		0.037 TYP.	
e1	2.000	1.800	0.079	0.071
L	0.55 REF.		0.022 REF.	
L1	0.500	0.300	0.020	0.012
L2	0.25 TYP.		0.01 TYP.	
θ	8°	0°	8°	0°

Shanghai Leiditech Electronic Co.,Ltd
 Email: sale1@leiditech.com
 Tel : +86- 021 50828806
 Fax : +86- 021 50477059

X-ON Electronics

Largest Supplier of Electrical and Electronic Components

Click to view similar products for [MOSFET](#) category:

Click to view products by [Leiditech](#) manufacturer:

Other Similar products are found below :

[614233C](#) [648584F](#) [IRFD120](#) [IRFF430](#) [JANTX2N5237](#) [2N7000](#) [FCA20N60_F109](#) [FDZ595PZ](#) [AOD464](#) [2SK2267\(Q\)](#) [2SK2545\(Q,T\)](#)
[405094E](#) [423220D](#) [MIC4420CM-TR](#) [VN1206L](#) [614234A](#) [715780A](#) [SSM6J414TU,LF\(T](#) [751625C](#) [PSMN4R2-30MLD](#)
[TK31J60W5,S1VQ\(O](#) [2SK2614\(TE16L1,Q\)](#) [DMN1017UCP3-7](#) [EFC2J004NUZTDG](#) [FCAB21350L1](#) [P85W28HP2F-7071](#) [DMN1053UCP4-7](#)
[NTE2384](#) [NTE2969](#) [NTE6400A](#) [DMN2080UCB4-7](#) [DMN61D9UWQ-13](#) [US6M2GTR](#) [DMN31D5UDJ-7](#) [SSM6P54TU,LF](#) [DMP22D4UFO-](#)
[7B](#) [IPS60R3K4CEAKMA1](#) [DMN1006UCA6-7](#) [DMN16M9UCA6-7](#) [STF5N65M6](#) [STU5N65M6](#) [C3M0021120D](#) [DMN13M9UCA6-7](#)
[BSS340NWH6327XTSA1](#) [MCM3400A-TP](#) [DMTH10H4M6SPS-13](#) [IRF40SC240ARMA1](#) [IPS60R1K0PFD7SAKMA1](#)
[IPS60R360PFD7SAKMA1](#) [IPS60R600PFD7SAKMA1](#)