

60 N-Channel Enhancement Mode Power MOSFET

Description

The NVTYS010N06CL uses advanced technology to provide excellent $R_{DS(ON)}$, low gate charge and operation with gate voltages as low as 4.5V. This device is suitable for use as a Battery protection or in other Switching application.

General Features

$V_{DS} = 60V$ $I_D = 65A$

$R_{DS(ON)} < 10m\Omega$ @ $V_{GS}=10V$ (Type: 7.5m Ω)

Application

Battery protection

Load switch

Uninterruptible power supply

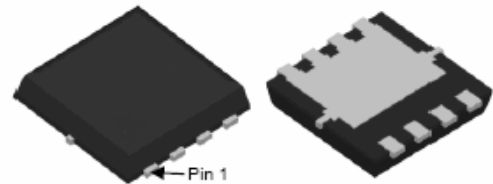
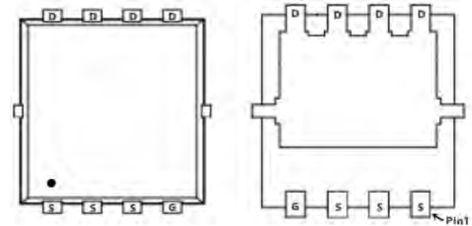
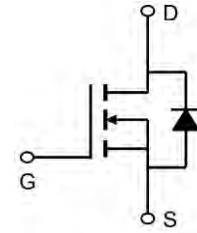

Package Marking and Ordering Information

Product ID	Pack	Marking	Qty(PCS)
NVTYS010N06CL	DFN3*3-8L	AP65N06DF XXX YYYY	5000PCS

Absolute Maximum Ratings@ $T_j=25^\circ C$ (unless otherwise specified)

Symbol	Parameter	Value	Unit
V _{DS}	Drain source voltage	60	V
V _{GS}	Gate source voltage	±20	V
$I_D@T_A=25^\circ C$	Continuous drain current	20	A
$I_D@T_A=70^\circ C$	Continuous drain current	11	A
IDM	Pulsed drain current	60	A
$P_D@T_A=25^\circ C$	Power dissipation	60	W
EAS	Single pulsed avalanche energy	30	mJ
TSTG	Storage Temperature Range	-55 to 150	°C
T _j	Operation and storage temperature	-55 to 150	°C
R _{θJC}	Thermal resistance, junction-case	2.1	°C/W
R _{θJA}	Thermal resistance, junction-ambient ⁵	85	°C/W

Electrical Characteristics (T_J=25°C, unless otherwise noted)

Symbol	Parameter	Test condition	Min.	Typ.	Max.	Unit
BVDSS	Drain-source breakdown voltage	V _{GS} =0 V, I _D =250 μA	60	68		V
VGS(th)	Gate threshold voltage	V _{DS} =V _{GS} , I _D =250 μA	1.2	1.5	2.5	V
RDS(ON)	Drain-source on-state resistance	V _{GS} =10 V, I _D =20 A		7.5	10	mΩ
RDS(ON)	Drain-source on-state resistance	V _{GS} =4.5 V, I _D =10 A		10	13	mΩ
IGSS	Gate-source leakage current	V _{GS} =±20 V			±100	nA
IDSS	Drain-source leakage current	V _{DS} =60 V, V _{GS} =0 V			1	μA
Ciss	Input capacitance	V _{GS} =0 V, V _{DS} =50 V, f=100 kHz		1182.1		pF
Coss	Output capacitance			199.5		pF
Crss	Reverse transfer capacitance			4.1		pF
td(on)	Turn-on delay time	V _{GS} =10 V, V _{DS} =50 V, R _G =2 Ω, I _D =10 A		17.9		ns
t _r	Rise time			4.0		ns
td(off)	Turn-off delay time			34.9		ns
t _f	Fall time			5.5		ns
Q _g	Total gate charge	I _D =10 A, V _{DS} =50 V, V _{GS} =10 V		18.4		nC
Q _{gs}	Gate-source charge			3.3		nC
Q _{gd}	Gate-drain charge			3.1		nC
V _{plateau}	Gate plateau voltage			2.8		V
I _S	Diode forward current	V _{GS} <V _{th}			60	A
ISP	Pulsed source current				180	
VSD	Diode forward voltage	I _S =20 A, V _{GS} =0 V			1.3	V
trr	Reverse recovery time	I _S =10 A, di/dt=100 A/μs		41.8		ns
Q _{rr}	Reverse recovery charge			36.1		nC
I _{rrm}	Peak reverse recovery current			1.4		A

Note

1. Calculated continuous current based on maximum allowable junction temperature.
2. Repetitive rating; pulse width limited by max. junction temperature.
3. Pd is based on max. junction temperature, using junction-case thermal resistance.
4. V_{DD}=50 V, R_G=50 Ω, L=0.3 mH, starting T_J=25 °C.
5. The value of R_{θJA} is measured with the device mounted on 1 in 2 FR-4 board with 2oz. Copper, in a still air environment with T_a=25 °C.

Typical Characteristics

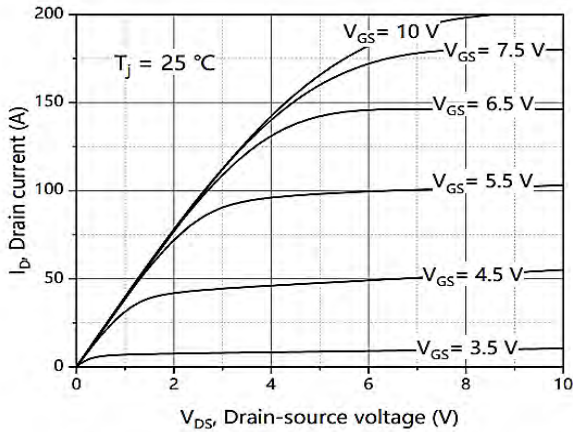

Figure 1. Typ. output characteristics

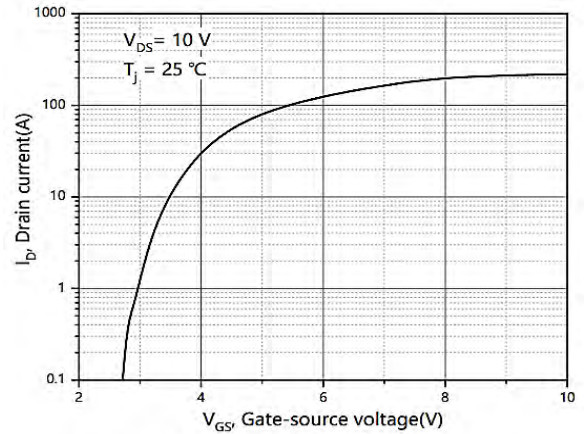

Figure 2. Typ. transfer characteristics

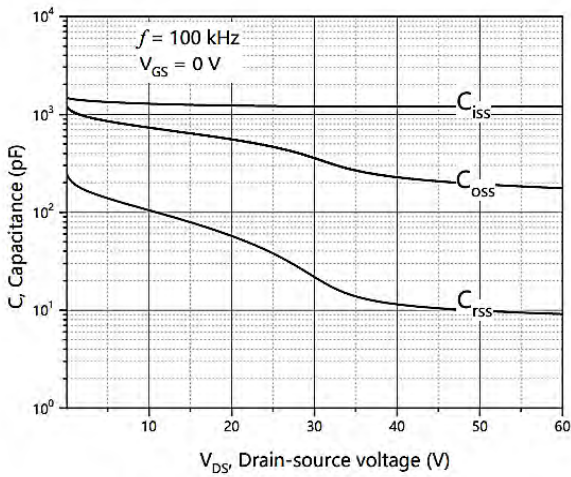

Figure 3. Typ. capacitances

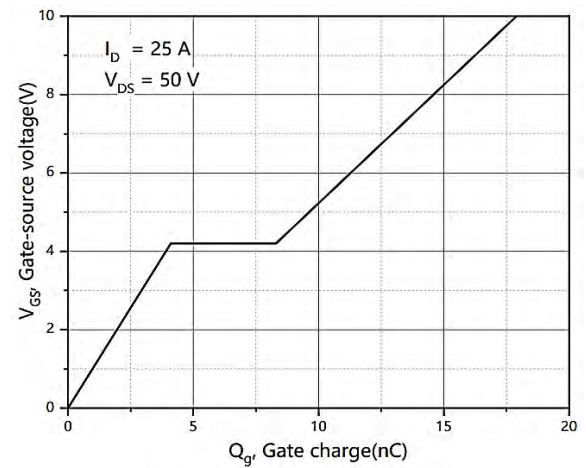

Figure 4. Typ. gate charge

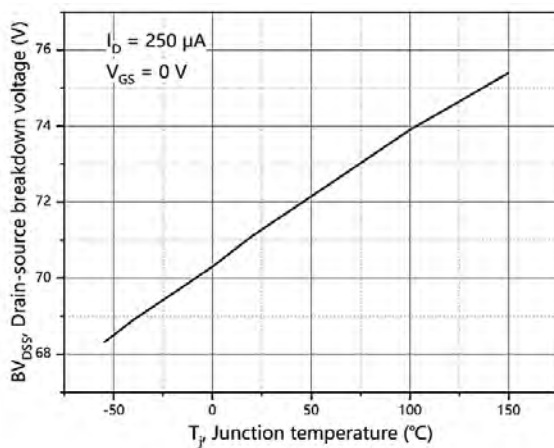

Figure 5. Drain-source breakdown voltage

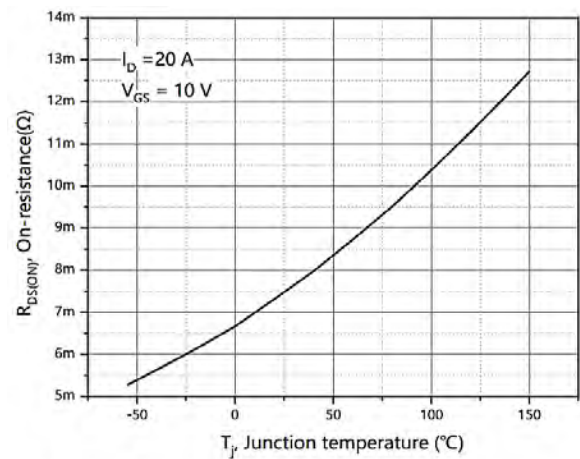

Figure 6. Drain-source on-state resistance

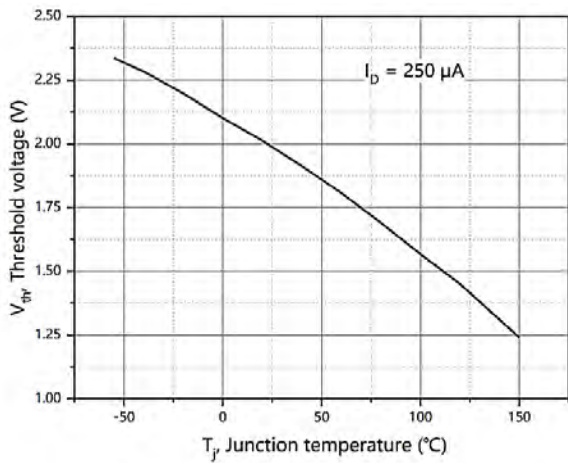

Figure 7. Threshold voltage

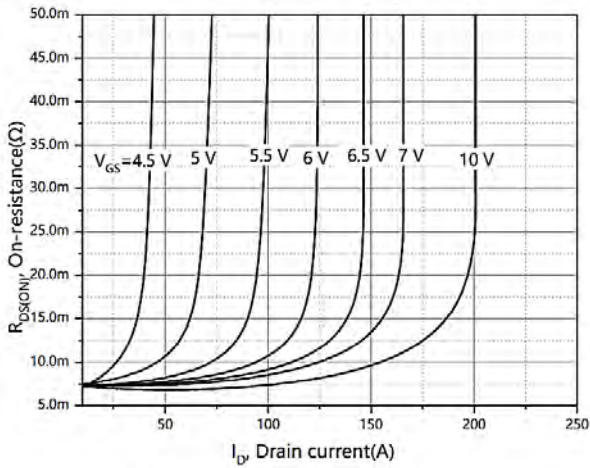

Figure 9. Drain-source on-state resistance

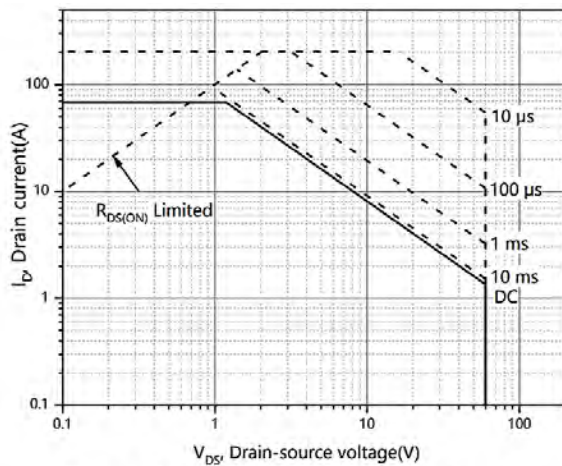

Figure 11. Safe operation area $T_C=25\text{ }^\circ\text{C}$

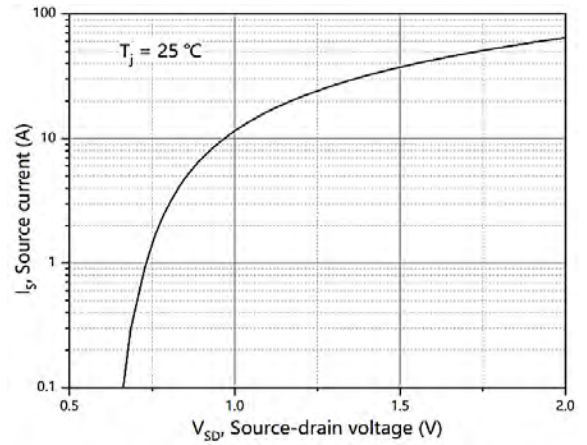

Figure 8. Forward characteristic of body diode

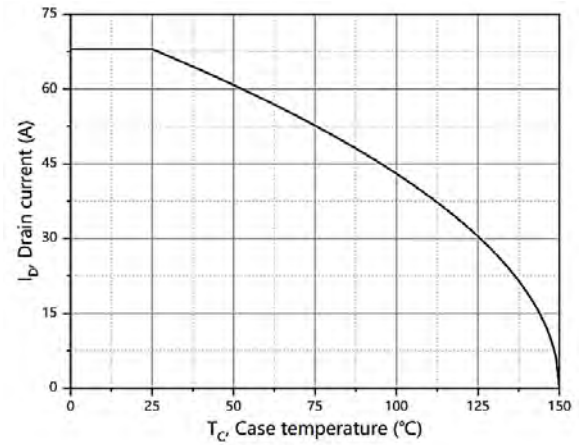

Figure 10. Drain current

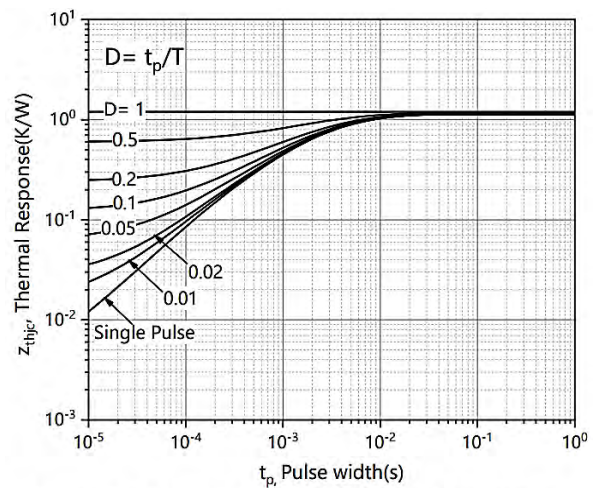
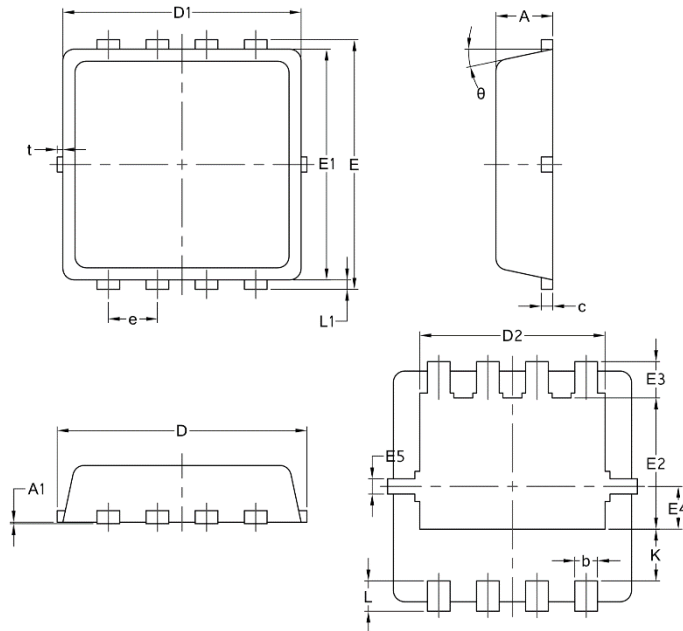

Figure 12. Max. transient thermal impedance

Package Mechanical Data-DFN3*3-8L Single



Symbol	Common		
	mm		
	Mim	Nom	Max
A	0.70	0.75	0.85
A1	/	/	0.05
b	0.20	0.30	0.40
c	0.10	0.152	0.25
D	3.15	3.30	3.45
D1	3.00	3.15	3.25
D2	2.29	2.45	2.65
E	3.15	3.30	3.45
E1	2.90	3.05	3.20
E2	1.54	1.74	1.94
E3	0.28	0.48	0.65
E4	0.37	0.57	0.77
E5	0.10	0.20	0.30
e	0.60	0.65	0.70
K	0.59	0.69	0.89
L	0.30	0.40	0.50
L1	0.06	0.125	0.20
t	0	0.075	0.13
Φ	10	12	14

X-ON Electronics

Largest Supplier of Electrical and Electronic Components

Click to view similar products for [MOSFET](#) category:

Click to view products by [Leiditech](#) manufacturer:

Other Similar products are found below :

[MCH3443-TL-E](#) [MCH6422-TL-E](#) [NTNS3A92PZT5G](#) [IRFD120](#) [JANTX2N5237](#) [2N7000](#) [2SK2464-TL-E](#) [2SJ277-DL-E](#) [2SK2267\(Q\)](#)
[2SK2545\(Q,T\)](#) [405094E](#) [423220D](#) [MIC4420CM-TR](#) [VN1206L](#) [614234A](#) [715780A](#) [SSM6J414TU,LF\(T](#) [751625C](#) [IRS2092STRPBF-EL](#)
[IPS70R2K0CEAKMA1](#) [BSF024N03LT3 G](#) [PSMN4R2-30MLD](#) [TK31J60W5,S1VQ\(O](#) [2SK2614\(TE16L1,Q\)](#) [DMN1017UCP3-7](#)
[EFC2J004NUZTDG](#) [P85W28HP2F-7071](#) [DMN1053UCP4-7](#) [SQJ469EP-T1-GE3](#) [NTE2384](#) [NTE6400A](#) [DMC2700UDMQ-7](#)
[DMN2080UCB4-7](#) [DMN61D9UWQ-13](#) [US6M2GTR](#) [DMN31D5UDJ-7](#) [SSM6P54TU,LF](#) [DMP22D4UFO-7B](#) [IPS60R3K4CEAKMA1](#)
[DMN1006UCA6-7](#) [DMN16M9UCA6-7](#) [STF5N65M6](#) [IRF40H233XTMA1](#) [IPSA70R950CEAKMA1](#) [IPSA70R2K0CEAKMA1](#) [STU5N65M6](#)
[C3M0021120D](#) [DMN6022SSD-13](#) [DMN13M9UCA6-7](#) [MCQ4828A-TP](#)