

Features

- Ultra low leakage: nA level
- Operating voltage: 15V
- Low clamping voltage
- Complies with following standards:
 - IEC 61000-4-2 (ESD) immunity test
 - Air discharge: $\pm 30\text{kV}$
 - Contact discharge: $\pm 30\text{kV}$
 - IEC61000-4-4 (EFT) 40A (5/50ns)
 - IEC61000-4-5 (Lightning) 6A (8/20 μs)
- RoHS Compliant

Dimensions DFN1006



Pin Configuration

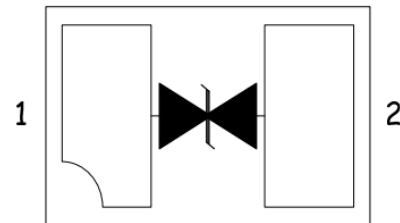

Applications

- USB 2.0 power and data line
- Set-top box and digital TV
- Digital video interface (DVI)
- Notebook Computers
- SIM Ports
- 10/100 Ethernet

Mechanical Characteristics

- Package: DFN1006
- Lead Finish: Lead Free
- UL Flammability Classification Rating 94V-0
- Quantity Per Reel: 10,000pcs
- Reel Size: 7 inch

Absolute Maximum Ratings (Tamb=25°C unless otherwise specified)

Parameter	Symbol	Value	Unit
Peak Pulse Power (8/20 μs)	Ppp	150	W
ESD per IEC 61000-4-2 (Air)	V _{ESD}	± 30	Kv
ESD per IEC 61000-4-2 (Contact)		± 30	
Operating Temperature Range	T _J	-55 to +150	°C
Storage Temperature Range	T _{STJ}	-55 to +150	°C

Electrical Characteristics (TA=25°C unless otherwise specified)

Part Number	Device Marking	V _{RWM} (V)	V _{BR} (V)	I _T (mA)	V _C @1A	V _C		I _R μA (Max)	C (Pf) (Typ.)
						(Max)	(@A)		
SDA1511CDN	15B	15	16.2	1	18	25	6	0.2	5

Typical Performance Characteristics (TA=25°C unless otherwise Specified)

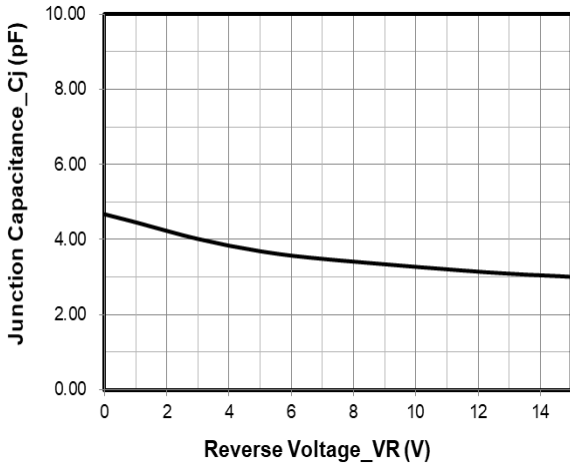

Junction Capacitance vs. Reverse Voltage

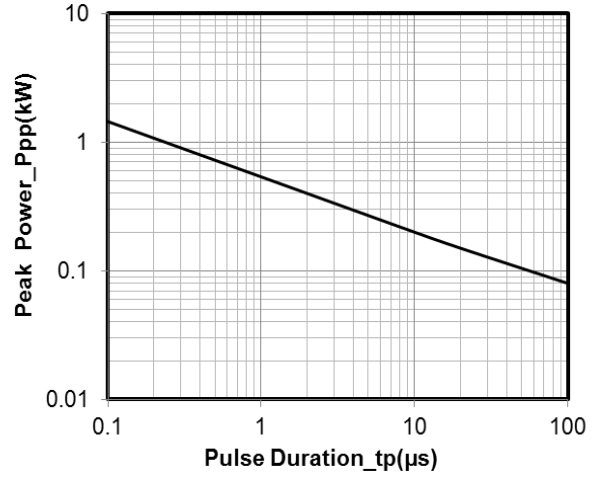

Peak Pulse Power vs. Pulse Time

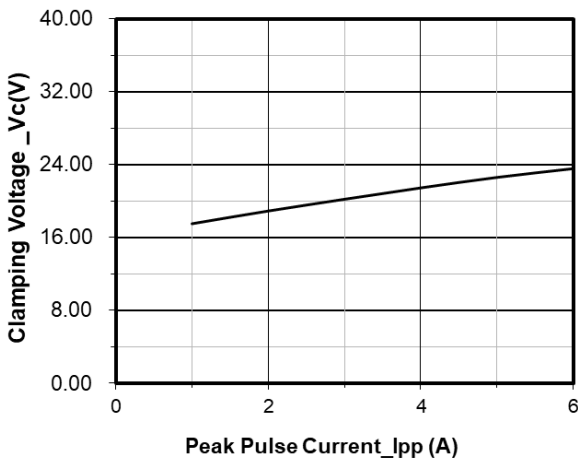

Clamping Voltage vs. Peak Pulse Current

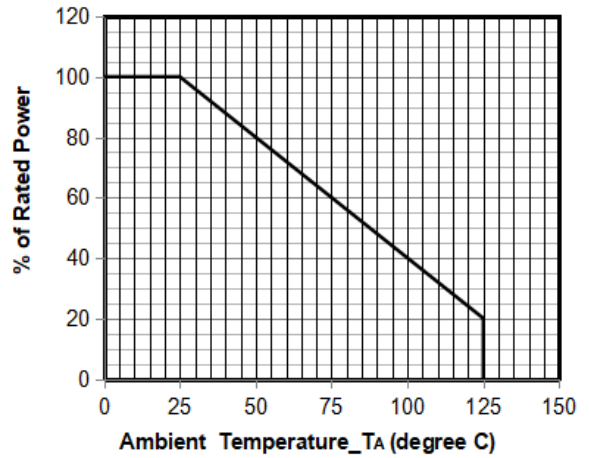

Power Derating Curve

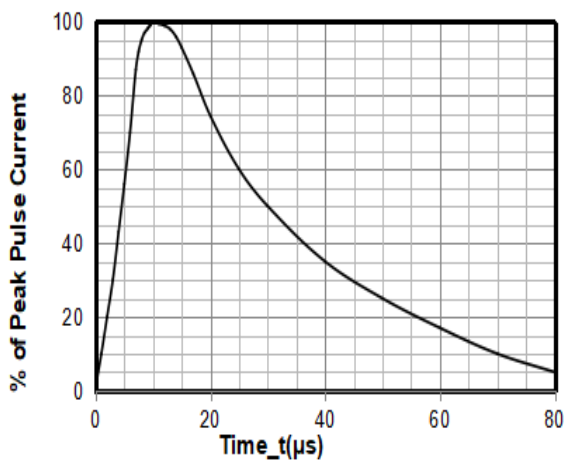

8 X 20μs Pulse Waveform

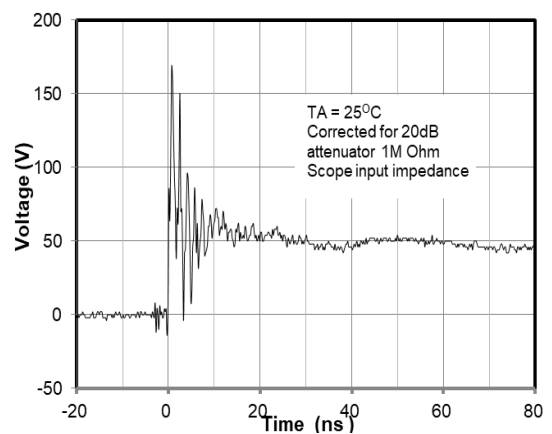

ESD Clamping Voltage
8 kV Contact per IEC61000-4-2

DFN1006 PACKAGE OUTLINE & DIMENSIONS

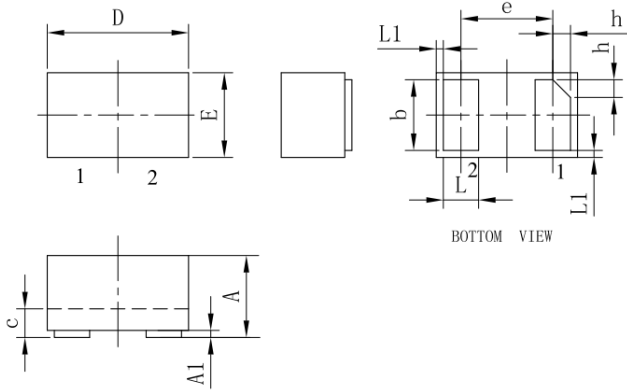

SYM	DIMENSIONS					
	MILLIMETERS			INCHES		
	MIN	NOM	MAX	MIN	NOM	MAX
A	0.45	0.50	0.55	0.018	0.020	0.022
A1	0.00	0.02	0.05	0.000	0.001	0.002
b	0.45	0.50	0.55	0.018	0.020	0.022
c	0.12	0.15	0.18	0.005	0.006	0.007
D	0.95	1.00	1.05	0.037	0.039	0.041
e	0.65 BSC			0.026 BSC		
E	0.55	0.60	0.65	0.022	0.024	0.026
L	0.20	0.25	0.30	0.008	0.010	0.012
L1	0.05REF			0.002REF		
h	0.07	0.12	0.17	0.003	0.005	0.007

Suggested Land Pattern

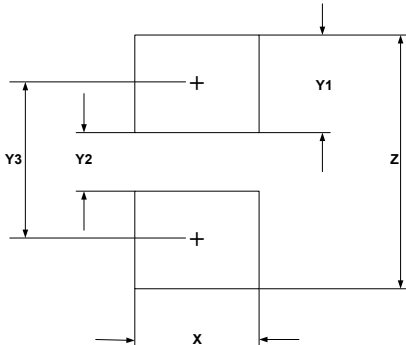

SYM	DIMENSIONS	
	MILLIMETERS	INCHES
X	0.60	0.024
Y1	0.50	0.020
Y2	0.30	0.012
Y3	0.80	0.032
Z	1.30	0.052

X-ON Electronics

Largest Supplier of Electrical and Electronic Components

Click to view similar products for [ESD Suppressors / TVS Diodes](#) category:

Click to view products by [Leiditech](#) manufacturer:

Other Similar products are found below :

[60KS200C](#) [D18V0L1B2LP-7B](#) [D5V0F4U5P5-7](#) [DESD5V0U1BB-7](#) [NTE4902](#) [P4KE27CA](#) [P6KE11CA](#) [P6KE39CA-TP](#) [P6KE8.2A](#)
[SA110CA](#) [SA60CA](#) [SA64CA](#) [SMBJ12CATR](#) [SMBJ33CATR](#) [SMBJ8.0A](#) [ESD101-B1-02ELS E6327](#) [ESD105-B1-02EL E6327](#) [ESD112-B1-02EL E6327](#) [ESD119B1W01005E6327XTSA1](#) [ESD5V0L1B02VH6327XTSA1](#) [ESD7451N2T5G](#) [19180-510](#) [CPDT-5V0USP-HF](#)
[3.0SMCJ33CA-F](#) [3.0SMCJ36A-F](#) [HSPC16701B02TP](#) [D3V3Q1B2DLP3-7](#) [D55V0M1B2WS-7](#) [DESD5V0U1BL-7B](#) [DRTR5V0U4SL-7](#)
[SCM1293A-04SO](#) [ESD200-B1-CSP0201 E6327](#) [SM12-7](#) [SMLJ45CA-TP](#) [CEN955 W/DATA](#) [82350120560](#) [VESD12A1A-HD1-GS08](#)
[CPDUR5V0R-HF](#) [CPDQC5V0U-HF](#) [CPDQC5V0USP-HF](#) [CPDQC5V0-HF](#) [D1213A-01LP4-7B](#) [D1213A-02WL-7](#) [MMAD1108/TR13](#)
[5KP100A](#) [5KP15A](#) [5KP18A](#) [5KP48A](#) [5KP90A](#) [5KP90CA](#)