

Features

- Ultra low leakage: nA level
- Operating voltage: 15V
- Low clamping voltage
- Complies with following standards:
 - IEC 61000-4-2 (ESD) immunity test
 - Air discharge: $\pm 30\text{kV}$
 - Contact discharge: $\pm 30\text{kV}$
 - IEC61000-4-4 (EFT) 40A (5/50ns)
 - IEC61000-4-5 (Lightning) 6A (8/20 μs)
- RoHS Compliant

Dimensions DFN1006



Pin Configuration

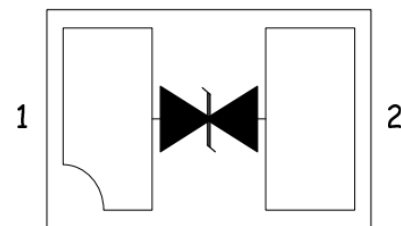

Applications

- USB 2.0 power and data line
- Set-top box and digital TV
- Digital video interface (DVI)
- Notebook Computers
- SIM Ports
- 10/100 Ethernet

Mechanical Characteristics

- Package: DFN1006
- Lead Finish: Lead Free
- UL Flammability Classification Rating 94V-0
- Quantity Per Reel: 10,000pcs
- Reel Size: 7 inch

Absolute Maximum Ratings (T_{amb}=25°C unless otherwise specified)

| Parameter | Symbol | Value | Unit |
|--|------------------|-------------|------|
| Peak Pulse Power (8/20 μs) | P _{pp} | 150 | W |
| ESD per IEC 61000-4-2 (Air) | V _{ESD} | ± 30 | Kv |
| ESD per IEC 61000-4-2 (Contact) | | ± 30 | |
| Operating Temperature Range | T _J | -55 to +150 | °C |
| Storage Temperature Range | T _{STJ} | -55 to +150 | °C |

Electrical Characteristics (TA=25°C unless otherwise specified)

| Part Number | Device Marking | V _{RWM} (V) | V _{BR} (V) | I _T (mA) | V _C @1A | V _C | | I _R μA (Max) | C (Pf) (Typ.) |
|--------------|----------------|-------------------------|------------------------|------------------------|-----------------------|----------------|------|-------------------------------|---------------------|
| | | | | | | (Max) | (@A) | | |
| SPHV15-01KTG | 15B | 15 | 16.2 | 1 | 18 | 25 | 6 | 0.2 | 5 |

Typical Performance Characteristics (TA=25°C unless otherwise Specified)

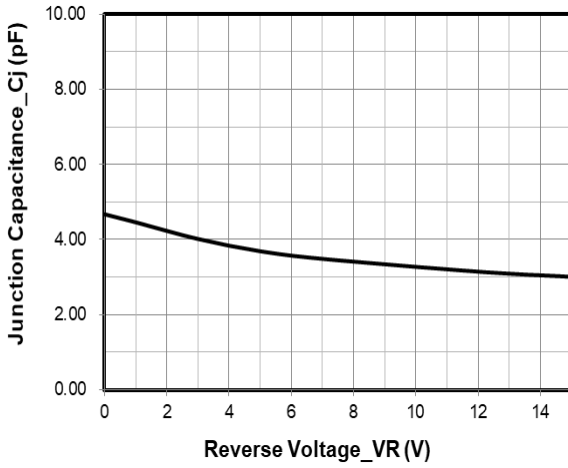

Junction Capacitance vs. Reverse Voltage

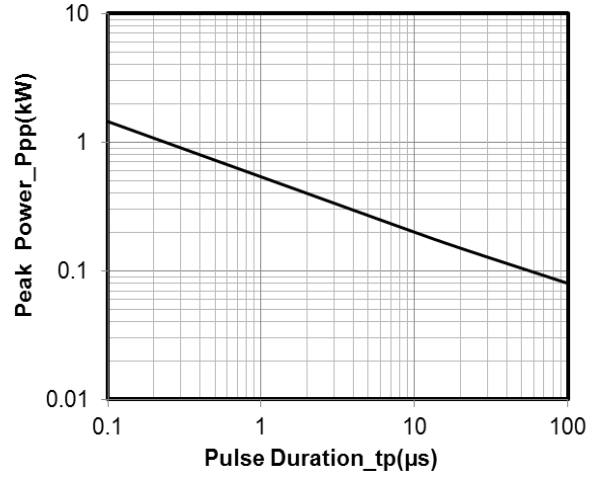

Peak Pulse Power vs. Pulse Time

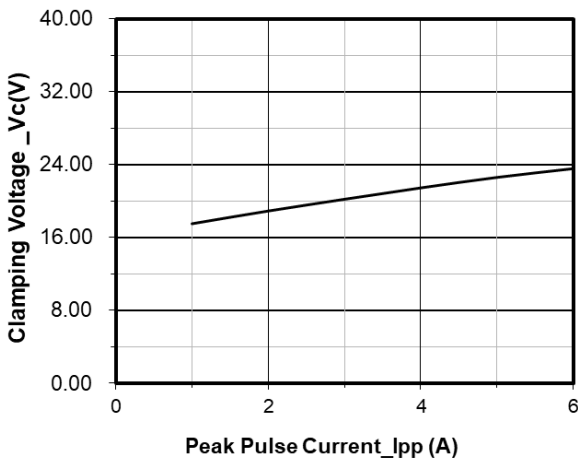

Clamping Voltage vs. Peak Pulse Current

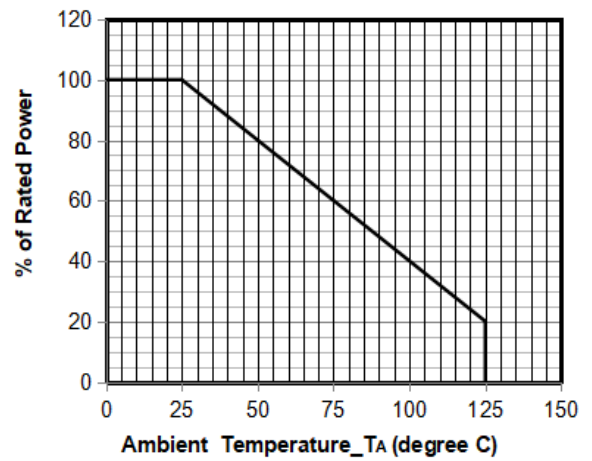

Power Derating Curve

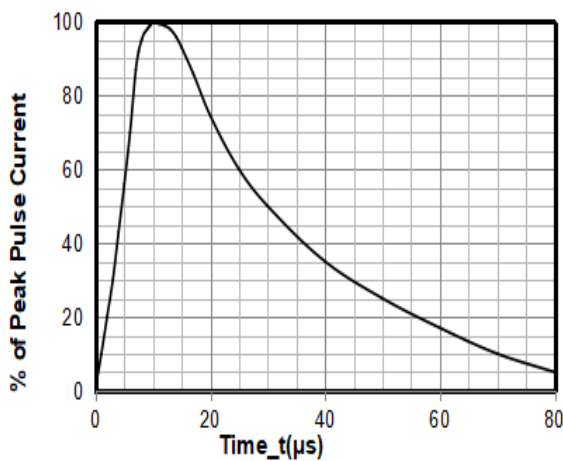

8 X 20μs Pulse Waveform

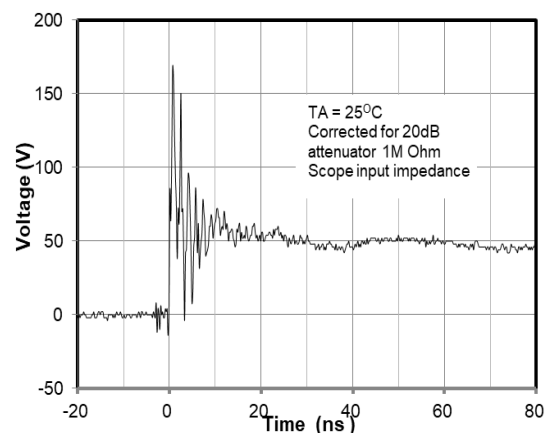

ESD Clamping Voltage
8 kV Contact per IEC61000-4-2

DFN1006 PACKAGE OUTLINE & DIMENSIONS

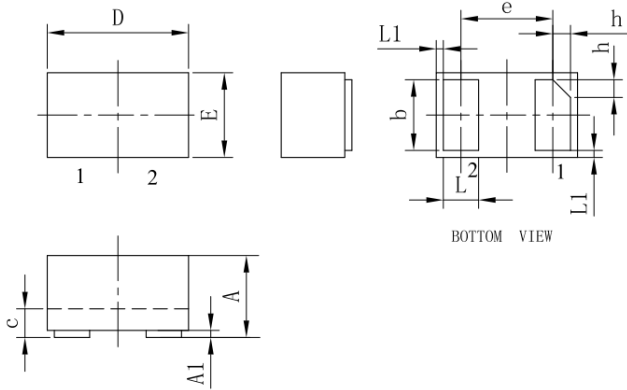

| SYM | DIMENSIONS | | | | | |
|-----|-------------|------|------|-----------|-------|-------|
| | MILLIMETERS | | | INCHES | | |
| | MIN | NOM | MAX | MIN | NOM | MAX |
| A | 0.45 | 0.50 | 0.55 | 0.018 | 0.020 | 0.022 |
| A1 | 0.00 | 0.02 | 0.05 | 0.000 | 0.001 | 0.002 |
| b | 0.45 | 0.50 | 0.55 | 0.018 | 0.020 | 0.022 |
| c | 0.12 | 0.15 | 0.18 | 0.005 | 0.006 | 0.007 |
| D | 0.95 | 1.00 | 1.05 | 0.037 | 0.039 | 0.041 |
| e | 0.65 BSC | | | 0.026 BSC | | |
| E | 0.55 | 0.60 | 0.65 | 0.022 | 0.024 | 0.026 |
| L | 0.20 | 0.25 | 0.30 | 0.008 | 0.010 | 0.012 |
| L1 | 0.05REF | | | 0.002REF | | |
| h | 0.07 | 0.12 | 0.17 | 0.003 | 0.005 | 0.007 |

Suggested Land Pattern

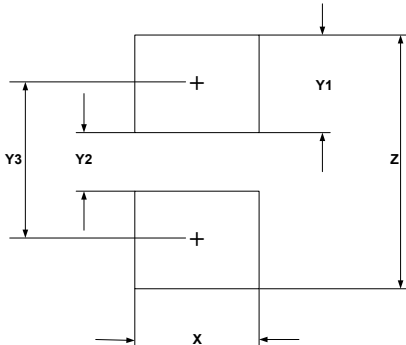

| SYM | DIMENSIONS | |
|-----|-------------|--------|
| | MILLIMETERS | INCHES |
| X | 0.60 | 0.024 |
| Y1 | 0.50 | 0.020 |
| Y2 | 0.30 | 0.012 |
| Y3 | 0.80 | 0.032 |
| Z | 1.30 | 0.052 |

X-ON Electronics

Largest Supplier of Electrical and Electronic Components

Click to view similar products for [ESD Suppressors / TVS Diodes](#) category:

Click to view products by [Leiditech](#) manufacturer:

Other Similar products are found below :

[60KS200C](#) [D18V0L1B2LP-7B](#) [D5V0F4U5P5-7](#) [DESD5V0U1BB-7](#) [NTE4902](#) [P4KE27CA](#) [P6KE11CA](#) [P6KE39CA-TP](#) [P6KE8.2A](#)
[SA110CA](#) [SA60CA](#) [SA64CA](#) [SMBJ12CATR](#) [SMBJ33CATR](#) [SMBJ8.0A](#) [ESD101-B1-02ELS E6327](#) [ESD105-B1-02EL E6327](#) [ESD112-B1-02EL E6327](#) [ESD119B1W01005E6327XTSA1](#) [ESD5V0L1B02VH6327XTSA1](#) [ESD7451N2T5G](#) [19180-510](#) [CPDT-5V0USP-HF](#)
[3.0SMCJ33CA-F](#) [3.0SMCJ36A-F](#) [HSPC16701B02TP](#) [D3V3Q1B2DLP3-7](#) [D55V0M1B2WS-7](#) [DESD5V0U1BL-7B](#) [DRTR5V0U4SL-7](#)
[SCM1293A-04SO](#) [ESD200-B1-CSP0201 E6327](#) [SM12-7](#) [SMLJ45CA-TP](#) [CEN955 W/DATA](#) [82350120560](#) [VESD12A1A-HD1-GS08](#)
[CPDUR5V0R-HF](#) [CPDQC5V0U-HF](#) [CPDQC5V0USP-HF](#) [CPDQC5V0-HF](#) [D1213A-01LP4-7B](#) [D1213A-02WL-7](#) [MMAD1108/TR13](#)
[5KP100A](#) [5KP15A](#) [5KP18A](#) [5KP48A](#) [5KP90A](#) [5KP90CA](#)