

### Description

The STD15P6F6AG uses advanced trench technology to provide excellent  $R_{DS(ON)}$ , low gate charge and operation with gate voltages as low as 4.5V. This device is suitable for use as a Battery protection or in other Switching application.

### General Features

$V_{DS} = -100V$   $I_D = -15A$

$R_{DS(ON)} < 185m\Omega$  @  $V_{GS}=10V$  (Type: 145m $\Omega$ )

### Application

Brushless motor

Load switch

Uninterruptible power supply

### Dimensions TO-252

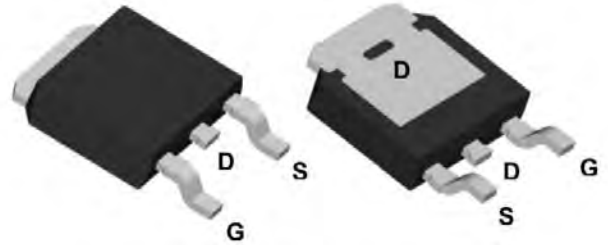

### Pin Configuration

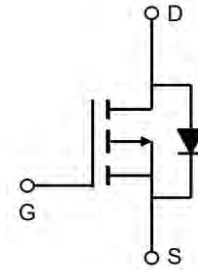

### Package Marking and Ordering Information

Product ID	Pack	Marking	Qty(PCS)
STD15P6F6AG	TO-252	AP15P10D XXX YYYY	2500

### Absolute Maximum Ratings ( $T_C=25^\circ C$ unless otherwise noted)

Symbol	Parameter	Rating	Units
$V_{DS}$	Drain-Source Voltage	-100	V
$V_{GS}$	Gate-Source Voltage	$\pm 20$	V
$I_D@T_C=25^\circ C$	Continuous Drain Current, $V_{GS} @ -10V^1$	-15	A
$I_D@T_C=100^\circ C$	Continuous Drain Current, $V_{GS} @ -10V^1$	-12	A
$I_{DM}$	Pulsed Drain Current <sup>2</sup>	-45	A
EAS	Single Pulse Avalanche Energy <sup>3</sup>	56	mJ
$I_{AS}$	Avalanche Current	-15	A
$P_D@T_C=25^\circ C$	Total Power Dissipation <sup>4</sup>	50	W
$T_{STG}$	Storage Temperature Range	-55 to 150	$^\circ C$
$T_J$	Operating Junction Temperature Range	-55 to 150	$^\circ C$
$R_{\theta JA}$	Thermal Resistance Junction-Ambient <sup>1</sup>	62.5	$^\circ C/W$
$R_{\theta JC}$	Thermal Resistance Junction-Case <sup>1</sup>	2.5	$^\circ C/W$

## P-Channel Electrical Characteristics (T<sub>J</sub> =25 °C, unless otherwise noted)

Symbol	Parameter	Test Condition	Min.	Typ	Max.	Units
BVDSS	Drain-Source Breakdown Voltage	V <sub>GS</sub> = 0V, I <sub>D</sub> = -250μA	-100	-	-	V
IDSS	Zero Gate Voltage Drain Current	V <sub>DS</sub> = -80V, V <sub>GS</sub> = 0V	-	-	1	μA
IGSS	Gate to Body Leakage Current	V <sub>DS</sub> = 0V, V <sub>GS</sub> = ±20V	-	-	±100	nA
VGS(th)	Gate Threshold Voltage	V <sub>DS</sub> = V <sub>GS</sub> , I <sub>D</sub> = -250μA	-1.0	-	-2.5	V
RDS(on)	Static Drain-Source On-Resistance <sup>note1</sup>	V <sub>GS</sub> = -10V, I <sub>D</sub> = -2A	-	145	185	mΩ
		V <sub>GS</sub> = -4.5V, I <sub>D</sub> = -1A	-	170	200	
Ciss	Input Capacitance	V <sub>DS</sub> = -50V, V <sub>GS</sub> = 0V, f = 1.0MHz	-	1545	-	pF
Coss	Output Capacitance		-	37	-	pF
Crss	Reverse Transfer Capacitance		-	25	-	pF
Q <sub>g</sub>	Total Gate Charge	V <sub>DD</sub> = -50V, I <sub>D</sub> = -2A, V <sub>GS</sub> = -10V	-	27	-	nC
Q <sub>gs</sub>	Gate-Source Charge		-	5.3	-	nC
Q <sub>gd</sub>	Gate-Drain("Miller") Charge		-	3.2	-	nC
td(on)	Turn-On Delay Time	V <sub>DS</sub> = -50V, I <sub>D</sub> = -2A R <sub>G</sub> =4.5Ω, R <sub>L</sub> =25Ω V <sub>GEN</sub> = -10 V	-	10	-	ns
t <sub>r</sub>	Turn-On Rise Time		-	27	-	ns
td(off)	Turn-Off Delay Time		-	288	-	ns
t <sub>f</sub>	Turn-Off Fall Time		-	88	-	ns
IS	Maximum Continuous Drain to Source Diode Forward Current		-	-	-18	A
VSD	Drain to Source Diode Forward Voltage <sup>note1</sup>	V <sub>GS</sub> = 0V, I <sub>S</sub> = -2A	-	-	-1.3	V
t <sub>rr</sub>	Reverse Recovery Time	V <sub>GS</sub> = 0V, I <sub>sd</sub> = -6A, di/dt = 100A/μs	-	40	-	nS
Q <sub>rr</sub>	Reverse Recovery Charge		-	28	-	nC

Note :

- 1、 The data tested by surface mounted on a 1 inch 2 FR-4 board with 2OZ copper.
- 2、 The data tested by pulsed , pulse width ≅ 300us , duty cycle ≅ 2%
- 3、 The EAS data shows Max. rating . The test condition is V<sub>DD</sub> = -72V, V<sub>GS</sub> = -10V, L=0.1mH, I<sub>AS</sub> = -15A
- 4、 The power dissipation is limited by 150°C junction temperature
- 5、 The data is theoretically the same as I<sub>D</sub> and I<sub>DM</sub> , in real applications , should be limited by total power dissipation.

## Typical Characteristics

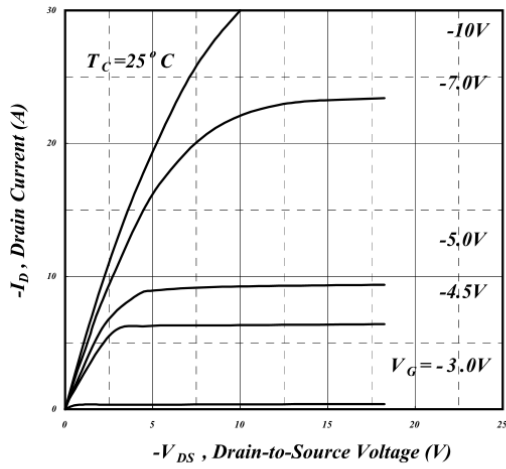

Fig 1. Typical Output Characteristics

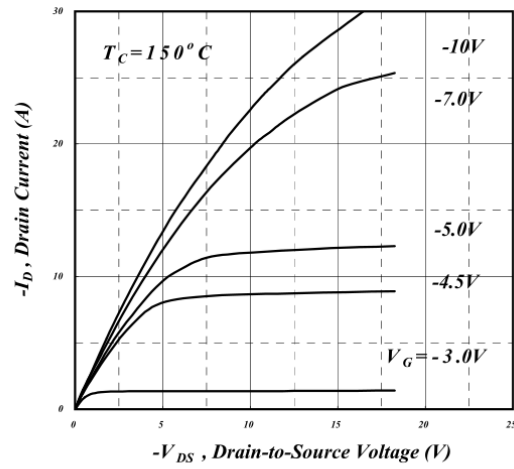

Fig 2. Typical Output Characteristics

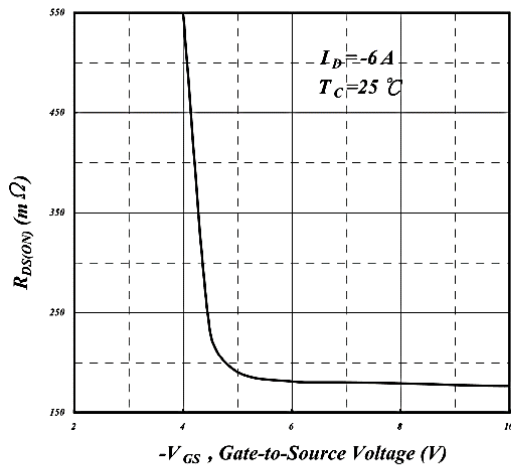

Fig 3. On-Resistance v.s. Gate Voltage

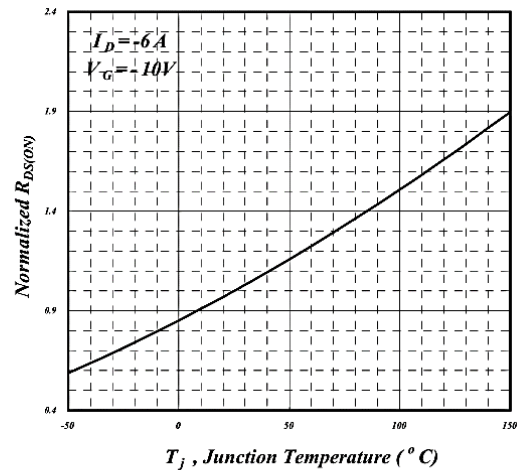

Fig 4. Normalized On-Resistance v.s. Junction Temperature

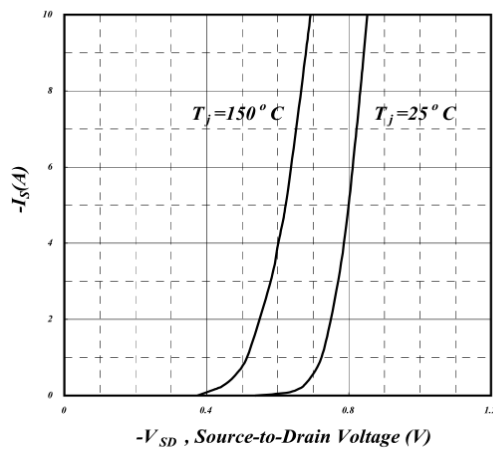

Fig 5. Forward Characteristic of Reverse Diode

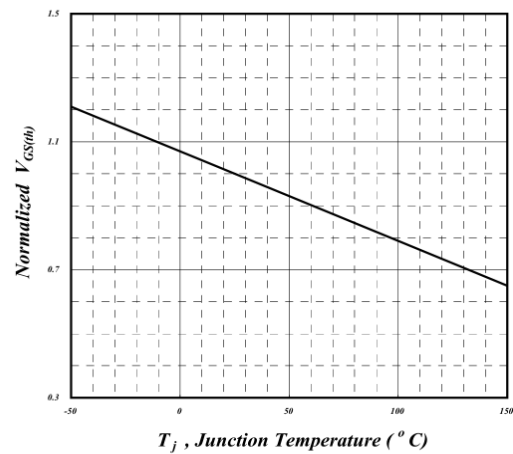

Fig 6. Gate Threshold Voltage v.s. Junction Temperature

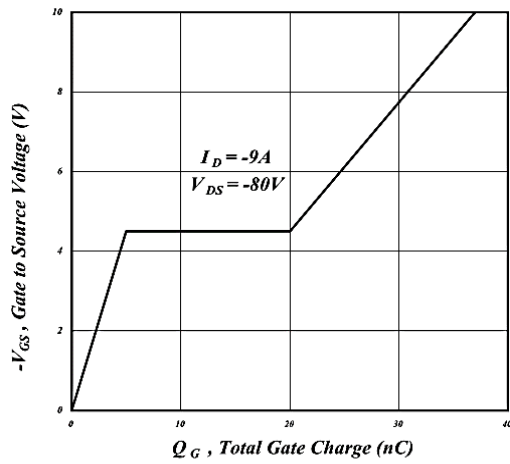

Fig 7. Gate Charge Characteristics

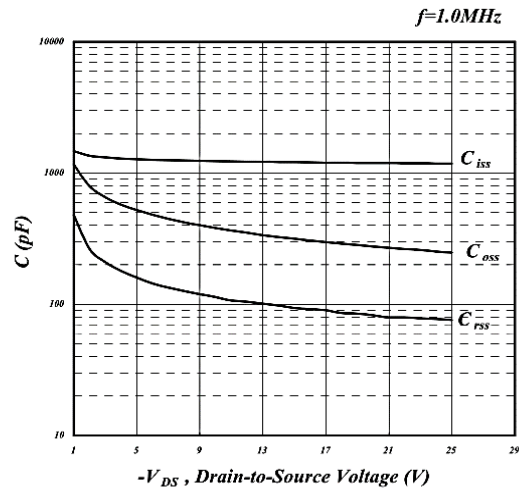

Fig 8. Typical Capacitance Characteristics

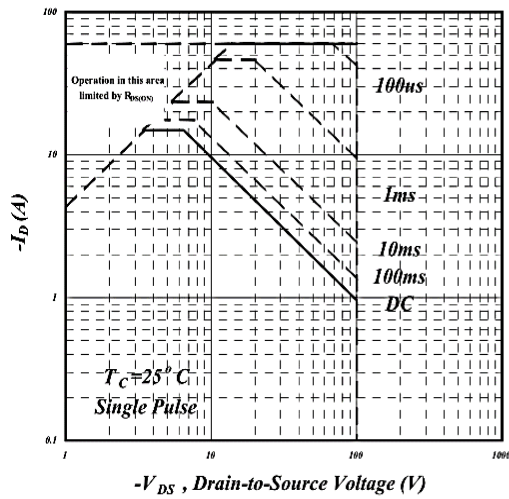

Fig 9. Maximum Safe Operating Area

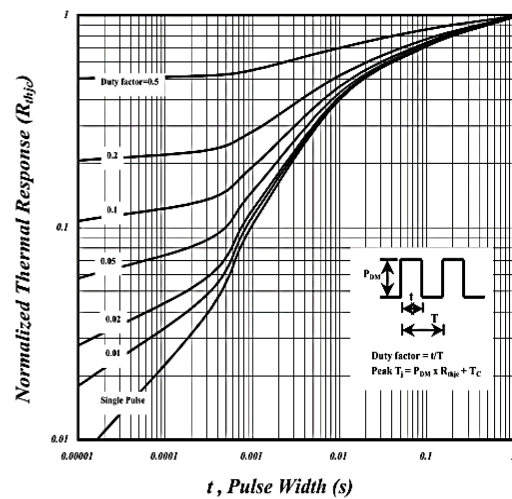

Fig 10. Effective Transient Thermal Impedance

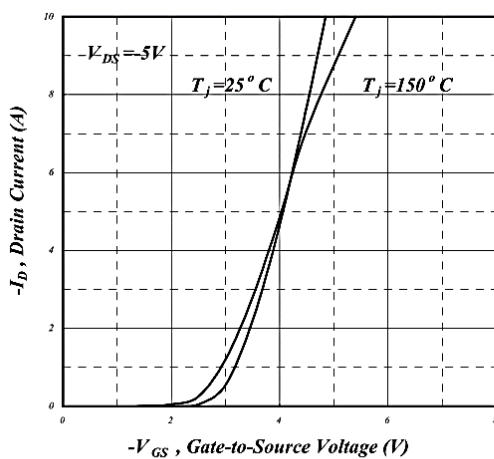

Fig 11. Transfer Characteristics

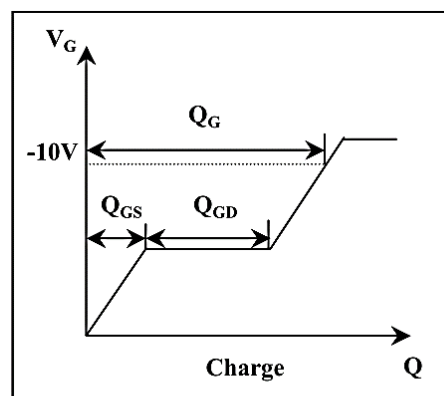
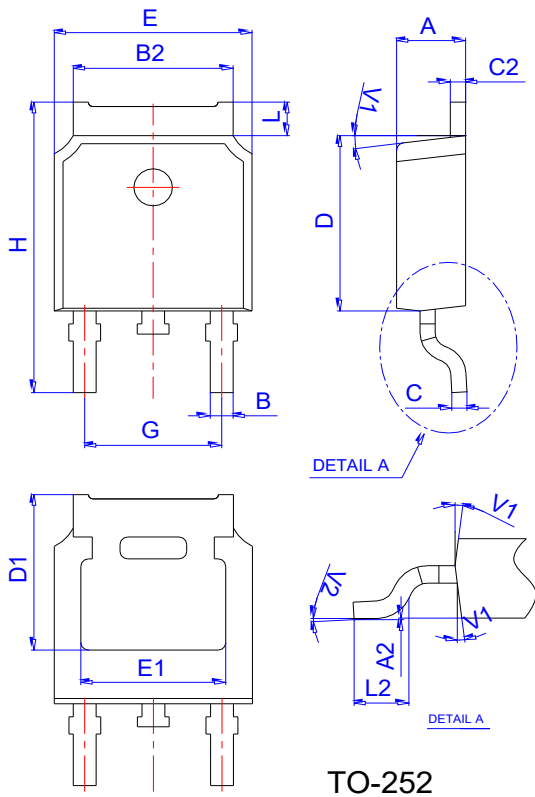

Fig 12. Gate Charge Waveform

## Package Mechanical Data:TO-252-3L



Ref.	Dimensions					
	Millimeters			Inches		
	Min.	Typ.	Max.	Min.	Typ.	Max.
A	2.10		2.50	0.083		0.098
A2	0		0.10	0		0.004
B	0.66		0.86	0.026		0.034
B2	5.18		5.48	0.202		0.216
C	0.40		0.60	0.016		0.024
C2	0.44		0.58	0.017		0.023
D	5.90		6.30	0.232		0.248
D1	5.30REF			0.209REF		
E	6.40		6.80	0.252		0.268
E1	4.63			0.182		
G	4.47		4.67	0.176		0.184
H	9.50		10.70	0.374		0.421
L	1.09		1.21	0.043		0.048
L2	1.35		1.65	0.053		0.065
V1		7°			7°	
V2	0°		6°	0°		6°

## Reel Specification-TO-252

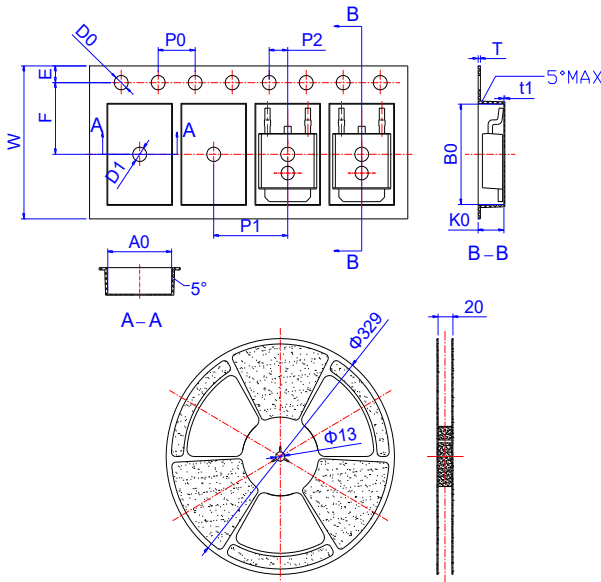

Ref.	Dimensions					
	Millimeters			Inches		
	Min.	Typ.	Max.	Min.	Typ.	Max.
W	15.90	16.00	16.10	0.626	0.630	0.634
E	1.65	1.75	1.85	0.065	0.069	0.073
F	7.40	7.50	7.60	0.291	0.295	0.299
D0	1.40	1.50	1.60	0.055	0.059	0.063
D1	1.40	1.50	1.60	0.055	0.059	0.063
P0	3.90	4.00	4.10	0.154	0.157	0.161
P1	7.90	8.00	8.10	0.311	0.315	0.319
P2	1.90	2.00	2.10	0.075	0.079	0.083
A0	6.85	6.90	7.00	0.270	0.271	0.276
B0	10.45	10.50	10.60	0.411	0.413	0.417
K0	2.68	2.78	2.88	0.105	0.109	0.113
T	0.24		0.27	0.009		0.011
t1	0.10			0.004		
10P0	39.80	40.00	40.20	1.567	1.575	1.583

## X-ON Electronics

Largest Supplier of Electrical and Electronic Components

*Click to view similar products for [MOSFET](#) category:*

*Click to view products by [Leiditech](#) manufacturer:*

Other Similar products are found below :

[MCH3443-TL-E](#) [MCH6422-TL-E](#) [NTNS3A92PZT5G](#) [IRFD120](#) [JANTX2N5237](#) [2N7000](#) [2SK2464-TL-E](#) [2SJ277-DL-E](#) [2SK2267\(Q\)](#)  
[2SK2545\(Q,T\)](#) [405094E](#) [423220D](#) [MIC4420CM-TR](#) [VN1206L](#) [614234A](#) [715780A](#) [SSM6J414TU,LF\(T](#) [751625C](#) [IRS2092STRPBF-EL](#)  
[IPS70R2K0CEAKMA1](#) [BSF024N03LT3 G](#) [PSMN4R2-30MLD](#) [TK31J60W5,S1VQ\(O](#) [2SK2614\(TE16L1,Q\)](#) [DMN1017UCP3-7](#)  
[EFC2J004NUZTDG](#) [P85W28HP2F-7071](#) [DMN1053UCP4-7](#) [SQJ469EP-T1-GE3](#) [NTE2384](#) [NTE6400A](#) [DMC2700UDMQ-7](#)  
[DMN2080UCB4-7](#) [DMN61D9UWQ-13](#) [US6M2GTR](#) [DMN31D5UDJ-7](#) [SSM6P54TU,LF](#) [DMP22D4UFO-7B](#) [IPS60R3K4CEAKMA1](#)  
[DMN1006UCA6-7](#) [DMN16M9UCA6-7](#) [STF5N65M6](#) [IRF40H233XTMA1](#) [IPSA70R950CEAKMA1](#) [IPSA70R2K0CEAKMA1](#) [STU5N65M6](#)  
[C3M0021120D](#) [DMN6022SSD-13](#) [DMN13M9UCA6-7](#) [MCQ4828A-TP](#)