

### Features

- Ultra low capacitance: 0.3pF typical (I/O to I/O)
- Ultra low leakage: nA level
- Operating voltage: 5V
- Low clamping voltage
- Up to 4 data lines and one power line protects
- Complies with following standards:
  - IEC 61000-4-2 (ESD) immunity test
    - Air discharge:  $\pm 25\text{kV}$
    - Contact discharge:  $\pm 20\text{kV}$
  - IEC61000-4-5 (Lightning) 5A (8/20 $\mu\text{s}$ )
- RoHS Compliant

### Applications

- USB 2.0 and USB 3.0 Ports
- USB OTG
- Digital Visual Interface (DVI)
- Monitor and Flat Panel Displays
- PCI Express and Serial SATA Ports
- Gigabit Ethernet
- IEEE 1394 Firewire Ports
- Consumer products (STB, DVD, DSC, DVC)

### Mechanical Characteristics

- Package: SOT-563
- Lead Finish: Lead Free
- UL Flammability Classification Rating 94V-0
- Quantity Per Reel: 4,000pcs
- Reel Size: 7inch

### Dimensions SOT-563

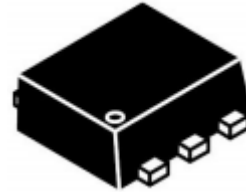

### Pin Configuration

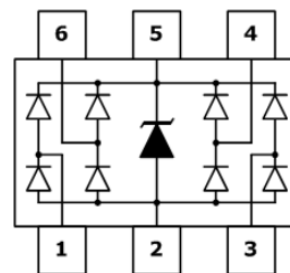

### Absolute Maximum Ratings (Tamb=25°C unless otherwise specified)

| Parameter                              | Symbol           | Value       | Unit |
|--|------------------|-------------|------|
| Peak Pulse Power (8/20 $\mu\text{s}$ ) | Ppp              | 100         | W    |
| ESD per IEC 61000-4-2 (Air)            | V <sub>ESD</sub> | $\pm 25$    | Kv   |
| ESD per IEC 61000-4-2 (Contact)        |                  | $\pm 20$    |      |
| Operating Temperature Range            | T <sub>J</sub>   | -55 to +125 | °C   |
| Storage Temperature Range              | T <sub>STJ</sub> | -55 to +150 | °C   |

## Electrical Characteristics (TA=25°C unless otherwise specified)

| Part Number | Device Marking | V <sub>RWM</sub><br>(V) | V <sub>BR</sub><br>(V) | I <sub>T</sub><br>(mA) | V <sub>C</sub><br>@1A | V <sub>C</sub> |      | I <sub>R</sub><br>μA<br>(Max) | C<br>(Pf)<br>(Typ.) |
|-------------|----------------|-------------------------|------------------------|------------------------|-----------------------|----------------|------|-------------------------------|---------------------|
|             |                |                         |                        |                        |                       | (Max)          | (@A) |                               |                     |
| ULC0504T6   | 5456           | 5                       | 6                      | 1                      | 15                    | 20             | 5    | 0.5                           | 0.7                 |

## Typical Performance Characteristics (T<sub>A</sub>=25°C unless otherwise Specified)

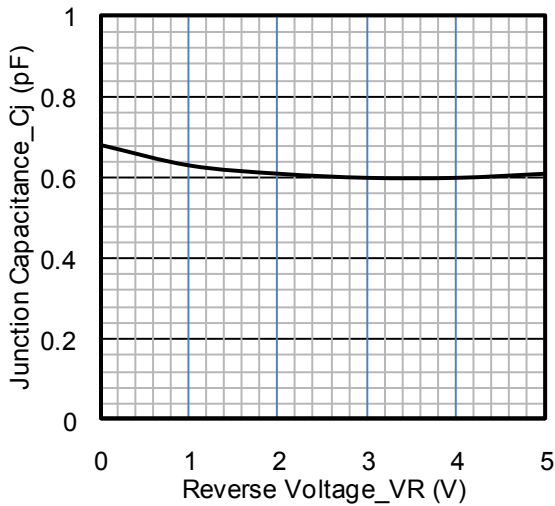

**Junction Capacitance vs. Reverse Voltage**

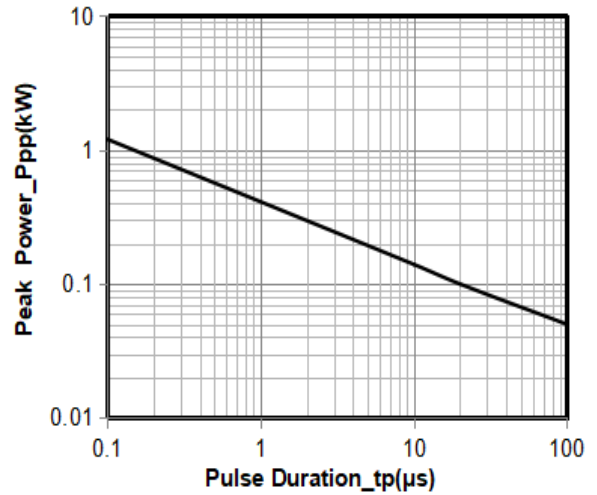

**Peak Pulse Power vs. Pulse Time**

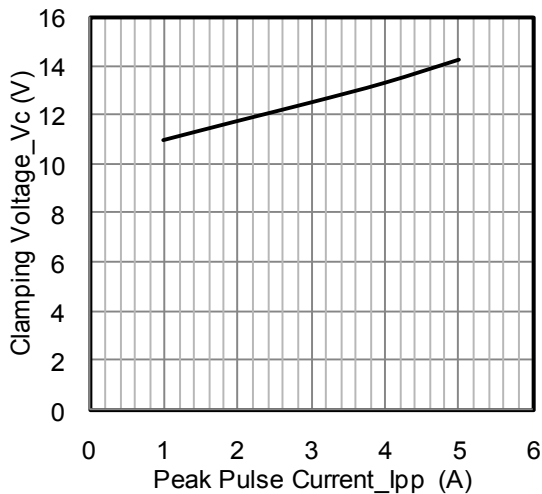

**Clamping Voltage vs. Peak Pulse Current**

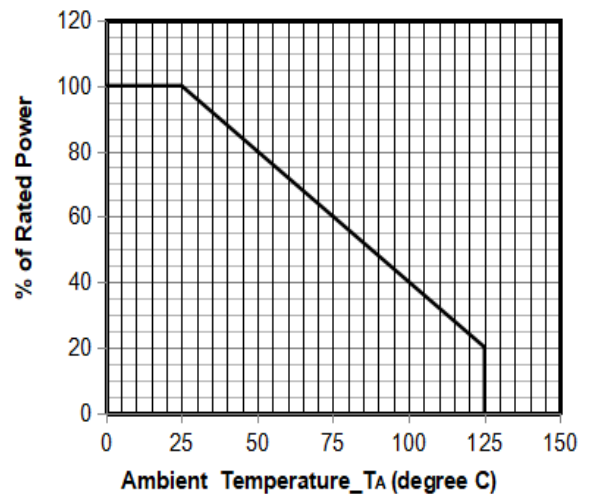

**Power Derating Curve**

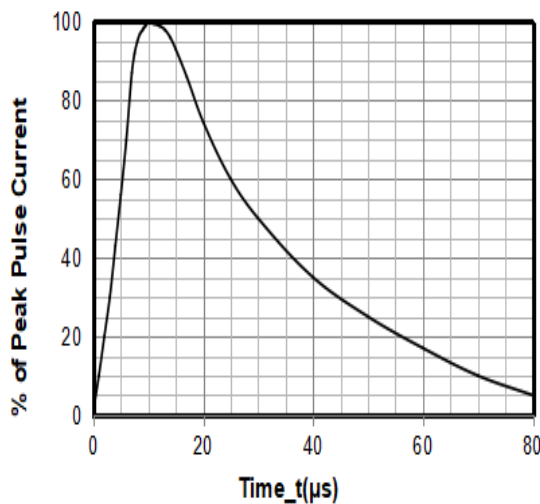

**8 X 20μs Pulse Waveform**

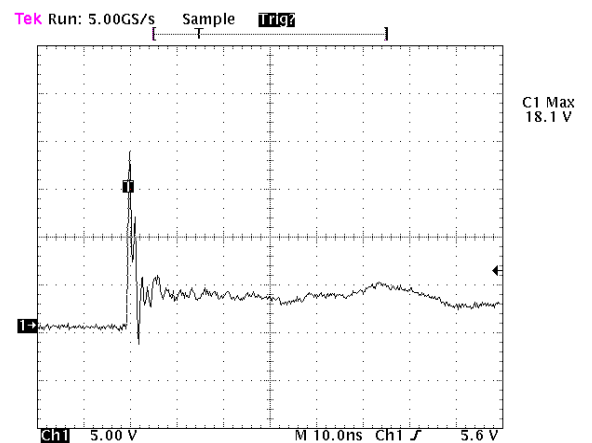

Note: Data is taken with a 10x attenuator

**ESD Clamping Voltage**

**8 kV Contact per IEC61000-4-2**

## SOT-563 Package Outline & Dimensions

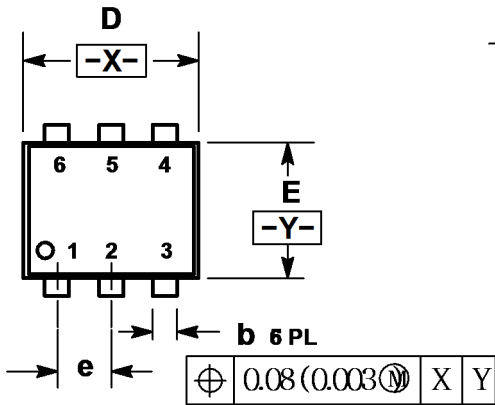

| DIM | MILLIMETERS |      |      | INCHES   |       |       |
|-----|-------------|------|------|----------|-------|-------|
|     | MIN         | NOM  | MAX  | MIN      | NOM   | MAX   |
| A   | 0.50        | 0.55 | 0.60 | 0.020    | 0.021 | 0.023 |
| b   | 0.17        | 0.22 | 0.27 | 0.007    | 0.009 | 0.011 |
| C   | 0.08        | 0.12 | 0.18 | 0.003    | 0.005 | 0.007 |
| D   | 1.50        | 1.60 | 1.70 | 0.059    | 0.062 | 0.066 |
| E   | 1.10        | 1.20 | 1.30 | 0.043    | 0.047 | 0.051 |
| e   | 0.5 BSC     |      |      | 0.02 BSC |       |       |
| L   | 0.10        | 0.20 | 0.30 | 0.004    | 0.008 | 0.012 |
| HE  | 1.50        | 1.60 | 1.70 | 0.059    | 0.062 | 0.066 |

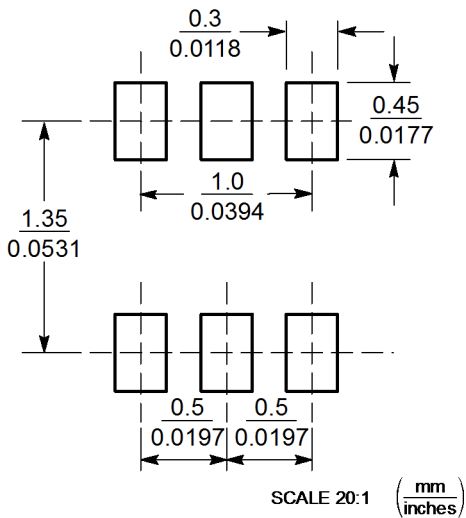

## X-ON Electronics

Largest Supplier of Electrical and Electronic Components

*Click to view similar products for [ESD Suppressors / TVS Diodes](#) category:*

*Click to view products by [Leiditech](#) manufacturer:*

Other Similar products are found below :

[60KS200C](#) [D18V0L1B2LP-7B](#) [D5V0F4U5P5-7](#) [NTE4902](#) [P4KE27CA](#) [P6KE11CA](#) [P6KE8.2A](#) [SA60CA](#) [SA64CA](#) [SMBJ12CATR](#)  
[SMBJ33CATR](#) [SMBJ6.5A](#) [SMBJ8.0A](#) [ESD101-B1-02ELS](#) [E6327](#) [ESD112-B1-02EL](#) [E6327](#) [ESD7451N2T5G](#) [19180-510](#) [CPDT-5V0USP-](#)  
[HF](#) [3.0SMCJ33CA-F](#) [3.0SMCJ36A-F](#) [HSPC16701B02TP](#) [JANTX1N6126A](#) [D3V3Q1B2DLP3-7](#) [D55V0M1B2WS-7](#) [SCM1293A-04SO](#)  
[ESD200-B1-CSP0201](#) [E6327](#) [SM12-7](#) [CEN955](#) [W/DATA](#) [VESD12A1A-HD1-GS08](#) [CPDQC5V0-HF](#) [D1213A-01LP4-7B](#) [ESD101-B1-02EL](#)  
[E6327](#) [AOZ8808DI-03](#) [5KP15A](#) [5KP48A](#) [5KP90A](#) [ESD3V3D7-TP](#) [15KPA36A-LF](#) [P4KE56CA](#) [P4KE68A](#) [P4KE91CATR](#) [P6KE120A](#)  
[P6KE13CA](#) [P6KE43CA](#) [P6KE6.8CA](#) [P6KE8.2](#) [P6SMBJ20CA](#) [JANTX1N6072A](#) [SR2835ESKG](#) [SA90CA](#)