

## ULTRA LOW CAPACITANCE TVS DIODE ARRAY

### Features

- 200 Watts Peak Pulse Power per Line ( $t_p=8/20\mu s$ )
- Protects Up To Two Bidirectional I/O Lines
- Low Capacitance (0.4pF) For High-Speed Interfaces
- Working Voltages : 3.3V
- Ultra-small Package Requires Less Than 2.0x1.0mm of PCB area
- IEC61000-4-2 (ESD)  $\pm 30kV$  (air),  $\pm 30kV$  (contact)
- IEC61000-4-4 (EFT) 40A (5/50ns)
- IEC61000-4-5 (LIGHTNING) 13A (8/20 $\mu s$ )

### Applications

- 10/100/1000 Ethernet
- Integrated magnetics/RJ-45 connectors
- LAN/WAN Equipment
- Security Cameras
- Industrial Controls
- Peripherals
- Notebooks & Desktop Computers

### Dimensions DFN2010T8

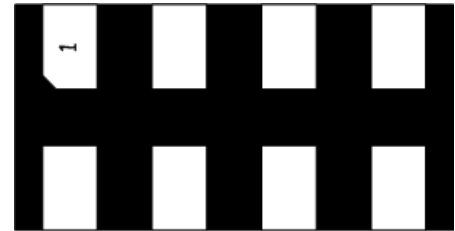

### Pin Configuration

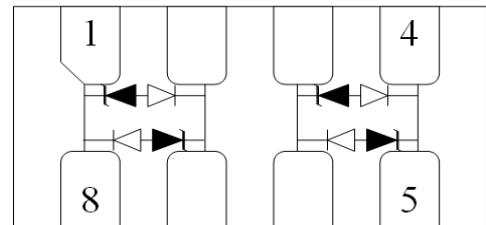

### Mechanical Characteristics

- DFN 2.0x1.0mm Package
- Molding Compound Flammability Rating : UL 94V-O
- Weight 1 Milligrams (Approximate)
- Quantity Per Reel : 3,000pcs
- Reel Size : 7 inch
- Lead Finish : Lead Free

### Absolute Maximum Ratings (T<sub>amb</sub>=25°C unless otherwise specified)

Parameter	Symbol	Value	Unit
Peak Pulse Power (8/20 $\mu s$ )	P <sub>pp</sub>	200	W
ESD per IEC 61000-4-2 (Air)	V <sub>ESD</sub>	$\pm 30$	Kv
ESD per IEC 61000-4-2 (Contact)		$\pm 30$	
Operating Temperature Range	T <sub>J</sub>	-55 to +125	°C
Storage Temperature Range	T <sub>STJ</sub>	-55 to +150	°C

## Electrical Characteristics (TA=25°C unless otherwise specified)

Part Number	Device Marking	V <sub>RWM</sub> (V)	V <sub>BR</sub> (V)	I <sub>T</sub> (mA)	V <sub>C</sub> @1A	V <sub>C</sub>		I <sub>R</sub> μA (Max)	C (Pf) (Typ.)
						(Max)	(@A)		
ULC332010T8	U33	3	3.5	1	7	17	13	0.1	0.6

◆ Note 1 -- I<sub>R</sub> : <0.1uA, T<sub>C</sub> = 25°C, I<sub>R</sub> : <1.0uA, T<sub>C</sub> = 125°C

◆ Note 2 -- 0.6pF (max.), V<sub>R</sub>=2.5V, f=1MHz.

## TYPIC CHARACTERISTICS

### 8x20 $\mu$ s Pulse Waveform

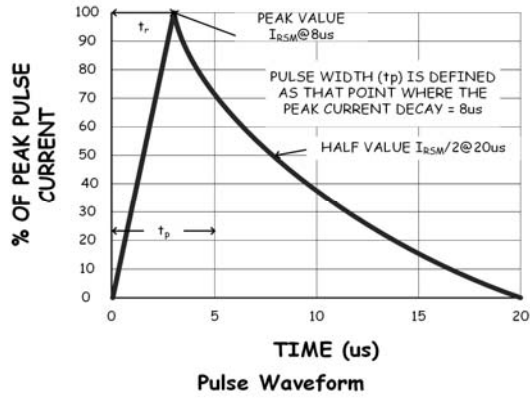

### Power Derating Curve

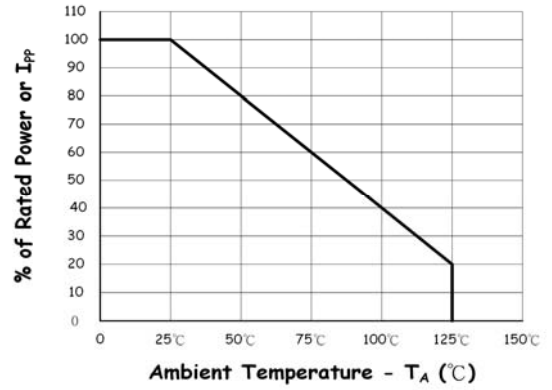

### Clamping Voltage vs. Peak Pulse Current ( $t_p=8/20\mu s$ )

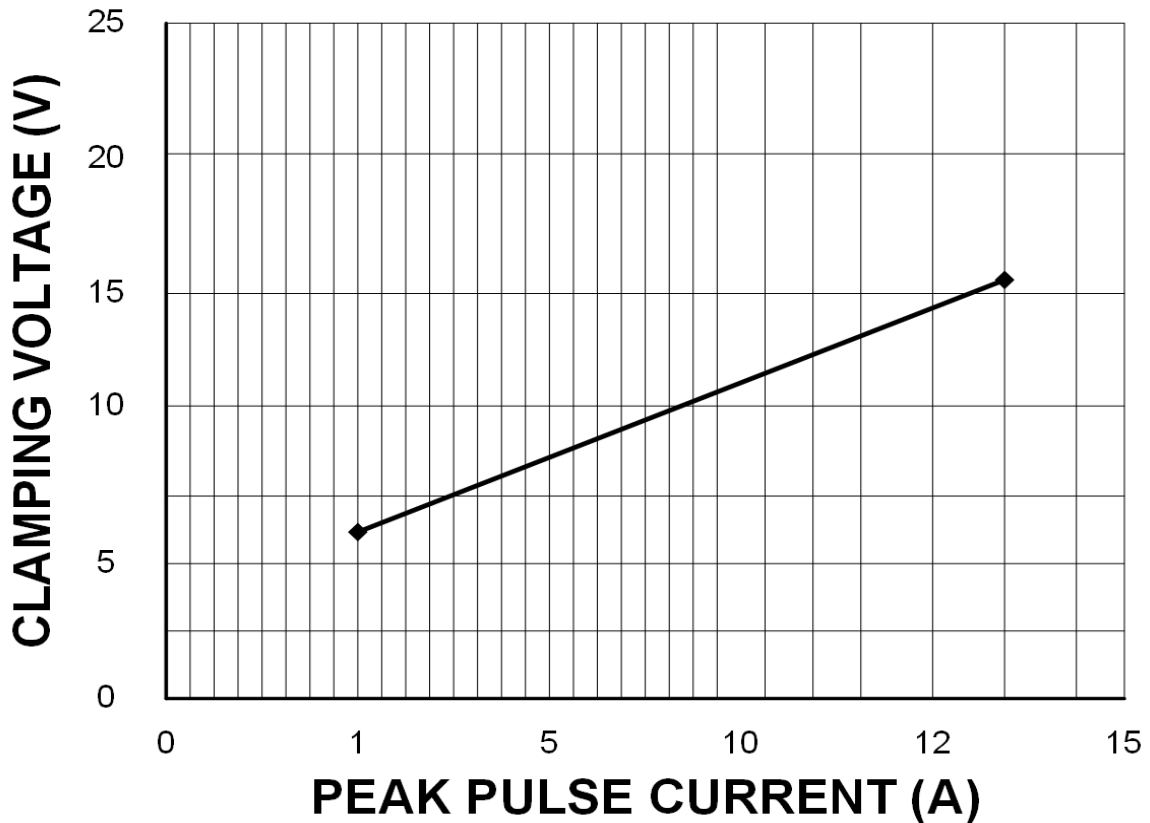

## TYPIC CHARACTERISTICS

### Typic Capacitance vs. Reverse Voltage

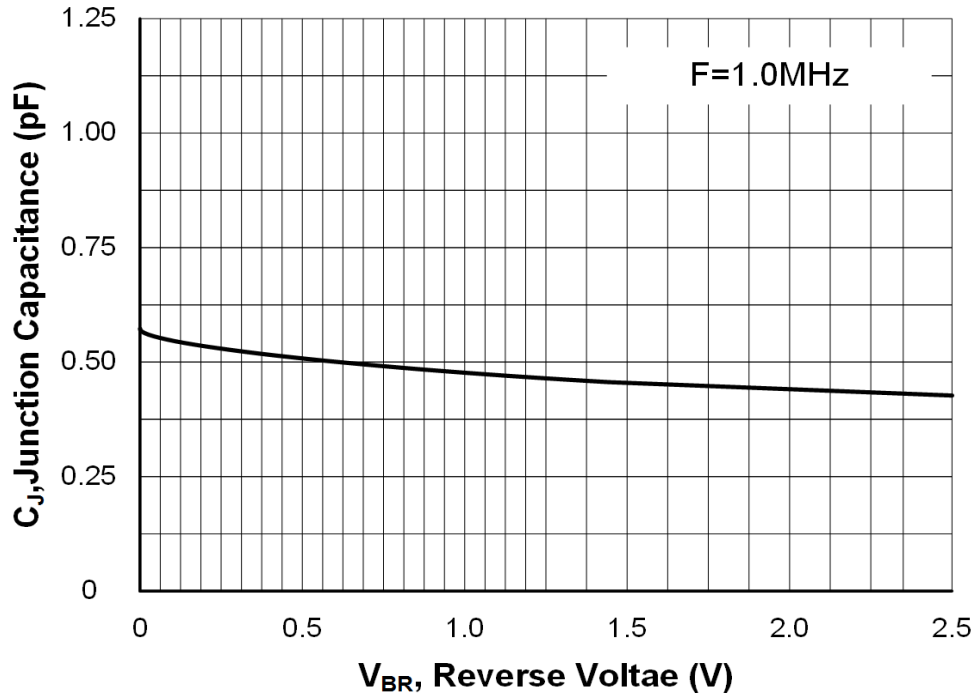

### Typic Reverse Leakage vs. Temperature

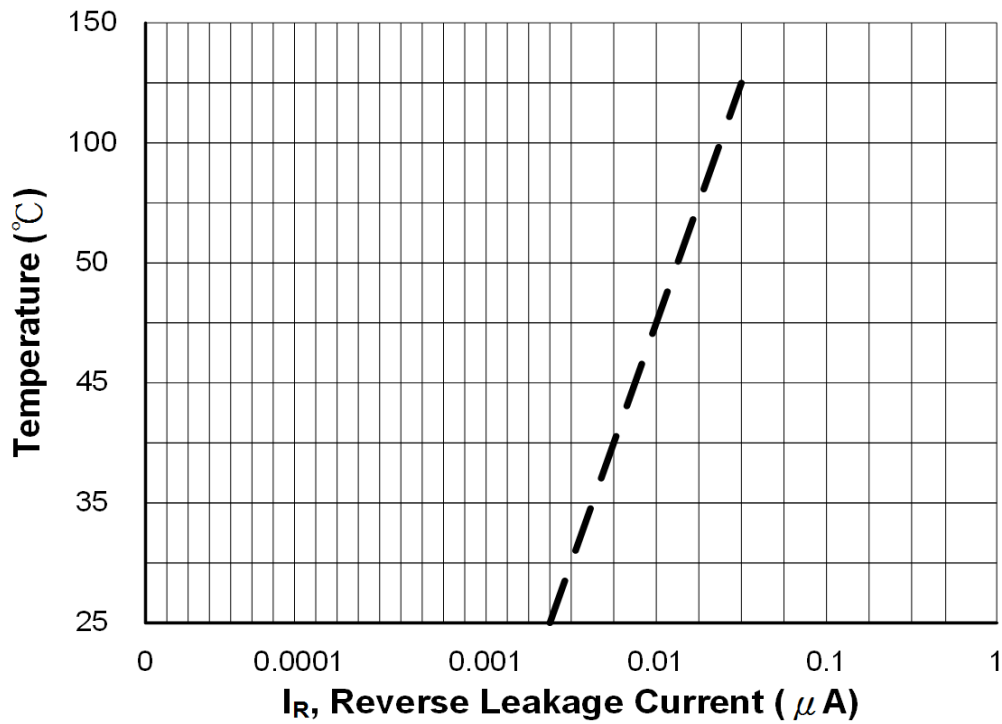

## TYPIC CHARACTERISTICS

Typic Reverse Breakdown Voltage vs. Temperature

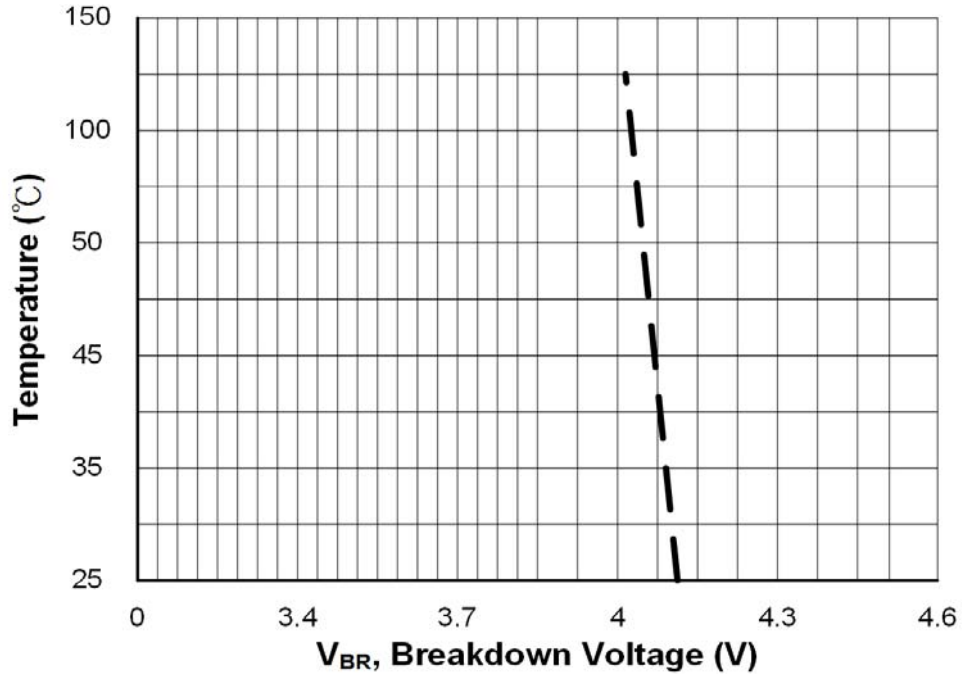

TLP Characterizations (Transmission Line Pulse)

### TLP Characteristic

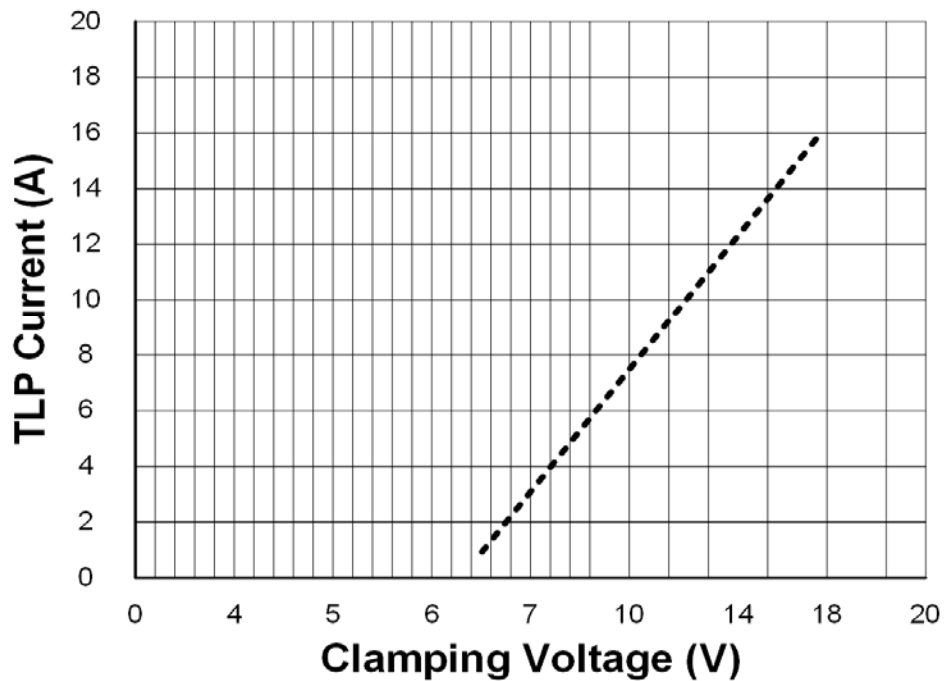

## APPLICATION NOTES

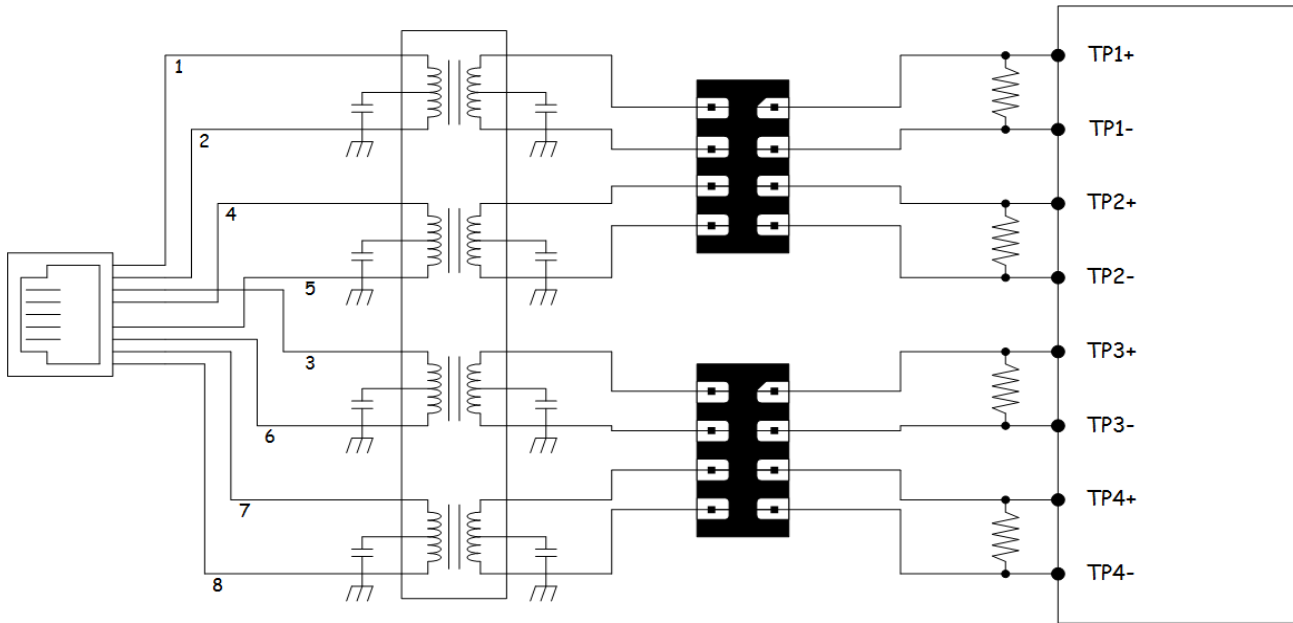

I/O to I/O Schematic Diagram for Gigabit Ethernet Protection

## DFN2010T8 PACKAGE OUTLINE & DIMENSIONS

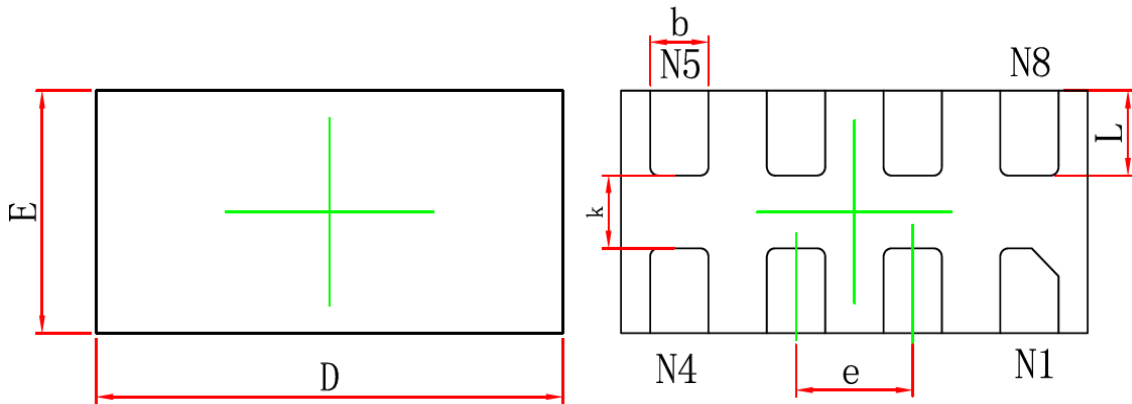

TOP VIEW

BOTTOM VIEW

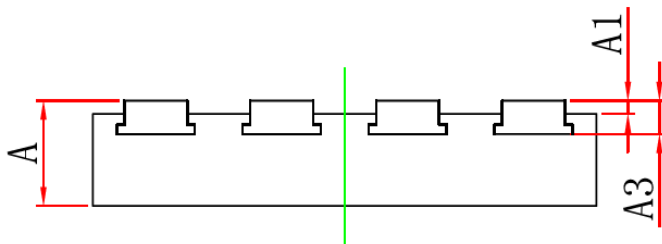

SIDE VIEW

Symbol	Dimensions In Millimeters		Dimensions In Inches	
	Min.	Max.	Min.	Max.
A	0.320	0.400	0.013	0.016
A1	-0.004	0.046	0.000	0.002
A3	0.110REF.		0.004REF.	
D	1.900	2.100	0.075	0.083
E	0.900	1.100	0.035	0.043
k	0.300REF		0.012REF	
b	0.200	0.300	0.008	0.012
e	0.500TYP.		0.020TYP.	
L	0.274	0.426	0.011	0.017

## X-ON Electronics

Largest Supplier of Electrical and Electronic Components

*Click to view similar products for [ESD Suppressors / TVS Diodes](#) category:*

*Click to view products by [Leiditech](#) manufacturer:*

Other Similar products are found below :

[NTE4902](#) [P4SMAJ15A](#) [P4SMAJ26A](#) [SMAJ400CA-TP](#) [TGL34-47CA](#) [ESDAULC45-1BF4](#) [SM1605E3/TR13](#) [SMF20A-TP](#) [P4SMAJ12A](#)  
[CPDUR24V-HF](#) [CPDQC5V0USP-HF](#) [CPDQC5V0-HF](#) [MPLAD30KP280A](#) [MPLAD30KP45CAE3](#) [MMBZ27VCLQ-7-F](#) [MMAD1108/TR13](#)  
[MPLAD30KP24A](#) [MPLAD30KP30CAE3](#) [ACPDQC5V0R-HF](#) [DFLT170A-7](#) [NTE4900](#) [NTE4926](#) [NTE4938](#) [JANTX1N6144A](#)  
[JANTX1N6057A](#) [SMF22A-TP](#) [SMF12A-TP](#) [SLVU2.8-TP](#) [SMLJ6.5CA-TP](#) [SMAJ6.5CA-TP](#) [MMAD1108E3/TR13](#) [JANTX1N6160A](#)  
[D5V0M1U2LP3-7](#) [SMAJ400A-TP](#) [AOZ8811DT-03](#) [AOZ8831DI-05](#) [AOZ8831DT-03](#) [SMAJ188CA](#) [3SMC33CA BK](#) [CPDQC3V3C-HF](#)  
[CPDQC12VE-HF](#) [GRPADATAJANTX1N6041A](#) [MPLAD30KP170CA](#) [82357120100](#) [5.0SMLJ15CA-TP](#) [5KP18A-TP](#) [P6KE8.2A-TP](#)  
[MPLAD30KP43CAE3](#) [SMAJ43A-TP](#) [D26V0H1U2LP16-7](#)