

SUMMARY



Image is for illustrative purpose only

Wires

Low voltage 30

Series 3B
Termination type Female solder
IP rating 50
AWG wire size 30.00 - 22.00
Cable Ø 0.00 - 0.00 mm
Status active
Matching parts [FGA.3B.330.CLAD12](#)

Download

[Request a quote](#)
[Catalog](#)

TECHNICAL DETAILS

Mechanics

Shell Style/Model EC*: Fixed receptacle with two nuts (back panel mounting)
Keying 2 keys (alpha=30, plug: male contacts, receptacle: female contacts)
Housing Material Brass (chrome plated [SAE AMS 2460]) shell and collet nut, nickel plated [SAE AMS QQ N 290] brass latch sleeve and mid pieces
Weight 32.12 g

Performance

Configuration 3B.330 : 30 Low Voltage
Insulator L: PEEK (UL 94 / V-0/1.5)
Rated Current 3.5 Amps

Specifications

Contact Type: Solder
Contact Dia.: 0.7 mm (0.028in)
Bucket Dia.: 0.8 mm (0.031in)
Max. Solid Conductor: 0.34 mm² (AWG 22)
Max. Stranded Conductor: 0.34 mm² (AWG 22)
R (max): 6.1 mOhm
Vtest (contact-shell): 700 V (AC), 990 V (DC)
Vtest (contact-contact): 800 V (AC), 1130 V (DC)

LEMO products and services are provided "as is". LEMO makes no warranties or representations with regard to LEMO product & services or use of them, express, implied or statutory, including for accuracy, completeness, or security. The user is fully responsible for his products and applications using LEMO components.

Others

Endurance (Shell): 5000
Temp (min / max): -55° C / +250° C
Humidity (max): <=95% [at 60 deg C /140 F]
Vibration: 15 g [10 Hz - 2000 Hz]
Shock Resistance: 100 g [6 ms]
Climatical Category: 50/175/21
Shielding (min): 75 dB (10 MHz)
Shielding (min): 40 dB (1 GHz)
Salt Spray Corrosion: >1000 hr

DRAWINGS

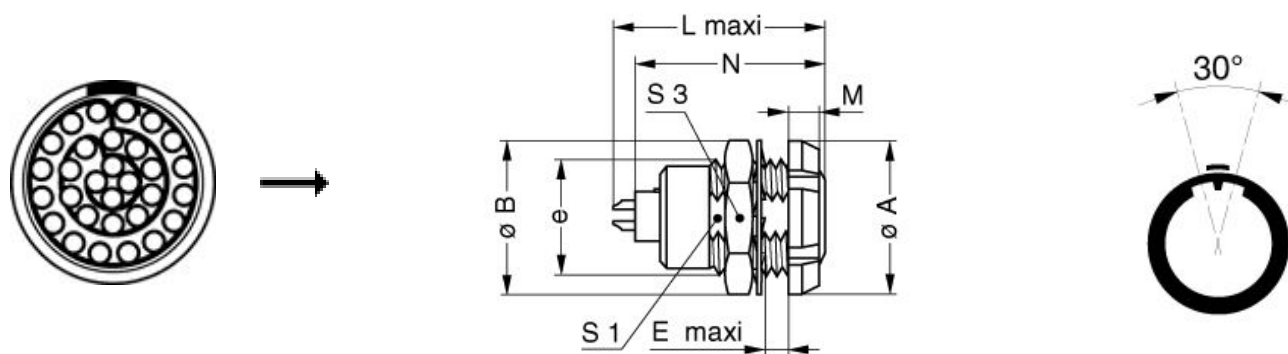

Dimensions







	A	B	E	L	M	N	S1	S3	e
mm.	24	25	9	30.7	4.5	28.1	16.5	22	M18x1.0
in.	0,94	0,98	0,35	1,21	0,18	1,11	0,65	0,87	

RECOMMENDED BY LEMO

Tools

LEMO products and services are provided "as is". LEMO makes no warranties or representations with regard to LEMO product & services or use of them, express, implied or statutory, including for accuracy, completeness, or security. The user is fully responsible for his products and applications using LEMO components.

Cables

CMN.30.T22.087PGCE	PVC	GREY	
CMN.30.T22.087PGZE		Grey	
CMN.30.T22.087PNCE	PVC	Black	
CMN.30.T22.087PNZE			
330240	PVC	Black	
330260	PVC	Black	
430250	PVC	Grey	

LEMO products and services are provided "as is". LEMO makes no warranties or representations with regard to LEMO product & services or use of them, express, implied or statutory, including for accuracy, completeness, or security. The user is fully responsible for his products and applications using LEMO components.

X-ON Electronics

Largest Supplier of Electrical and Electronic Components

Click to view similar products for [Circular Push Pull Connectors](#) category:

Click to view products by [LEMO](#) manufacturer:

Other Similar products are found below :

[6407-249V-11273P](#) [6408-201V-13273](#) [6408-202V-13343](#) [6408-202V-17343](#) [EZG.0B.309.CLN](#) [FFA.2S.310.ZLA](#) [FGA.1B.307.CYCD72Z](#)
[FGJ.1B.304.CLLD76](#) [FGJ.1B.306.CWLD72](#) [FGJ.3B.304.CYMD10Z](#) [FGJ.3B.304.CYMD82Z](#) [PCS.01.250.DLLE24](#) [PHG.0K.305.CYMC40Z](#)
[PHG.1K.308.CLLK85](#) [PKG.M0.6BL.LZ](#) [PLC.M1.0SL.LA](#) [GMA.10.290.DN](#) [GMA.3B.090.DA](#) [PRG.M0.6GL.LC52GZ](#) [PSA.1S.275.CTLC66](#)
[ABF.1S.250.NTA](#) [133020F](#) [1331ER193MZ](#) [1332M107MZ](#) [DTS26Z19-32JA-LC](#) [DTS26Z19-32SA](#) [DTS26Z19-32SA-LC](#) [DTS26Z23-55HA](#)
[DTS26Z23-55HA-LC](#) [DTS26Z23-55JA-LC](#) [EAJ.1B.306.CWA](#) [ECG.XB.312.CLL](#) [1589430-2](#) [EEA.0B.305.CLN](#) [EEA.0B.309.CLL](#)
[ELF.00.250.NTL](#) [ERA.01.250.DLL](#) [BRR.2S.200.PZVG](#) [HR10A-P](#) [CAH.M34.SLL.C72GZ](#) [CAJ.M34.SLL.C72GZ](#) [300500](#) [ESB.00.303.NLL](#)
[EXG.0B.309.HLN](#) [FFB.1S.250.CLAC27](#) [FGA.2B.306.CYCD92](#) [FGA.2B.306.CYCD92Z](#) [FGA.XB.312.CLAD72](#) [FGJ.1B.302.CYMD62](#)
[FGJ.3B.308.CLLD72Z](#)