

SUMMARY



Image is for illustrative purpose only

Wires

Low voltage 4

Series	1B
Termination type	Male crimp
IP rating	50
AWG wire size	24.00 - 20.00
Cable Ø	0.00 - 0.00 mm
Status	active
Matching parts	FGJ.1B.304.CYMD42

Download

[Request a quote](#)

[Catalog](#)

TECHNICAL DETAILS

Mechanics

Shell Style/Model	EC*: Fixed receptacle with two nuts (back panel mounting)
Keying	2 keys (gamma=45, plug: female contacts, receptacle: male contacts)
Housing Material	Brass (chrome plated [SAE AMS 2460]) shell and collet nut, nickel plated [SAE AMS QQ N 290] brass latch sleeve and mid pieces
Weight	11.26 g

Performance

Configuration	1B.304 : 4 Low Voltage
Insulator	Y: PEEK for crimp contacts
Rated Current	10 Amps

Specifications

Contact Type:	Crimp
Contact Retention:	30 N
Contact Dia.:	0.9 mm (0.035in)
Bucket Dia.:	1.1 mm (0.043in)
Min. Conductor:	0.25 mm ² (AWG 24)
Max. Conductor:	0.5 mm ² (AWG 20)
R (max):	4.8 mOhm
Vtest (contact-shell):	1800 V (AC), 2550 V (DC)

LEMO products and services are provided "as is". LEMO makes no warranties or representations with regard to LEMO product & services or use of them, express, implied or statutory, including for accuracy, completeness, or security. The user is fully responsible for his products and applications using LEMO components.

Vtest (contact-contact): 1700 V (AC), 2400 V (DC)

Others

Endurance (Shell): 5000
Temp (min / max): -55°C / +250°C
Humidity (max): ≤95% [at 60 deg C / 140 F]
Vibration: 15 g [10 Hz - 2000 Hz]
Shock Resistance: 100 g [6 ms]
Climatical Category: 50/175/21
Shielding (min): 75 dB (10 MHz)
Shielding (min): 40 dB (1 GHz)
Salt Spray Corrosion: >1000 hr

DRAWINGS

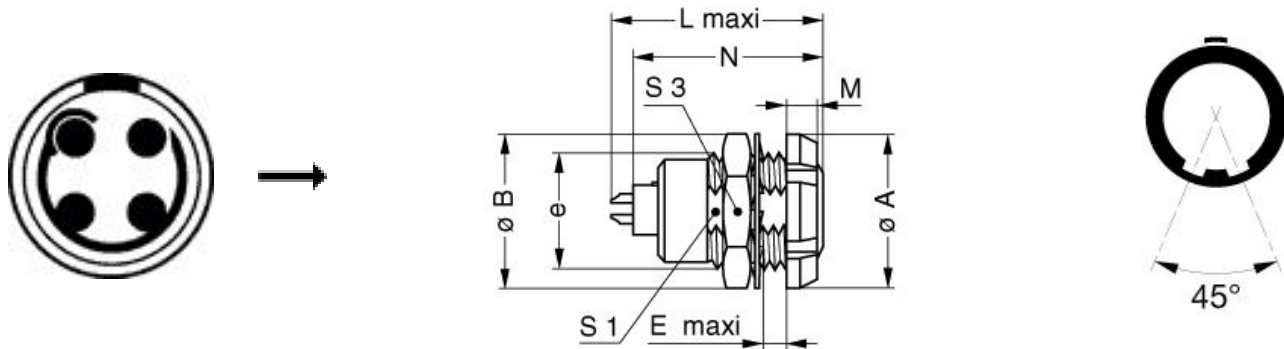

Dimensions

	A	B	E	L	M	N	S1	S3	e
mm.	16	15.8	6	23	3.5	21.1	10.5	14	M12x1.0
in.	0,63	0,62	0,24	0,91	0,14	0,83	0,41	0,55	























RECOMMENDED BY LEMO

Tools

LEMO products and services are provided "as is". LEMO makes no warranties or representations with regard to LEMO product & services or use of them, express, implied or statutory, including for accuracy, completeness, or security. The user is fully responsible for his products and applications using LEMO components.

Crimp Tool: [DPC.91.701.V](#)
 Crimp settings: AWG/Selector = 20-22-24/6-5-5
 Positionner: [DCE.91.091.BVC](#)
 Extractor: [DCF.91.090.2LT](#)
 Spanner 2: [DCH.91.161.PA](#)
 Replacement contact: FGG.1B.560.ZZC

Cables

CMN.04.T20.053PGZE		Grey	
CMN.04.T20.053PNZE			
CMN.04.T20.053QGZE	TPR (medical)	Grey	
CMN.04.T22.047QGC	TPR	Grey	
CMN.04.T22.048QGZE	TPR (medical)	Grey	
CMN.04.T28.031PGCE	PVC	GREY	
CMN.04.T28.031PGZE		Grey	
CMN.04.T28.031PNCE	PVC	Black	
CMN.04.T28.031PNZE			
CMN.04.T28.031QGC	TPR	Grey	
140240	PVC	Black	
140250	PVC	Grey	
240500	PVC	Grey	
240750	PVC	Grey	
40080	PVC	Black	
40086	PVC	Blue	
40140	PVC	Black	
40240	PTFE	White	
40260	PVC	Black	
4041	PVC	Grey	
4050	PVC	Black	
4080	PVC	Grey	
417920	PVC	Grey	
4220	PVC	Black	
4221	PVC	Black	
4260	PTFE	White	
4280	PVC	Black	
80080	PVC	Grey	
80082	PVC	Red	
80084	PVC	Black	

LEMO products and services are provided "as is". LEMO makes no warranties or representations with regard to LEMO product & services or use of them, express, implied or statutory, including for accuracy, completeness, or security. The user is fully responsible for his products and applications using LEMO components.

CTR.75.030.121870G	PVC	Grey	
--------------------	-----	------	---

LEMO products and services are provided "as is". LEMO makes no warranties or representations with regard to LEMO product & services or use of them, express, implied or statutory, including for accuracy, completeness, or security. The user is fully responsible for his products and applications using LEMO components.

X-ON Electronics

Largest Supplier of Electrical and Electronic Components

Click to view similar products for [Circular Push Pull Connectors](#) category:

Click to view products by [LEMO](#) manufacturer:

Other Similar products are found below :

[6407-249V-11273P](#) [6408-201V-13273](#) [6408-202V-13343](#) [6408-202V-17343](#) [EZG.0B.309.CLN](#) [FFA.2S.310.ZLA](#) [FGA.1B.307.CYCD72Z](#)
[FGJ.1B.304.CLLD76](#) [FGJ.1B.306.CWLD72](#) [FGJ.3B.304.CYMD10Z](#) [FGJ.3B.304.CYMD82Z](#) [PCS.01.250.DLLE24](#) [PHG.0K.305.CYMC40Z](#)
[PHG.1K.308.CLLK85](#) [PKG.M0.6BL.LZ](#) [PLC.M1.0SL.LA](#) [GMA.10.290.DN](#) [GMA.3B.090.DA](#) [PRG.M0.6GL.LC52GZ](#) [PSA.1S.275.CTLC66](#)
[ABF.1S.250.NTA](#) [133020F](#) [1331ER193MZ](#) [1332M107MZ](#) [DTS26Z19-32JA-LC](#) [DTS26Z19-32SA](#) [DTS26Z19-32SA-LC](#) [DTS26Z23-55HA](#)
[DTS26Z23-55HA-LC](#) [DTS26Z23-55JA-LC](#) [EAJ.1B.306.CWA](#) [ECG.XB.312.CLL](#) [1589430-2](#) [EEA.0B.305.CLN](#) [EEA.0B.309.CLL](#)
[ELF.00.250.NTL](#) [ERA.01.250.DLL](#) [BRR.2S.200.PZVG](#) [HR10A-P](#) [CAH.M34.SLL.C72GZ](#) [CAJ.M34.SLL.C72GZ](#) [300500](#) [ESB.00.303.NLL](#)
[EXG.0B.309.HLN](#) [FFB.1S.250.CLAC27](#) [FGA.2B.306.CYCD92](#) [FGA.2B.306.CYCD92Z](#) [FGA.XB.312.CLAD72](#) [FGJ.1B.302.CYMD62](#)
[FGJ.3B.308.CLLD72Z](#)