

SUMMARY



Image is for illustrative purpose only

Wires

Low voltage 7

Series	2B
Termination type	Male crimp
IP rating	50
AWG wire size	26.00 - 22.00
Cable Ø	0.00 - 0.00 mm
Status	active
Matching parts	FGJ.2B.307.CYUD82

Download

[Request a quote](#)

[Eplan](#)

[Catalog](#)

TECHNICAL DETAILS

Mechanics

Shell Style/Model	EC*: Fixed receptacle with two nuts (back panel mounting)
Keying	2 keys (alpha=37.5, plug: female contacts, receptacle: male contacts)
Housing Material	Brass (chrome plated [SAE AMS 2460]) shell and collet nut, nickel plated [SAE AMS QQ N 290] brass latch sleeve and mid pieces
Weight	16.15 g

Performance

Configuration	2B.307 : 7 Low Voltage
Insulator	Y: PEEK for crimp contacts
Rated Current	11 Amps

Specifications

Contact Type: Crimp
Contact Retention: 40 N
Contact Dia.: 1.3 mm (0.051in)
Bucket Dia.: 0.8 mm (0.031in)
Min. Conductor: 0.14 mm² (AWG 26)
Max. Conductor: 0.34 mm² (AWG 22)
R (max): 3.6 mOhm
Vtest (contact-shell): 2150 V (AC), 3040 V (DC)

LEMO products and services are provided "as is". LEMO makes no warranties or representations with regard to LEMO product & services or use of them, express, implied or statutory, including for accuracy, completeness, or security. The user is fully responsible for his products and applications using LEMO components.

Vtest (contact-contact): 1950 V (AC), 2750 V (DC)

Others

Endurance (Shell): 5000
Temp (min / max): -55°C / +250°C
Humidity (max): ≤95% [at 60 deg C / 140 F]
Vibration: 15 g [10 Hz - 2000 Hz]
Shock Resistance: 100 g [6 ms]
Climatical Category: 50/175/21
Shielding (min): 75 dB (10 MHz)
Shielding (min): 40 dB (1 GHz)
Salt Spray Corrosion: >1000 hr

DRAWINGS

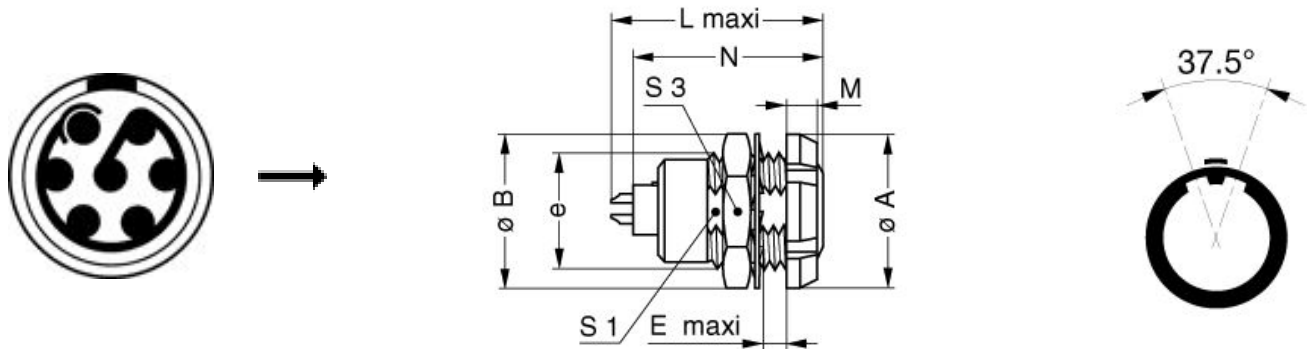

Dimensions

	A	B	E	L	M	N	S1	S3	e
mm.	20	19.2	6.5	26.7	3.5	24.6	13.5	17	M15x1.0
in.	0,79	0,76	0,26	1,05	0,14	0,97	0,53	0,67	









RECOMMENDED BY LEMO

Tools

LEMO products and services are provided "as is". LEMO makes no warranties or representations with regard to LEMO product & services or use of them, express, implied or statutory, including for accuracy, completeness, or security. The user is fully responsible for his products and applications using LEMO components.

Crimp Tool: [DPC.91.701.V](#)
 Crimp settings: AWG/Selector = 22-24-26/6-5-5
 Positionner: [DCE.91.132.CVC](#)
 Extractor: [DCF.91.131.2LT](#)
 Spanner 2: [DCH.91.201.PA](#)
 Replacement contact: FGG.2B.567.ZZC

Cables

CMN.07.T26.037QGZE	TPR (medical)	Grey	
CMN.07.T28.044PGZE		Grey	
CMN.07.T28.044PNZE			
270250	PVC	Grey	
70140	PVC	Grey	
7041	PVC	Grey	
7050	PVC	Black	
717920	PVC	Grey	
CTR.75.030.121875G	PVC	Grey	

LEMO products and services are provided "as is". LEMO makes no warranties or representations with regard to LEMO product & services or use of them, express, implied or statutory, including for accuracy, completeness, or security. The user is fully responsible for his products and applications using LEMO components.

X-ON Electronics

Largest Supplier of Electrical and Electronic Components

Click to view similar products for [Circular Push Pull Connectors](#) category:

Click to view products by [LEMO](#) manufacturer:

Other Similar products are found below :

[6407-249V-11273P](#) [6408-201V-13273](#) [6408-202V-13343](#) [6408-202V-17343](#) [EZG.0B.309.CLN](#) [FFA.2S.310.ZLA](#) [FGA.1B.307.CYCD72Z](#)
[FGJ.1B.304.CLLD76](#) [FGJ.1B.306.CWLD72](#) [FGJ.3B.304.CYMD10Z](#) [FGJ.3B.304.CYMD82Z](#) [PCS.01.250.DLLE24](#) [PHG.0K.305.CYMC40Z](#)
[PHG.1K.308.CLLK85](#) [PKG.M0.6BL.LZ](#) [PLC.M1.0SL.LA](#) [GMA.10.290.DN](#) [GMA.3B.090.DA](#) [PRG.M0.6GL.LC52GZ](#) [PSA.1S.275.CTLC66](#)
[ABF.1S.250.NTA](#) [133020F](#) [1331ER193MZ](#) [1332M107MZ](#) [DTS26Z19-32JA-LC](#) [DTS26Z19-32SA](#) [DTS26Z19-32SA-LC](#) [DTS26Z23-55HA](#)
[DTS26Z23-55HA-LC](#) [DTS26Z23-55JA-LC](#) [EAJ.1B.306.CWA](#) [ECG.XB.312.CLL](#) [1589430-2](#) [EEA.0B.305.CLN](#) [EEA.0B.309.CLL](#)
[ELF.00.250.NTL](#) [ERA.01.250.DLL](#) [BRR.2S.200.PZVG](#) [HR10A-P](#) [CAH.M34.SLL.C72GZ](#) [CAJ.M34.SLL.C72GZ](#) [300500](#) [ESB.00.303.NLL](#)
[EXG.0B.309.HLN](#) [FFB.1S.250.CLAC27](#) [FGA.2B.306.CYCD92](#) [FGA.2B.306.CYCD92Z](#) [FGA.XB.312.CLAD72](#) [FGJ.1B.302.CYMD62](#)
[FGJ.3B.308.CLLD72Z](#)