

## SUMMARY



Image is for illustrative purpose only

### # Wires

Low voltage 12

Series 3B  
Termination type Male crimp  
IP rating 50  
AWG wire size 26.00 - 22.00  
Cable Ø 0.00 - 0.00 mm  
Status active  
Matching parts [FGJ.3B.312.CYPD82](#)

### Download

[Request a quote](#)  
[Eplan](#)  
[Catalog](#)

## TECHNICAL DETAILS

### Mechanics

Shell Style/Model EC\*: Fixed receptacle with two nuts (back panel mounting)  
Keying 2 keys (alpha=37.5, plug: female contacts, receptacle: male contacts)  
Housing Material Brass (chrome plated [SAE AMS 2460]) shell and collet nut, nickel plated [SAE AMS QQ N 290] brass latch sleeve and mid pieces  
Weight 28.06 g

### Performance

Configuration 3B.312 : 12 Low Voltage  
Insulator Y: PEEK for crimp contacts  
Rated Current 9 Amps

### Specifications

Contact Type: Crimp  
Contact Retention: 30 N  
Contact Dia.: 0.9 mm (0.035in)  
Bucket Dia.: 0.8 mm (0.031in)  
Min. Conductor: 0.14 mm<sup>2</sup> (AWG 26)  
Max. Conductor: 0.34 mm<sup>2</sup> (AWG 22)  
R (max): 4.8 mOhm  
Vtest (contact-shell): 1850 V (AC), 2600 V (DC)

LEMO products and services are provided "as is". LEMO makes no warranties or representations with regard to LEMO product & services or use of them, express, implied or statutory, including for accuracy, completeness, or security. The user is fully responsible for his products and applications using LEMO components.

Vtest (contact-contact): 1650 V (AC), 2350 V (DC)

## Others

Endurance (Shell): 5000  
Temp (min / max): -55°C / +250°C  
Humidity (max): ≤95% [at 60 deg C / 140 F]  
Vibration: 15 g [10 Hz - 2000 Hz]  
Shock Resistance: 100 g [ 6 ms]  
Climatical Category: 50/175/21  
Shielding (min): 75 dB (10 MHz)  
Shielding (min): 40 dB (1 GHz)  
Salt Spray Corrosion: >1000 hr

## DRAWINGS

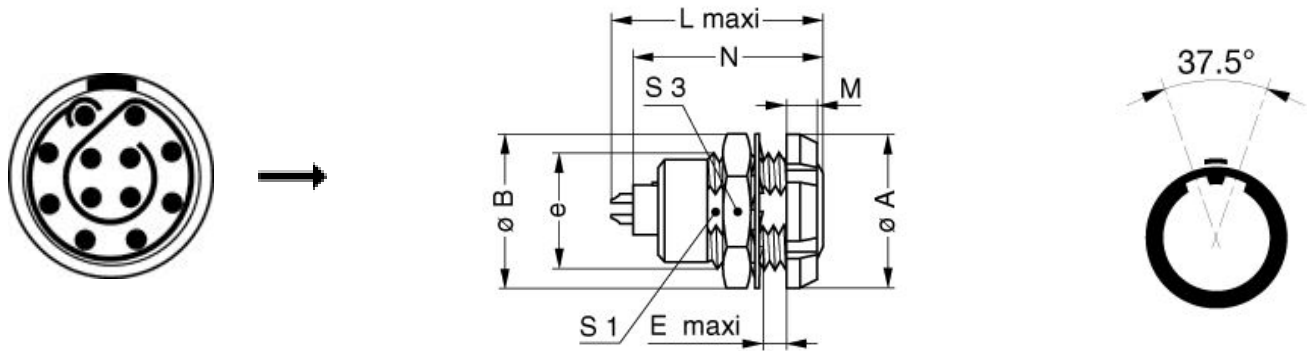

## Dimensions

|     | A    | B    | E    | L    | M    | N    | S1   | S3   | e       |
|-----|------|------|------|------|------|------|------|------|---------|
| mm. | 24   | 25   | 9    | 30.7 | 4.5  | 28.1 | 16.5 | 22   | M18x1.0 |
| in. | 0,94 | 0,98 | 0,35 | 1,21 | 0,18 | 1,11 | 0,65 | 0,87 |         |









## RECOMMENDED BY LEMO

### Tools

LEMO products and services are provided "as is". LEMO makes no warranties or representations with regard to LEMO product & services or use of them, express, implied or statutory, including for accuracy, completeness, or security. The user is fully responsible for his products and applications using LEMO components.

Crimp Tool: [DPC.91.701.V](#)  
 Crimp settings: AWG/Selector = 22-24-26/6-5-5  
 Positionner: [DCE.91.093.BVC](#)  
 Extractor: [DCF.91.093.5LT](#)  
 Replacement contact: FGG.3B.561.ZZC

## Cables

|                    |               |       |   |
|--------------------|---------------|-------|---|
| CMN.12.T22.070QGZE | TPR (medical) | Grey  |    |
| CMN.12.T28.054PGZE |               | Grey  |    |
| CMN.12.T28.054PNZE |               |       |    |
| 112240             | PTFE          | White |    |
| 112260             | PTFE          | White |    |
| 112280             | PVC           | Black |    |
| 12050              | PVC           | Black |    |
| 124080             | PVC           | Grey  |   |
| 124084             | PVC           | Black |   |
| 212220             | PVC           | Black |    |
| 212240             | PVC           | Black |   |
| 212250             | PVC           | Grey  |  |
| 212260             | PVC           | Black |  |

*LEMO products and services are provided "as is". LEMO makes no warranties or representations with regard to LEMO product & services or use of them, express, implied or statutory, including for accuracy, completeness, or security. The user is fully responsible for his products and applications using LEMO components.*

## X-ON Electronics

Largest Supplier of Electrical and Electronic Components

*Click to view similar products for [Circular Push Pull Connectors](#) category:*

*Click to view products by [LEMO](#) manufacturer:*

Other Similar products are found below :

[6407-249V-11273P](#) [6408-201V-13273](#) [6408-202V-13343](#) [6408-202V-17343](#) [EZG.0B.309.CLN](#) [FFA.2S.310.ZLA](#) [FGA.1B.307.CYCD72Z](#)  
[FGJ.1B.304.CLLD76](#) [FGJ.1B.306.CWLD72](#) [FGJ.3B.304.CYMD10Z](#) [FGJ.3B.304.CYMD82Z](#) [PCS.01.250.DLLE24](#) [PHG.0K.305.CYMC40Z](#)  
[PHG.1K.308.CLLK85](#) [PKG.M0.6BL.LZ](#) [PLC.M1.0SL.LA](#) [GMA.10.290.DN](#) [GMA.3B.090.DA](#) [PRG.M0.6GL.LC52GZ](#) [PSA.1S.275.CTLC66](#)  
[ABF.1S.250.NTA](#) [133020F](#) [1331ER193MZ](#) [1332M107MZ](#) [DTS26Z19-32JA-LC](#) [DTS26Z19-32SA](#) [DTS26Z19-32SA-LC](#) [DTS26Z23-55HA](#)  
[DTS26Z23-55HA-LC](#) [DTS26Z23-55JA-LC](#) [EAJ.1B.306.CWA](#) [ECG.XB.312.CLL](#) [1589430-2](#) [EEA.0B.305.CLN](#) [EEA.0B.309.CLL](#)  
[ELF.00.250.NTL](#) [ERA.01.250.DLL](#) [BRR.2S.200.PZVG](#) [HR10A-P](#) [CAH.M34.SLL.C72GZ](#) [CAJ.M34.SLL.C72GZ](#) [300500](#) [ESB.00.303.NLL](#)  
[EXG.0B.309.HLN](#) [FFB.1S.250.CLAC27](#) [FGA.2B.306.CYCD92](#) [FGA.2B.306.CYCD92Z](#) [FGA.XB.312.CLAD72](#) [FGJ.1B.302.CYMD62](#)  
[FGJ.3B.308.CLLD72Z](#)